

ENGINE TIMING

Alfa Romeo	138-140
Audi	141-147
BMW	148-153
Chevrolet	154
Chrysler	155
Citroën	156-162
Dacia	163
Fiat	164-169
Ford	170-175
Iveco	176
Jaguar	177-178
Land Rover	179-181
Mazda	182
Mercedes	183-184
Mini	185-187
Nissan	188-189
Opel / Vauxhall	190-195
Peugeot	196-202
Renault	203-205
Rover	206
Saab	207
Seat	208-211
Skoda	212-215
Suzuki	216
Toyota	217
Volkswagen	218-223
Volvo	224-225
Optional Extras	226-231
Engine Timing Index	232-250
OEM Cross Reference Index	251-255

KEY



DO NOT USE AIR TOOLS



FOR USE WITH PETROL ENGINES



FOR USE WITH DIESEL ENGINES

BELT

FOR USE WITH BELT DRIVEN ENGINES

CHAIN

FOR USE WITH CHAIN DRIVEN ENGINES

Alfa Romeo 1.4 T-JET Petrol Engine Timing Kit 07763300

P BELT

- Set of locking tools required for cam belt service and engine maintenance
- Applications:
Alfa Romeo Giulietta ('10-)
Alfa Romeo Mito ('08-)

- Engine Codes:
1.4T, 1.4 16v, 1.4T-JET
198A1.000, 198A4.000,
199A6.000, 199A8.000,
955A1.000



Also covers Fiat 1.2 and 1.4 models - See page 165

Spare Parts:			
Part No.	OEM Ref.	Description	Image ID
SP23171-01	1.860.992.000	Piston Height Gauge (2)	
SP23231	2.000.004.500	Crankshaft Locking Tool	
SP10229-01	2.000.015.800	Camshaft Pulley Holding Tool	
SP23171-07	1.860.987.000	Tension Tool	
SP23171-02	1.860.985.000 1.871.000.900	Camshaft Setting Tools (2)	

Alfa Romeo 1.4 Petrol Multiair Engine Timing Kit (105 - 135 - 170 hp) 07763200

P BELT

- Set of locking tools required for cam belt service and replacement
- Applications:
Alfa Romeo Giulietta ('10-)
Alfa Romeo Mito ('08-)

- Engine Codes:
1.4 (105 - 135 - 170 hp)
940A2.000, 955A2.000,
955A6.000, 955.A7000,
955A8.000



Also covers Fiat 1.4 models - See page 165

Spare Parts:			
Part No.	OEM Ref.	Description	Image ID
SP23231	2.000.004.500	Crankshaft Locking Plate	
SP23111-08	2.190.754.200	Fixing Post for Crankshaft Locking Plate	
SP8X20SKT	Bolts	Fixing Bolts for Crankshaft Locking Plate (3)	
SP23171-07	1.860.987.000	Tensioner Adjusting Tool	
SP10441	2.000.034.400	Camshaft Timing Plate	
SP8X20SKT	Bolts	Fixing Bolts for Camshaft Timing Plate (3)	

Alfa Romeo 1.8MPI Petrol Engine Timing Kit 07753900

P BELT

- Set of locking tools required for cam belt service and replacement
- Applications: Alfa Romeo 159 ('05-'10)
- Engine Code:
1.8MPI - 939A4.000

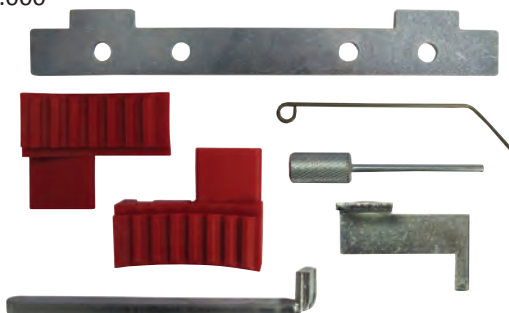

Also covers Fiat & Opel / Vauxhall models - See pages 167 & 191

Spare Parts:			
Part No.	OEM Ref.	Description	Image ID
SPE10290	2.000.012.000	Camshaft Locking Bar	
SP23056-06	2.000.012.100	Camshaft Pulley Locking Tool (2)	
SP23056-05	KM-6333	Tensioner Locking Pin	
SPE10230	2.000.012.800	Flywheel Holding Tool	
SP23174-01	KM-6349 KM-6130	Locking Pin	
SP23164-04	KM-911	Flywheel Holding Tool	

Camshaft Locking Tools

These sets of tools are designed for the precise alignment of both inlet and exhaust camshafts, as found on Alfa Romeo cars. Each set relates to a specific engine / model and it is necessary to verify the appropriate engine code prior to attempting to fit these tools.

Camshaft Locking Tool for V6 Engines (Set of 4)

SP23110-A

- Applications: Alfa Romeo 156, 166, GTV, Spider ('97-)
- Engine Codes: 2.5 V6 - 324.01, 324.05, 342.01, 343.01, 362.01
3.0 V6 - 161.02, 161.05, 343.01, 361.01
- OEM Reference: 1.825.040.000



P **BELT**

Camshaft Locking Tool for Twin Spark 1.8 / 2.0 Engines (Set of 2)

SP23110-B

- Applications: Alfa Romeo 145, 146, 147, 155, 156, 166, Spider, GTV ('95-)
- Engine Codes: 1.8 - 322.01, 322.05, 671.06
2.0 - 162.01, 323.01, 323.10, 341.03, 672.04, 363.01
- OEM Reference: 1.825.041.000



P **BELT**

Camshaft Locking Tool for Twin Spark 1.4 Engines (Set of 2)

SP23110-C

- Applications: Alfa Romeo 145, 146 ('96-)
- Engine Code: 1.4 Twin Spark - 335.03
- OEM Reference: 1.825.042.000



P **BELT**

Camshaft Locking Tool for Alfa 147 105 bhp Engines (Set of 2)

SP23110-K

- Applications: Alfa Romeo 147 ('04-)
- Engine Code: 1.6 (105 bhp) - 372.03
- OEM Reference: 1.870.797.000



P **BELT**

Camshaft Locking Tool for Alfa 147 120 bhp Engines (Set of 2)

SP23110-M

- Applications: Alfa Romeo 147, 156 ('04-)
- Engine Codes: 1.6 (120 bhp) - 321.02, 321.03, 321.04, 676.01
- OEM Reference: 1.870.734.000



P **BELT**

Camshaft Locking Tool for Alfa 2.0 JTS Engines (Set of 2)

SP23110-N

- Applications: Alfa Romeo 156 ('02-'06), GT ('04-), GTV ('03-), Spider ('03-'05)
- Engine Codes: 932A2.000, 937A1.000
- OEM Reference: 1.870.859.000



P **BELT**

Alfa Romeo 1.3 JTD Diesel Engine Timing Kit 07751800

D **CHAIN**

- Set of locking tools required for chain service and engine rebuilds
- Applications:
Alfa Romeo Mito (08-)
- Engine Codes:
1.3DJDTM / 1.3DJDTM-2 - 199A3.000, 199B1.000, 199B4.000

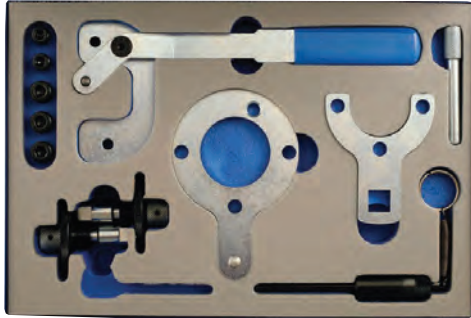

Spare Parts:

Part No.	OEM Ref.	Description	Image ID
SP23223	1.871.000.200	Crankshaft Pulley Flange Holding Wrench	
SP23222	1.870.900.400	Timing Chain Tensioner Lever	
SP23171-02	1.871.000.900	Camshaft Alignment Tool (2)	
SP23174-02	EN-46785	Flywheel Pin with Spring	
SP23069-25Z	KM613	8mm Crank Locking Pin	
SP23221	1.870.900.300	Crankshaft Timing Position Tool	

Optional Extras:

- 07752400 (1.860.831.000) - Sprocket Holding Wrench
See page 227 for further details

Alfa Romeo 1.3 JTD Diesel Engine Timing Kit 07761900

D **CHAIN**

- Set of locking tools required for chain maintenance
- Small basic set comprising of components from above kit



Alfa Romeo 1.6 - 2.4 Diesel Engine Timing Kit 07751700

D **BELT**

- Set of locking tools required for cam belt service
- Applications:
Alfa Romeo 145 / 146 ('98-) Alfa Romeo Crosswagon ('04)
Alfa Romeo 147 ('00-) Alfa Romeo Giulietta ('10)
Alfa Romeo 156 ('97-) Alfa Romeo GT ('04)
Alfa Romeo 159 ('05-) Alfa Romeo Mito ('08)
Alfa Romeo 166 ('00-) Alfa Romeo Spider ('06-)
Alfa Romeo Brera ('05-)
- Engine Codes:
1.6JTDM
940A3.000, 955A3.000, 955A4.000
1.9 JTD 8v
323.02, 371.01, 182B9.000, 937A2.000, 937A3.000, 939A1.000, 939A7.000
1.9 JTD 16v
192A5.000, 192B1.000, 937A4.000, 937A5.000
1.9 JTDM 16v
937A5.000, 939A2.000, 939A8.000
2.0 JTDM
844A2.000, 939B3.000, 939B4.000, 940A4000, 940A5000
2.4 JTD 10v
325.01, 342.02, 362.02, 839A6.000, 841C.000
2.4 JTDM 20v
841G.000, 841M.000, 939A3.000, 939A9.000, 841H.000

Spare Parts:

Part No.	OEM Ref.	Description	Image ID
SP23111-06Z	1.860.898.000	Flywheel Holding Tool	
SP23174-04X	1.870.896.900	Camshaft Alignment Pins (2)	
SP23111-08	1.860.905.000 1.860.905.010 2.000.003.000	Crankshaft Alignment Tool	
SP23069-07X	1.860.965.000	Crankshaft Alignment Pin	



**Audi 1.2 TFSI Petrol Engine Timing Kit
07763600**
P CHAIN

- Set of locking tools required for chain maintenance
- Applications:
Audi A1 / A3 ('10-)
- Engine Codes:
1.2TSI - CBZA, CBZB



Parts from kit 07763400 (below)

Spare Parts:			
Part No.	OEM Ref.	Description	Image ID
SP23191-02X	T10340	Crankshaft Locking Pin	
SPE10436	T10414	Camshaft alignment tool	
Optional Extras:			
• 07763700 (T10172) - Sprocket Holding Tool See page 230 for further details			

**Audi 1.2 TFSI, 1.4T, 1.4TFSI, 1.6 FSI Petrol Engine Timing Kit
07763400**
P CHAIN

- Set of locking tools required for chain maintenance
- Applications:
Audi A1 ('10-)
Audi A3 ('04-)
- Engine Codes:
1.2TSI - CBZA, CBZB
1.4T/FSI - CAXA, CAXC, CAVG
1.6FSI - BAG, BLP, BLF



Spare Parts:			
Part No.	OEM Ref.	Description	Image ID
SPE10436	T10414	Camshaft Locking Tool	
SP23072-A	VAS 6079	Dial Test Indicator 41 x 8mm	
SP23107-B	T10170	TDC Indicator	
SP23162-41	T10171/A	Camshaft Alignment Tool	
SP23161-06	T20046 T40011	Tensioner Pin	
SP23191-02X	T10340	Crankshaft Locking Pin	
SP23191-01	T10341	Guide Pins (2)	
Optional Extras:			
• 07763700 (T10172) - Sprocket Holding Tool See page 230 for further details			

**Camshaft Alignment Locking Tool
07756014**
P BELT

- Locking tool required for cam belt service
- Applications:
Audi A2 1.4I ('00-'05)
Audi A2 1.6FSI ('02-'05)
- Engine Codes:
1.4I - AUA, BBY
1.6FSI - BAD

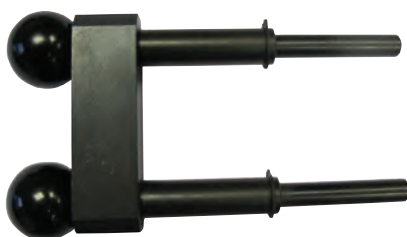

Spare Parts:			
Part No.	OEM Ref.	Description	Image ID
07756014	T10016 T10074	Camshaft Alignment Locking Tool	
Optional Extras:			
• 07767100 (3415) - Crankshaft Pulley Holding Tool See page 231 for further details			

Tool found in kit 077560V2 - see page 147

Audi 1.8, 1.8 Turbo, 2.0 Twin Camshaft Petrol Engine Timing Kit

07757200

P BELT CHAIN

- Set of tools required for belt and chain service
- Applications:
Audi A3 ('96-'03) Audi S3 ('99-'03)
Audi A4 / Quattro ('95-'08) Audi TT ('99-'05)
Audi A6 / Quattro ('95-'05)

- Engine Codes:
1.8 - ADR, AEB, AFY, AGN, AGU, AJL, AJP, AJQ, AMB, AMK, AMU, ANB, APG, APP, APT, APU, APX, APY, AQA, ARG, ARX, ARY, ARZ, AUM, AUQ, AVJ, AVV, AWT, BAM, BEX, BFB, BFW, BVP, BVR
2.0 - ALT

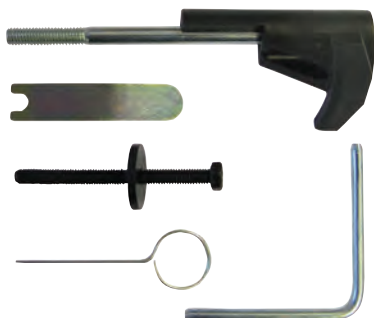

Spare Parts:			
Part No.	OEM Ref.	Description	Image ID
SP23161-06	T40011 T20046	Tensioner Locking Pin	
SP23161-93	T10092	Tensioning Bolt	
SP23161-92	3366	Chain Tensioner Retainer	
SP23069-12	T10008	Tensioner Locking Tool	
SP23161-96	T10060/A	Auxiliary Drive Belt Tensioner Pin	

Optional Extras:

- 07752400 (3036) - Sprocket Holding Wrench
- 07756005 (T10020 / V159) - Multi-Position Tensioner Wrench
- 07756900 (3369) - Guide Pin Set for Audi A4 / A6

See pages 230 - 231 for further details

Camshaft Adjustment Tool for Petrol 1.8 & 2.0 TFSI

07757300

P CHAIN

- Two in one tool for the removal of camshaft control valves prior to chain removal
- Applications:
Audi A3 ('07-)
Audi A4 / A5 / Q5 / TT ('08-) Audi Q3 ('11-)
- Engine Codes:
1.8 - BYT, BZB, CABA, CABB, CABD, CDAA, CDHA, CDHB, CJEB
2.0 - CAWB, CBFA, CCTA, CCZA, CCZC, CDNB, CDNC, CESA, CETA, CFKA, CPSA
- OEM Reference: T10352 and T10352/1



Audi 2.0T / FSI Petrol Engine Timing Kit

07756700

P BELT CHAIN

- Set of tools required for belt and chain service
- Applications:
Audi A3 ('05-'08)
Audi A4 / Cabr / Quattro ('02-'08)
Audi A6 / S3 ('06-'08)
Audi TT ('07-'10)
- Engine Codes:
2.0 FSI - AWA, AXW, BLR, BLX, BLY, BMB, BVY, BVZ
2.0 TFSI - AXX, BGB, BHZ, BPG, BPJ, BPY, BUL, BWA, BWE, BWT, BYK, BZC



Spare Parts:			
Part No.	OEM Ref.	Description	Image ID
SP23044-04	T10020	Tension Wrench	
SP23161-06	T40011	Tensioner Locking Pin	
SP23161-91	T10252	Camshaft Alignment Tool	
SP23161-92	3366	Chain Tensioner Retainer	
SP23161-93	T10092	Chain Tensioner Retaining Screw & Nut	
SP23161-96	T10060/A	Auxiliary Drive Belt Tensioner Pin	

Optional Extras:

- 07756900 (3369) - Guide Pin Set for Audi A4 / A6

See page 230 for further details

Locking tools also suitable for Audi S3 TT 2.0R with engine codes: CDLA, CDLB, CDLC, CDMA

Audi 2.4, 2.7T, 2.8 V6 Petrol Engine Timing Kit 07757400

P
BELT

- Set of locking tools required for cam belt service
- Applications:
Audi A4 ('97-)
Audi Quattro / A6 / A6 Allroad / A6 Quattro ('95-)
Audi A8 ('96) Audi RS4 ('00-'02)
Audi S4 ('97-'01)
- Engine Codes:
2.4 V6 - AGA, AJG, ALF, ALW, AML, AMM, APC, APS, APZ, ARJ, ARN, ASM, BDV
2.7T V6 - AGB, AJK, ASJ, ARE, AZA, AZB, AZR, BES
2.8 V6 - ACK, AGE, ALG, AMX, APR, AQD, ATX

Spare Parts:

Part No.	OEM Ref.	Description	Image ID
SP23056-01	3242	Crankshaft Locking Pin	
SP23056B	3391	Twin Cam Locking Strap	

Optional Extras:

- 07757500 (T40001) - Camshaft Sprocket Pulley Puller for V6 / V8 engines
 - 07756900 (3369) - Guide Pin Set for Audi A4 / A6
 - 07752400 (3036) - Sprocket Holding Wrench
 - SP23161-92 (3366) - Chain Tensioner Retainer
- See pages 230 - 231 for further details

Audi 3.0 V6 Petrol Engine Timing Kit 07756300

P
BELT

- Set of locking tools required for cam belt service
- Applications:
Audi A4 / Cabr / Quattro A6 / Quattro A8 ('01)
- Engine Codes:
3.0 V6 - ASN, BBJ

Spare Parts:

Part No.	OEM Ref.	Description	Image ID
SP23162-71	T40026	Crankshaft Aligning Tool	
SP23162-72	T40030	Camshaft Alignment Tool (2)	
SP23162-73	T40028	Camshaft Sprocket Adjusting Tool	
SP23161-06	T40011	Tensioner Locking Pin	

Optional Extras:

- 07756005 (3387 / T10020) - Multi-Position Tensioner Wrench
 - SP23161-07 (3369) - Support Guides
- See pages 230 - 231 for further details

Audi 2.4 / 3.2 FSI Petrol Engine Timing Kit 07756800

P
CHAIN

- Set of locking tools required for correct valve timing on chain driven engines
- Applications:
Audi A4 ('04-'09)
Audi A6 / Quattro ('04-'08)
Audi A8 / S8 ('05-'10)
- Engine Codes:
2.4 FSI - BDW
3.2 FSI - AUK, BKH, BPK

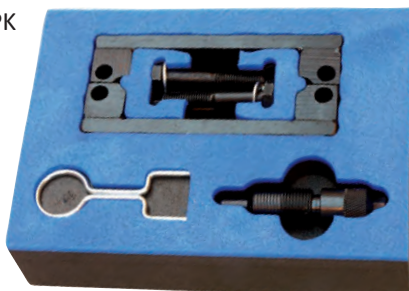
Spare Parts:

Part No.	OEM Ref.	Description	Image ID
SP23162-61	T40070	Camshaft Alignment Tool (2)	
SP23162-62	T40069	Crankshaft Alignment Tool	
SP23162-63	T40071	Timing Chain Tensioner Locking Pin	

Optional Extras:

- 07763700 (T10172) - Sprocket Holding Tool
 - SP23161-95 (T40058) - Crankshaft Turning Tool
 - SP23161-21Z (T40049) - Crankshaft Turning Tool
- See pages 230 - 231 for further details

**Audi 3.7 / 4.2 V8 Petrol Engine Timing Kit
07762700**

P BELT

- Set of locking tools required for cam belt service
- Applications:
Audi A6 / Quattro ('98-'05)
Audi A8 ('99-'08)
Audi RS6 ('03-'05)
Audi S6 ('00-'04)
Audi S8 ('99-'03)
- Engine Codes:
3.7 - AKC, AQG, BFL
4.2 - ANK, AQF, AQH, AQJ, ARU, ASG, ARS, AVP, AWN, AUW, AVN, BBD, BCY, BFM, BRV



Spare Parts:			
Part No.	OEM Ref.	Description	Image ID
SP23161-06	T40011	Tensioner Locking Pin	
SP23056-01	3242	Crankshaft Locking Pin	
SP23069-12T	T40005	Twin Cam Locking Strap	
SP23161-96T	T40009	Tensioner Adaptor	

- Optional Extras:**
- 07757500 (T40001) - Camshaft Sprocket Pulley Puller for V6 / V8 engines
 - 07756900 (3369) - Guide Pin Set for Audi A4 / A6
- See page 230 for further details*

**Audi 1.2 - 2.0TDI Diesel Engine Timing Kit
077562V2**

D BELT

- Set of locking tools required for cam belt service
- Applications:
Audi A2 ('00-'05)
Audi A3 ('01-'08)
Audi A4 / Cabr / Quattro ('99-'08)
Audi A6 / Quattro ('98-'08)
- Engine Codes:
1.2TDI PD - ANY
1.4TDI PD - AMF, ATL, BHC,
1.9TDI PD - AJM, ASZ, ATD, ATJ, AVB, AVF, AWX, AXR, BKC, BKE, BLS, BRB, BXE
2.0TDI PD - AZV, BKD, BLB, BMM, BMN, BNA, BPW, BRC, BRD, BRE, BRF, BUY, BVA, BVF, BVG



Spare Parts:			
Part No.	OEM Ref.	Description	Image ID
SP23069-11	T20102 3359	Injection Pump Timing Pin 6mm Dia.	
SP23161-94	T10115	Tensioner Locking Pin	
SP23161-03	T10050	Crankshaft Sprocket Alignment Tool	
SP23161-03C	T10100	Crankshaft Sprocket Alignment Tool	
SP23069-12	T10008	Tensioner Locking Tool	
SP23161-96	T10060/A T20167	Auxiliary Drive Belt Tensioner Pin	

- Optional Extras:**
- 07756005 (3387 / T10020) - Multi-Position Tensioner Wrench
 - SP23161-07 (3369) - Support Guides
 - 07756006 (T10264 / T10265 / T40098) Tensioner Pulley Locking Pin Set
 - 07763700 (T10172) - Sprocket Holding Tool
- See pages 230 - 231 for further details*

Components can be found in Master Kit - 077560V2 - See page 147 for details

Audi 1.6 / 2.0 Common Rail Diesel Engine Timing Kit
07757100
D BELT

• Designed to fit the newest common rail diesel engines which are significantly different from the older PD engines
 These CR engines combine belt and gear drives by using a toothed belt to transfer the drive from the crankshaft to one of the cam shafts then using gears to transfer the drive from one cam to the other

- Applications:
 Audi A1 ('10-)
 Audi A3 / A6 / Q5 / TT ('08-)
 Audi A4 ('07-)
 Audi A5 ('09-)
 Audi Q3 ('11-)

- Engine Codes:
 1.6D TDI CR - CAYB, CAYC
 2.0D TDI CR - CAGA, CAGB, CAGC, CAHA, CAHB, CBAA, CBAB, CBBB, CFFA, CFFB, CFHB, CFHD, CFGB, CFGC, CFGD, CGLA, CGLB, CGLC, CGLD, CJCA, CJC B, CJCC, CMEA, CMFA

Spare Parts:

Part No.	OEM Ref.	Description	Image ID
SP23069-11	T20102 3359	Injection Pump / Camshaft Alignment Pin	
SP23161-03	T10050	Crankshaft Pulley Locking Tool (Bored)	
SP23161-03C	T10100	Crankshaft Pulley Locking Tool (Non-bored)	
SP23161-81	T10264	Tensioner Pulley Adjustment tool (2.4mm Hex key)	
SP23161-83	T10265	Tensioner Pulley Locking Tool	
SP23161-96	T10060/A	Auxiliary Tensioner Locking Tool (3.9mm)	
SP23161-61	T10051	Sprocket Holding Tool	
SP23161-62	T10052	Cam Sprocket Hub Puller	
SP23161-17	T10255	Oil Pump / Balance Shaft Alignment	

Optional Extras:

- 07763700 (T10172) - Sprocket Holding Tool
 - 07756900 (3369) - Guide Pin Set for Audi A4 / A6
- See page 230 for further details

Audi 1.9TDI Diesel Engine Timing Kit
07757900
D BELT

• Set of locking tools required for cam belt service

- Applications:
 Audi A3 ('96-'03)
 Audi A4 / Quattro ('95-'01)
 Audi A6 / Quattro ('94-'02)

- Engine Codes:
 1.9TDI - 1Z, AFF, AFN, AGR, AHF, AHH, AHU, ALH, ASV, AVG

Spare Parts:

Part No.	OEM Ref.	Description	Image ID
SP23161-B	3418	Camshaft Aligning / Locking Tool	
SP23062-B	2065A	Camshaft Setting Bar	
SP23069-11	3359	Injection Pump Locking Pin	
SP23061-01	2064	Pump Sprocket Locking Pin	

Optional Extras:

- 07756005 (T10020 / V159) - Multi-Position Tensioner Wrench
 - 07752400 (3036) - Sprocket Holding Wrench
 - SP23161-07 (3369) - Support Guides
- See pages 230 - 231 for further details

Components can be found in Master Kit - 077560V2 - See page 147 for details

Audi 2.5TDI Diesel Engine Timing Kit 07757800

D **BELT**

- Set of locking tools required for cam belt service
- Applications:
Audi A4 / Cabr / Quattro ('97-'09)
Audi A6 / Allroad / Quattro ('97-'05)
Audi A8 ('97-'00)
- Engine Codes:
2.5TDI - AFB, AKE, AKN, AYM, BAU, BCZ, BDG, BDH, BFC



Locking tools from kit 077560V2 - see page 147

Spare Parts:			
Part No.	OEM Ref.	Description	Image ID
SP23069-11	T20102/3359	Injection Pump Timing Pin 6mm Dia.	
SP23161-06	T40011	Tensioner Pin	
SP23056-02	3458	Camshaft Alignment Plates	
SP23161-07	3369	Support Guide	
SP23056-01	3242	Crankshaft Locking Pin	
SP23161-96	T10060/A	Auxiliary Drive Belt Tensioner Pin	
Optional Extras:			
<ul style="list-style-type: none"> • 07752400 (3036) - Sprocket Holding Wrench • 07757500 (T40001) - Camshaft Sprocket Pulley Puller for V6 / V8 engines See page 230 for further details			

Audi 2.7 - 4.2 TDI Diesel Engine Timing Kit 07757700

D **CHAIN**

- Set of locking tools required for correct valve timing on chain driven engines
- Applications:
Audi A4 / Allroad / Quattro ('05-)
Audi A5 / Q5 / Q7 ('07-)
Audi A6 Allroad / Quattro ('05-)
Audi A8 ('03-)
- Engine Codes:
2.7 TDI - BPP, BSG, CAMA, CAMB, CANA, CANB, CANC, CAND, CGKA, CGKB
3.0 TDI - ASB, BKN, BMK, BNG, BUG, BUN, CAPA, CASA, CASB, CCLA, CCWA, CCWB, CDYA, CDYB, CDYC
4.0 TDI - ASE
4.2 TDI - BTR, BVN



Spare Parts:			
Part No.	OEM Ref.	Description	Image ID
SP23056-01	3242	Crankshaft Locking Pin	
SP23069-11	3359	Injection Pump / Balancer Shaft Locking Pin	
SP23161-21Z	T40049	Crankshaft Turning Tool - Type 2	
SP23161-95	T40058	Crankshaft Turning Tool - Type 1	
SP23161-22	T40060	Camshaft Locking Pin (2)	
SP23161-23Z	T40061	Camshaft Alignment / Locking Tool	
SP23161-24Z	T40062	Camshaft Sprocket Holding Tool	
SP23161-25	3.3mm Pins	Tensioning Locking Pin (2)	
Optional Extras:			
<ul style="list-style-type: none"> • SP23162-63 (T40071) - Timing Chain Tensioner Locking Pin • 07752400 (3036) - Sprocket Holding Wrench See pages 230 - 231 for further details			

Audi Petrol & Diesel Combined Engine Timing Kit 077560V2

P D BELT

- Set of locking tools required for cam belt service
- Applications:
 - Audi A2 ('00-'05)
 - Audi A3 / S3 ('96-'08)
 - Audi A4 / Cabr / Quattro ('95-'09)
 - Audi A6 / Quattro ('94-'08)
 - Audi A8 ('97-'00)
 - Audi TT ('99-'05)
- Engine Codes:
 - 1.2TDI PD - ANY
 - 1.4TDI PD - AMF, ATL, BHC
 - 1.9TDI - 1Z, AFF, AFN, AGR, AHF, AHH, AHU, ALH, ASV, AVG
 - 1.9TDI PD - AJM, ASZ, ATD, ATJ, AVB, AVF, AWX, AXR, BKC, BKE, BLS, BRB, BXE
 - 2.0TDI PD - AZV, BKD, BLB, BMM, BMN, BNA, BPW, BRC, BRD, BRE, BRF, BUY, BVA, BVF, BVG
 - 2.5TDI - AFB, AKE, AKN, AYM, BAU, BCZ, BDG, BDH, BFC
 - 1.4I - AUA, BBY
 - 1.6FSI - BAD
 - 1.8 - ADR, AEB, AFY, AGN, AGU, AJL, AJP, AJQ, AMB, AMK, AMU, ANB, APG, APP, APT, APU, APX, APY, AQA, ARG, ARX, ARY, ARZ, AUM, AUQ, AVJ, AVV, AWT, BAM, BEX, BFB, BFV, BVP, BVR
 - 2.0 - ALT



Spare Parts:			
Part No.	OEM Ref.	Description	Image ID
SP23044-01	V.159 T10020	Tension Wrench	
SP23044-03	3387 U-30009	Tension Wrench	
SP23056-01	3242	Crankshaft Locking Pin	
SP23056-02	3458	Camshaft Aligning Plates	
SP23060-F	N/A	Shim Set (2)	
SP23061-01	2064 U-20003	Injection Pump Pulley Timing Pin	
SP23062-B	2065A U-40021	Camshaft Setting Bar	
SP23069-11	3359 T20102 U-40074	Injection Pump Pulley Timing Pin	
SP23069-12	T10008 310-084 (23-058)	Tensioner Locking Tool	
SP23069-14	T10016	Camshaft Locking Tool	
SP23161-B	3418 T20038	Camshaft Setting Bar	
SP23161-03	T10050 310-085 (23-059)	Crankshaft Sprocket Alignment Tool	
SP23161-04	N/A	Set Screw	
SP23161-05	N/A	Stud & Nuts	
SP23161-06	T20046	Tensioner Pin	
SP23161-07	3369	Support Guides	
SP23161-03C	T10100	Crankshaft Sprocket Alignment Tool	
Optional Extras:			
<ul style="list-style-type: none"> • 07752400 (3036) - Sprocket Holding Wrench • 07756006 (T10264 / T10265 / T40098) Tensioner Pulley Locking Pin Set • 07763700 (T10172) - Sprocket Holding Tool • 07757500 (T40001) - Camshaft Sprocket Pulley Puller for V6 / V8 engines <i>See page 230 for further details</i>			

BMW Master Petrol & Diesel Engine Timing Kit

07758000

P D CHAIN

- Set of locking tools required for correct valve timing on chain driven engines
- Applications:
 - BMW 316 / 318 / 318TDS / 320 / 323 / 325 / 325TD / S / 328 / M3 (E36) ('91-'00)
 - BMW 316 / 320 / 323 / 325 / 328 / 330 (E46) ('99-)
 - BMW 520 / 523 / 525 / 525TD / TDS / 528 / 530 / 535 (E39) ('96-)
 - BMW 520 / 525 / 530 (E60, E61) ('03-)
 - BMW 725TDS / 728 / 735 / 740 / 750 (E38) ('94-)
 - BMW 730 (E65, E66) ('04-)
 - BMW 840 / 850 / 850CSI (E31) ('93-)
 - BMW X3 (E53) ('99-) X5 (E53) ('99-)
 - BMW Z3 ('96-) Z4 (E85) ('03-)

- Engine Codes:

1.6 - 16 4E 2/3	2.5D - 25 6T 1/L
1.7D - 17 4T 1	2.8 - 28 6S 1/23.0 - 30 6S 3
1.8 - 18 4E 2, 18 4S 1	5.0 - 50 12 A
1.9 - 19 4E 1/4S 1	5.4 - 54 12 1/2
2.0 - 20 6S 2/3/4	5.6 - 56 12 1
2.2 - 22 6S 1	
2.5 - 25 6S 1/2/3/4/5	



Spare Parts:			
Part No.	OEM Ref.	Description	Image ID
SP23048-01	11 2 300	Crankshaft TDC Setting Pin	
SP23048-02	11 3 240	Camshaft Locking Tool – exhaust	
SP23048-03	11 3 190	Camshaft Locking Tool	
SP23048-04	11 3 320	Camshaft Locking Tool	
SP23048-05	11 4 220 11 3 390	Primary Timing Chain Pre-load Tool	
SP23048-06	11 5 490	VANOS Unit Engagement Wrench	
SP23048-07	11 3 340	Tensioner Pin (2)	

Optional Extras:

- 07758800 - 2.0 - 3.0 Twin Vanos Tools
- 07758500 - Diesel Injection Pump Remover & Sprocket Retainer

See page 149 & 228 for further details

BMW 1.6 - 1.9 Petrol Engine Timing Set

07761100

P CHAIN

- Set of locking tools required for correct valve timing on chain driven engines
- Applications: BMW 316i / 318i (E36, E46) ('94-'04)
BMW 518i (E34) ('93-'96)
BMW Z3 1.8 / 1.9 (E36) ('96-'03)

- Engine Codes:

1.6 - 16 4E 2, 16 4E 3	1.8 - 18 4E 2	1.9 - 19 4E 1
------------------------	---------------	---------------

- OEM Reference: 11 3 190, 11 2 300

Note: Parts taken from Master Kit 07758000 - See above



BMW 1.6 - 2.8 Petrol Engine Timing Set

07761200

P CHAIN

- Includes twin cam setting bracket and crankshaft locking pin
- Applications: BMW 316i / 318S / TI / 320i / 323i / 325i / 328i (E36) ('90-'01)
BMW 518i / 520i / 523i / 528i (E34, E39i) ('93-'00)
BMW 728i (E38) ('94-'01)

- Engine Codes:

1.6 - M40, M43	1.9 - M44 19 4S 1	2.0 - M52 20 6S 2/3
2.5 - 25 6S 1/2/3	2.8 - 28 6S 1	

- OEM Reference: 11 3 240, 11 2 300

Note: Parts taken from Master Kit 07758000 - See above



BMW 2.0 / 2.3 / 2.5 / 3.0 Twin Vanos Petrol Engine Timing Kit
07758800
P
CHAIN

- Optional set of locking tools required for twin vanos engines

- Applications:

BMW 3 Series (E46) ('98-'07)

BMW 5 Series (E39, E60, E61) ('98-'07)

BMW 7 Series (E38, E65, E66) ('98-'05)

BMW X3 ('03-'07)

BMW X5 ('99-'07)

BMW Z3 ('99-'03)

BMW Z4 ('03-'06)

- Engine Codes:

2.0 - 20 6S 4

2.2 - 22 6S 1

2.5 - 25 6S 4, 25 6S 5

2.8 - 28 6S 2

3.0 - 30 6S 3

Spare Parts:

Part No.	OEM Ref.	Description	Image ID
077588-01	116 150	Camshaft Timing Setting Tool	
077588-02	116 180	Camshaft Sprockets Alignment Tool	
077588-03	113 450	VANOS Unit Checking Tool	

BMW 1.6 16v Twin Cam Petrol Engine Timing Kit
07758700
P
CHAIN

- Set of locking tools required for correct valve timing on chain driven engines

- Applications:

Suitable for BMW N40-N45 Engines

BMW 116i (E81, E87) ('03-'09)

BMW 316i (E46, E90) ('01-'09)

BMW 316ci (E46) ('01-'06)

BMW 316ti (E46) ('01-'05)

- Engine Codes:

1.6 - N40 B16A, N45 B16A, N45T B16AC

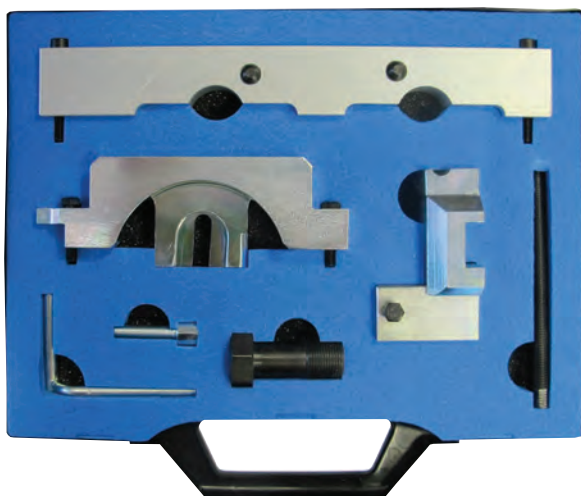
Spare Parts:

Part No.	OEM Ref.	Description	Image ID
077587-01	117 260	Sensor Gear Alignment Tool	
077587-02	117 250 / 251	Camshaft Locking Tool - Exhaust side	
077587-03	117 250 / 252	Camshaft Locking Tool - Intake side	
077587-04	119 340	Chain Tensioning Threaded Bush	
077587-05	119 340	Chain Tensioning Threaded Pin	
077587-06	117 253	Locking Screw	
077587-07	119 190 115 120	Flywheel Locking Pin	

BMW 1.6 / 2.0 N43 Petrol Engine Timing Kit
07761400

P CHAIN

- Set of locking tools required for correct valve timing on chain driven engines. Includes Vanos Sensor Alignment tool.
- Applications:
BMW 116 / 118 / 120 (E81, E87) ('07-)
BMW 316 / 318 / 320 (E90, E91, E92, E93) ('07-)
BMW 520 (E60, E61) ('07-)
- Engine Codes:
1.6 - N43 - B16A/AA/00
2.0 - N43 - B20A/AA/AY/K0/U0



Spare Parts:			
Part No.	OEM Ref.	Description	Image ID
SPE10411	11 8 690 11 8 691 11 8 692 11 8 693	Camshaft Locking Tool	
SPE10412	11 8 710 11 8 711 11 8 712	Vanos Sensor Alignment Tool	
SP23048-12	11 3 340	Chain Tensioner Locking Pins (2)	
SPE10413	11 8 700	Balance Shaft Locking Tool	
SP23048-13	11 5 120	Flywheel Locking Tool	
SP23048-14	11 9 340 11 9 341 11 9 342	Timing Chain Pre-Tensioning Tool	

BMW N42 / N46 Petrol Engine Timing Set
07758200

P CHAIN

- Set of locking tools required for correct valve timing on chain driven engines
- Applications:
BMW 118i / 120i (E81, E87) ('04-)
BMW 316i / 318i / 320 (E46) ('01-'05) (E90) ('05-)
BMW 520 (E60, E61) ('04-'08)
BMW X1 (E84) ('10-)
BMW X3 (E83) ('05-)
BMW Z4 (E85) ('04-'09)
- Engine Codes:
N42 B18A N46 B20B/O2
N42 B20A N46T B20
N46 B18 N46T B20BZ
N46 B20

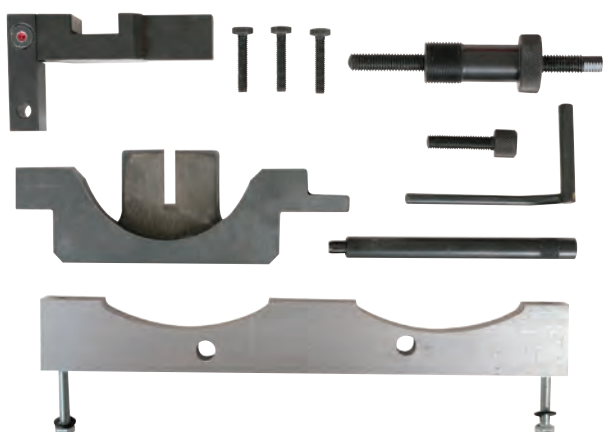

Spare Parts:			
Part No.	OEM Ref.	Description	Image ID
SP23048-01	11 2 300	Flywheel Timing Pin	
077587-07	11 9 190	Flywheel Timing Pin	
SP23048-14	11 9 340	Timing Chain Pre-Tensioning Tool	
SP23048-15	11 9 292	Inlet Camshaft Alignment Tool	
SP23048-16	11 9 350	Sensor Gear Alignment Tool	
SP23048-17	11 9 290	Exhaust Camshaft Alignment Tool	
SP23048-18	11 9 293	Camshaft Alignment Tool Bolt M8 x 25	

Optional Extras:

- 07763800 - BMW Chain Service Tool Kit
See page 228 for further details

BMW 2.5 / 3.0 Petrol Engine Timing Kit 07761500

P CHAIN

- Set of locking tools required for correct valve timing on chain driven engines. For both valvetronic and direct injection
- Applications:
 BMW 1 Series 125 / 130 / 135 (E81, E82, E87, E88) ('05-)
 BMW 3 Series 323i / 325i / 330i / 335i (E90, E91, E92, E93) ('04-'09)
 BMW 5 Series 523i / 525i / 528i / 530i (E60, E61, F10, F11)
 BMW 6 Series 630i (E63, E64) ('04-)
 BMW 7 Series 730i / 740 (E65, E66, F01, F02, F03) ('04-)
 BMW X1 (E84) ('10-) / X3 (E83, F25) ('03-) / X5 (E70) ('06-) / X6 (E71, E72) ('08-)
 BMW Z4 (E85) ('06-)
- Engine Codes:
 2.5 / 3.0 - N51, N52, N52K, N53, N54

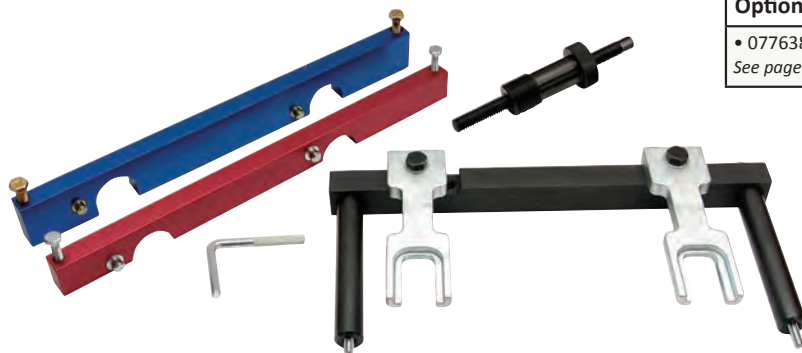

Spare Parts:			
Part No.	OEM Ref.	Description	Image ID
SP61500-01	11 0 300	Flywheel Locking Pin	
SP61500-02	11 4 281 11 4 282 11 4 283	Camshaft Alignment Tool	
SP23048-07	11 9 340	Timing Chain Pre-Tensioning Tool	
SP61500-04	11 4 290	VANOS Alignment Plate	
SP61500-05	11 8 520	VANOS Alignment Plate	
Optional Extras:			
• 07763800 - BMW Chain Service Tool Kit See page 228 for further details			

BMW V8 (N62) / V12 (N73) Petrol Engine Timing Kit 07759200

P CHAIN

- Set of locking tools required for correct valve timing on chain driven engines
- Applications:
 BMW 540 / 545 / 548 (E60, E61) ('03-)
 BMW 645 / 650 (E63, E64) ('03-)
 BMW 735, 740, 745, 750, 760 (E65, E66) ('02-)
 BMW X5 (E53, E70) ('03-)
- Engine Codes:
 3.6L - N62 B36A 4.0L - N62 B40
 4.4L - N62 B44/A 4.8L - N62 B48/A/B
 6.0L - N73 B60A



Spare Parts:			
Part No.	OEM Ref.	Description	Image ID
SP23673-01	11 9 461	Inlet Camshaft Setting Tool	
SP23673-03	11 9 462	Exhaust Camshaft Setting Tool	
SP23673-04	11 9 463	Holding Screw for Camshaft Tools	
077587-07	11 9 190	Crankshaft Pulley Setting Tool	

BMW M41 / M51 Diesel Engine Timing Kit

07767000

D CHAIN

- Set of locking tools required for correct valve timing on chain driven engines
- Applications:
BMW 318TDS (E36) ('94-'00) / 325TD / TDS (E36) ('91-'99)
BMW 525TD / TDS (E34, E39) ('90-'00)
BMW 725TDS (E38) ('96-'02)
- Engine Codes:
1.7 - 17 4T 1
2.5 - 25 6T 1, 25 6T 1L

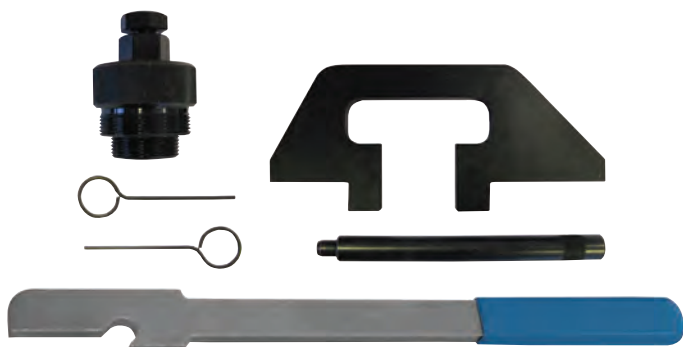

Spare Parts:			
Part No.	OEM Ref.	Description	Image ID
SP23048-01	11 2 300	Crankshaft Alignment Pin	
SP23048-12	11 3 340	Tensioner Locking Pins (2)	
SP23048-04	11 3 320	Camshaft Alignment Tool - Diesel	
SPE10369	11 3 360	Timing Chain Compressor	
SP23048-25	11 5 120	Injection Pump Puller	

BMW 2.0D / 2.5D / 3.0D Diesel Engine Timing Kit

07759000

D CHAIN

- Set of locking tools required for correct valve timing on chain driven engines
- Applications:
BMW 1 Series 118D / 120D (E87) ('03-)
BMW 3 Series 318 / 320 / 330 (E46) ('98-)
318 / 320 / 325 / 330 / 335 (E90, E91) ('05-)
BMW 5 Series 520 / 525 / 530 (E39) ('98-)
520 / 525 / 530 / 535 (E60, E61) ('04-)
BMW 6 Series 635 (E63, E64) ('07-)
BMW 7 Series 730 (E38) ('98-)
7 Series 730 (E65, E66) ('04 - '08)
BMW X3 (E83) ('04-)
BMW X5 (E53) ('00-)
X5 (E70) ('07-)
BMW X6 (E71, E72) ('08-)
- Engine Codes:
2.0D - 20 4D 1, 20 4D 4
2.5D - 25 6D 1
3.0D - 30 6D 1, 30 6D 2, 30 6D 3, 30 6D 4, 30 6D 5

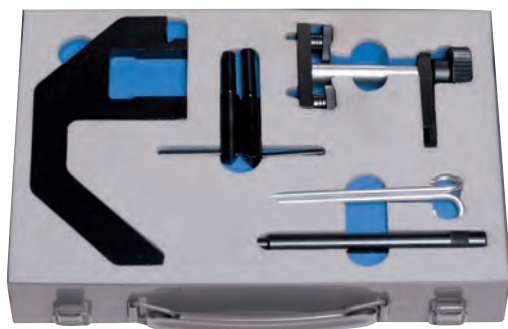





Spare Parts:			
Part No.	OEM Ref.	Description	Image ID
SP23048-01	11 2 300	Crankshaft TDC Setting Pin	
SP23048-09	11 6 320	Camshaft Setting Plate	
SP23048-11	11 6 322	Locking Clamp	
SP23048-12	11 3 340	4.0mm Tensioner Retaining Pin (2)	
SP23048-36	11 5 180	Flywheel Locking Pin Type 1	
SP23048-37S	11 6 080	Flywheel Locking Pin Type 2	

BMW 2.0 (N47 / N47S) Diesel Engine Timing Kit 07758900

D CHAIN

- Set of locking tools required for correct valve timing on chain driven engines
- Applications:
 - BMW 116D (E81, E87) ('08-)
 - BMW 118D (E81, E87) ('07-)
 - BMW 120D (E81, E87) ('07-)
 - BMW 123D (E81, E87) ('07-)
 - BMW 316D (E90) ('09-)
 - BMW 318D (E90) (07-)
 - BMW 320D (E90, E92, E93) ('07-)
 - BMW 520D (E60) ('05-) 520D (F10) ('10-)
 - BMW X1 (E84) ('07-)
 - BMW X3 (E83) ('07-) X3 (F25) ('11-)
- Engine Codes:
 - 2.0 - N47 D20, N47 D20A, N47S

Spare Parts:			
Part No.	OEM Ref.	Description	Image ID
SP23048-37	11 5 320	Flywheel Plate Timing Pin	
SP23048-35Z	11 8 760	Camshaft Alignment Tool	
SP23048-45	11 6 480	Crankshaft Pulley Turning Tool	
SP23048-46	11 8 740	High Pressure Pump Sprocket Removal Tool	
SP23048-11Z	11 3 340	Tensioner Locking Pins (2)	



**FOR THE LATEST
PRODUCT INFORMATION
VISIT OUR NEW WEBSITE:
www.sykes-pickavant.com**

Chevrolet 1.4 / 1.6 / 1.8 Petrol Engine Timing Kit
07753900

P BELT

- Set of locking tools required for cam belt service and replacement
- Applications:
Chevrolet Aveo ('08-), Cruze ('09-), Orlando ('11-)
- Engine Codes:
1.4 16v - G14D
1.6 - LDE / F16D4 / LXV
1.8 - 2HO

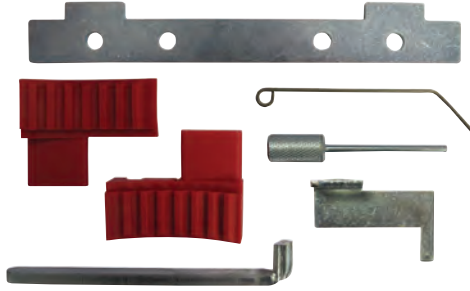

Spare Parts:			
Part No.	OEM Ref.	Description	Image ID
SPE10290	KM-6628A	Camshaft Locking Bar	
SP23056-06	EN-6340	Camshaft Pulley Locking Tool (2)	
SP23056-05	EN-6333	Tensioner Locking Pin	
SPE10230	EN-6625	Fly Wheel Holding Tool	
SP23174-01	EN-6349	Locking Pin	
SP23164-04	KM-911	Flywheel Holding Tool	

Chevrolet 1.2 / 1.4 ecoFLEX Petrol Engine Timing Kit
07763500

P CHAIN

- Set of locking tools required for correct valve timing on chain driven engines
- Applications:
Chevrolet Aveo ('11-)
- Engine Codes:
1.2 - LWD / A12 XEL / LDC / A12 XER
1.4 - LDD / A14 XEL / XER



Spare Parts:			
Part No.	OEM Ref.	Description	Image ID
SP23164-11EX	KM-953-A	Camshaft Locking Tool	
SPE10562	EN-49977-100	Camshaft Position Sensor Disc Setting Tool	
SP23164-11	KM-952	Crankshaft Locking Pin	
SPE10656	EN-49978	Camshaft Sensor Locking Tool	
SPE10329	EN-49977-200	Inlet Camshaft Adjuster Locking Tool	
SP23164-15Z	KM-955-1	Chain Tensioner Locking Pin	
SP23164-16Y	KM-955-2	Belt Tensioner Locking Pin	

Chevrolet 2.0TDCI / VCDI Sohc Petrol Engine Timing Kit
07753800

P BELT

- Set of locking tools required for cam belt service
- Applications:
Chevrolet Captive ('07-), Cruze ('09-), Epica ('06-), Lacetti ('07-), Nubira ('07-)
- Engine Codes:
2.0TDCI / VCDI - RA420, Z0S1, LLW, Z20DMH

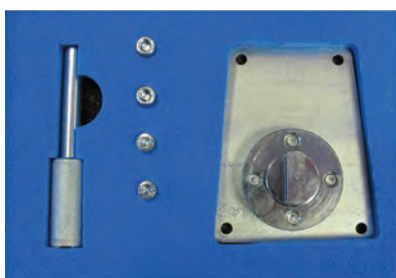

Spare Parts:			
Part No.	OEM Ref.	Description	Image ID
SP23036-02	EN-48245	Camshaft Locking Tool	
SP23036-01	EN-48246	Crankshaft Locking Pin	

Chrysler 1.8 / 2.0 / 2.4 Crankshaft Pulley Remover Adaptor & Installer Set
07761600
P BELT

- For timing belt replacement it is necessary to remove the crankshaft pulley in order to remove the timing belt
- Use in conjunction with suitable 3-leg puller
- Applications:
Chrysler Grand Voyager ('94-'08)
Chrysler Neon ('95-'04)
Chrysler PT Cruiser ('00-'09)
Chrysler Stratus ('94-'01)
Chrysler Voyager ('94-'08)
- Engine Codes:
1.8 / 2.0 / 2.4 - ENG, ECB, ECC, EDZ

Chrysler 2.5CRD / 2.8CRD Diesel Engine Timing Kit
07762000
D BELT

- Set of locking tools required for cam belt service
- Applications:
Chrysler Grand Voyager ('01-'09)
Chrysler Voyager ('01-'09)
Chrysler Jeep Cherokee ('01-'08)
LDV Maxus 2.5CRD ('05-'08)
- Engine Codes:
2.5CRD - RC2516C / R2516K / VM2516L
2.8CRD - RC2816C5 / R2816K4

Spare Parts:

Part No.	OEM Ref.	Description	Image ID
SP62001-01	VM8873	Flywheel Locking Pin (Belt Replacement)	
SP62001-02	VM1080	Flywheel Locking Pin (Belt Replacement)	
SP62001-03	VM1068 VM1089	Flywheel Locking Pin (Belt Replacement)	
SP62001-04	VM1052 LDV192	Camshaft Locking Pin (Inlet)	
SP62001-05	VM1053 LDV193	Camshaft Locking Pin (Exhaust)	
SP62001-06	VM9660 H2587	Tensioner Adjuster	
SP62001-07	N/A	Balancer Shaft Locking Pin	
SP62001-08	N/A	Balancer Shaft Locking Pin	

Chrysler 2.2 / 2.7 Petrol & Diesel Engine Timing Kit
07760000
P D CHAIN

- Set of locking tools required for correct valve timing on chain driven engines
- Applications:
Chrysler PT Cruiser ('02-'09)
Chrysler Jeep Grand Cherokee ('01-'05)
- Engine Codes:
2.2 CRD - EDJ
2.7 CRD (161hp)

Spare Parts:

Part No.	OEM Ref.	Description	Image ID
SP23241-01	8932	Flywheel Plate Locking Tool c/w Bolts M6 x 90mm (2)	
SP23241-02	8933	Flywheel Plate Locking Tool	
SP23241-03	8929	Camshaft Locking Pin Set (2)	

Citroën 1.4 (ET3) Petrol Engine Timing Kit (TU3A/JP)

07754500

P BELT

- Set of locking tools required for cam belt service
- Applications:
 Citroën Berlingo ('01-'11)
 Citroën C2 ('02-'10)
 Citroën C3 ('02-'10)
 Citroën C3 / Pluriel ('02-'10)
 Citroën Nemo ('08-'10)
 Citroën C4 ('04-'11)
- Engine Codes:
 1.4 - KFU (ET3JP4), KFV, KFW (TU3JP)

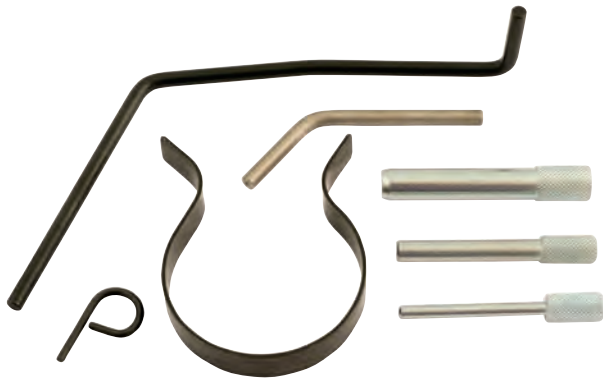

Spare Parts:

Part No.	OEM Ref.	Description	Image ID
SPE10232	4507-TA 0132-QY	Flywheel Timing Pin - 6mm dia long	
SP23069-53	4533-TAD 0132-AK 0188-K / 0189-K 0153-AK	Timing Belt Clip	
SP23069-33X	0153-AL 4200-TA	3mm Tensioner Pin	
SP23069-04	0178-D / 0194-A 0132-AB 4527-TS2 5711-TD	Camshaft Locking Pin (Inlet 16v) 5mm dia	
SP23069-25Z	0132-AJ1 0187-B / 0189-B 0188-M / 0194-B	Camshaft Locking Pin (Exhaust 16v) 8mm dia	
SP23055-02X	0132-RZ 4507-TB	Camshaft Locking Pin (8 Valve Engine) 10mm dia	
SP23055-01X	4507-TA 0132-QY	Flywheel Locking Pin - 6mm dia short	

Citroën 1.4VTI & 1.6VTI (EP3 / EP6) Petrol Engine Timing Kit

07759400

P CHAIN

- Set of locking tools required for correct valve timing on chain driven engines
- Applications:
 Citroën Berlingo III / C3 III ('09-)
 Citroën C3 / Picasso ('09-)
 Citroën C4 ('08-)
 Citroën C4 II ('11-)
 Citroën C4 Grand Picasso ('08-)
 Citroën C5 III ('09-)
 Citroën DS3 ('09-)
 Citroën DS4 ('11-)
- Engine Codes:
 1.4VTI - 8FP, 8FR, 8FS
 1.6VTI - 5FK, 5FP, 5FS, 5FW

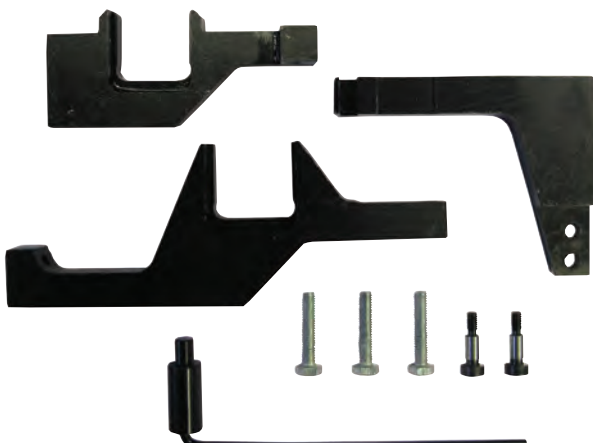

Spare Parts:

Part No.	OEM Ref.	Description	Image ID
SP23048-26	0197-A3	Inlet Camshaft Locking Tool (2 parts)	
SP23048-27	0197-A1	Camshaft Locking Tool - Exhaust	
SP23048-24	0197-B	Crankshaft Setting Pin	
SPSSM6X30	Screws	M6 Setscrews (3)	

Optional Extras:

- SP23048-14 (119-340) - Timing Chain Pre-Tensioning Tool
 See page 228 for further details

**Citroën 1.6 (EP6DT / DTS) Petrol Engine Timing Kit
07759500**
P CHAIN

- Set of locking tools required for correct valve timing on chain driven engines
- Applications:
 - Citroën C4 ('08-)
 - Citroën C4 II ('11-)
 - Citroën C4 Grand Picasso ('08-)
 - Citroën C5 III ('09-)
 - Citroën DS3/Racing ('09-)
 - Citroën DS4 ('11-)
 - Citroën DS5 ('12-)
- Engine Codes:
 - 1.6 - THP 5FD, 5FE, 5FM, 5FN, 5FR, 5FT, 5FV, 5FX



Spare Parts:			
Part No.	OEM Ref.	Description	Image ID
SP23048-21	0197-A2	Camshaft Locking Tool - Inlet	
SP23048-27	0197-A1	Camshaft Locking Tool - Exhaust	
SP23048-23	119-552	Camshaft Alignment Clamp	
SP23048-24	0197-B	Crankshaft Setting Pin	
SPSSM6X30	Screws	M6 Setscrews (3)	○○○
Optional Extras:			
• SP23048-14 (119 340) - Timing Chain Pre-Tensioning Tool See page 228 for further details			

Parts from kit 07758600 (below)

**Citroën 1.4VTI / 1.6VTI / 1.6 (EP3 / EP6 / EP6DT / DTS) Petrol Engine Timing Kit
07758600**
P CHAIN

- Set of locking tools required for correct valve timing on chain driven engines
- Applications:
 - Citroën Berlingo III / C3 III ('09-)
 - Citroën C3 / Picasso ('09-)
 - Citroën C4 ('08-)
 - Citroën C4 II ('11-)
 - Citroën C4 Grand Picasso ('08-)
 - Citroën C5 III ('09-)
 - Citroën DS3 / Racing ('09-)
 - Citroën DS4 ('11-)
 - Citroën DS5 ('12-)
- Engine Codes:
 - 1.4VTI - 8FP, 8FR, 8FS
 - 1.6VTI - 5FK, 5FP, 5FS, 5FW
 - 1.6 - THP 5FD, 5FE, 5FM, 5FN, 5FR, 5FT, 5FV, 5FX

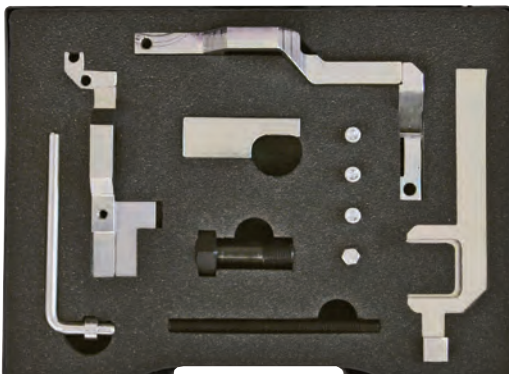

Spare Parts:			
Part No.	OEM Ref.	Description	Image ID
SPSSM6X30	Screws	M6 Setscrews (3)	○○○
SP23048-14	119-340	Timing Chain Pre-Tensioning Tool	
SP23048-24	0197-B	Crankshaft Setting Pin	
SP23048-23	119-552	Camshaft Alignment Clamp	
SP23048-26	0197-A3	Inlet Camshaft Locking Tool (2 parts)	
SP23048-21	0197-A2	Camshaft Locking Tool - Inlet	
SP23048-27	0197-A1	Camshaft Locking Tool - Exhaust	

**Citroën 1.0 - 2.0 Petrol Engine Timing Kit
07754300**

P BELT

- Set of locking tools required for cam belt service

• Applications:

- Citroën Berlingo ('97-)
- Citroën Berlingo III ('08-)
- Citroën C2 ('03-)
- Citroën C3 ('02-)
- Citroën C4 ('04-)
- Citroën Jumper / Relay ('94-)
- Citroën Saxo ('96-)
- Citroën Synergie / Evasion ('94-)
- Citroën Xantia (93-)
- Citroën XM ('89-)
- Citroën Xsara ('97-)
- Citroën Xsara II ('00-)
- Citroën Xsara Picasso ('99-)

• Engine Codes:

- 1.0L - CDY, CDZ
- 1.1L - HDY, HDZ, HFX
- 1.4L - KFW, KFX
- 1.6L - BFZ, NFR, NFS, NFT, NFU, NFV, NFX, NFZ
- 1.8L - LFW, LFX, LFY, LFZ
- 2.0L - R6A, RGX, RGY, RFN ('00-'02), RFS, RFU, RFV, RFW, RFX, RFY, RFZ



Spare Parts:			
Part No.	OEM Ref.	Description	Image ID
SP23053	0132-X 4507-TJ 9767.89	Tensioning Tool	
SP23055-01	0132-Q 5711-TA	Crankshaft Locking Pin	
SP23055-02	0132-R	Camshaft Alignment Pin (2)	
SP23055-05	0132-QZ	Crankshaft Locking Pin	
SP23055-06	0189-C	Crankshaft Locking Tool	
SP23061-02	0153-G 0153-Y 0153-N 0188-D 7004-TG 7014-TJ 7017-TR 9767.34	Crankshaft Locking Pin	
SP23069-25Z	0189-B	Camshaft Alignment Pin	
SP23069-33	0132-AJ2	Camshaft Alignment Pin	
SP23069-34	5711-TC	Camshaft Alignment Pin	
SP23069-36	0189-A	Camshaft Alignment Pin	
SP23069-37	0189-AZ	Camshaft Alignment Pin	
SP23069-46	0134-AF 0134-C	Flywheel Locking Tool	
SP23069-51	7017-TW	Tension Wrench	
SP23069-53	0132-AK 0187-J 0188-K 0189-K 4533-TAD	Belt Retention Clip	
SP23111-02	0153-A 6012-T 9765.54 9044-T	Flywheel Locking Tool	

Citroën 1.8 - 2.2 Petrol Engine Timing Kit
07754100
P BELT

- A range of timing tools for the latest EW coded PSA engines
- Applications:
 - Citroën C4 ('04-)
 - Citroën Grand Picasso ('06-)
 - Citroën C5 ('00-)
 - Citroën C5 II ('04-)
 - Citroën C5 III ('07-)
 - Citroën C8 ('02-)
 - Citroën Dispatch / Jumpy ('00-)
 - Citroën Xsara Picasso ('99-)
- Engine Codes:
 - 1.8L - 6FY, 6FZ
 - 2.0L - RFH, RFJ, RFK, RFN, RLZ
 - 2.2L - 3FZ



Spare Parts:			
Part No.	OEM Ref.	Description	Image ID
SP23055-06	0189-C	Flywheel Locking Pin	
SP23061-12	0189-R	Flywheel / Drive Plate Locking Pin	
SP23061-14	0189-S	Tensioner Adjusting Tool	
SP23061-15	0189-S2	Tensioner Locking Tool	
SP23069-04	0132-AB 4527-T-S2	Camshaft Locking Pin 5mm (2)	
SP23069-25Z	0189-B	Crankshaft Timing Pin	
SP23069-33	0132.AJ2 0188-M 4533-TAC2	Tensioner Setting Pin	
SP23069-36	0189-A	Camshaft Timing Pin	
SP23069-37	0189-AZ	Camshaft Timing Pin	
SP23069-38	0189-L	Inlet Camshaft Timing Pin (VTC)	
SP23069-53	0132.AK 0153-AK 0187-J 0188-K 0189-K 4533-TAD	Timing Belt Retaining Clip	

Citroën 1.4 / 1.6HDI Diesel Engine Timing Pin Kit
07763900
D BELT

- A set of timing pins required for belt renewal
- Applications:
 - Citroën Berlingo ('06-)
 - Citroën C1 ('05-)
 - Citroën C2 ('02-)
 - Citroën C3 ('02-)
 - Citroën C4 ('04-)
 - Citroën Grand Picasso ('06-)
 - Citroën C5 ('04-)
 - Citroën C5 III ('07-)
 - Citroën Dispatch / Jumpy ('07-)
 - Citroën Nemo ('07-)
 - Citroën Xsara Picasso ('04-)
- Engine Codes:
 - 1.4 HDI - 8HR, 8HS, 8HT, 8HV, 8HW, 8HX, 8HY, 8HZ
 - 1.6 HDI - 9HT, 9HU, 9HV, 9HW, 9HX, 9HY, 9HZ

Parts from kit 07752200 (page 175) and 07753600 (page 178)

Spare Parts:			
Part No.	OEM Ref.	Description	Image ID
SP23060-11	0194C	Flywheel Locking Pin	
SP23069-04	0194A	Camshaft / Fuel Pump Alignment Tool	
SP23069-25Z	49JE02021	Camshaft Sprocket Locking Tool	



Citroën Diesel Engine Timing Kit
07754400

D BELT

- Set of locking tools required for cam belt service
- Applications:
 - Citroën Berlingo ('96-)
 - Citroën Dispatch ('94-)
 - Citroën Evasion ('94-)
 - Citroën Jumpy ('94-)
 - Citroën Jumper ('95-)
 - Citroën Relay ('95-)
 - Citroën Saxo ('96-)
 - Citroën Synergie ('94-)
 - Citroën Xantia ('93-)
 - Citroën XM ('89-)
 - Citroën Xsara ('97-)
 - Citroën Xsara II ('00-)
- Engine Codes:
 - 1.5D - VJY, VJZ
 - 1.8D - A9A
 - 1.9D/DT - DHV, DHW, DHX, DHY, D8B, D8C, D9B, DJY, DJZ, WJY, WJZ (DW8)
 - 2.1DT - PHZ, PJZ, P8A, P8B, P8C
 - 2.2D - P9A
 - 2.5DT/TDI - THY, T8A, T9A, THX, THZ



Spare Parts:			
Part No.	OEM Ref.	Description	Image ID
SP23061-02	0153-G 0153-Y 0153-N 0188-D 7004-TG 7014-TJ 7017-TR 9767.34	Crankshaft Locking Pin	
SP23061-03	N/A	M8 x 35 Setscrew (2)	
SP23061-04	N/A	M8 x 40 Setscrew (1)	
SP23061-09	N/A	M8 x 80 Setscrew	
SP23061-06	7017-TR	Flywheel Locking Pin	
SP23061-11	0118-X	Crankshaft Locking Pin and Spring	
SP23069-25Z	0189-B 0194-B	Camshaft Alignment Pin	
SP23069-44	0178-E	Tension Wrench	
SP23069-04	0132-AB 4527-TS2 5711-TD 0194-A	Camshaft Timing Pin	
SP23069-46	0134-AF 0134-C	Flywheel Locking Tool	
SP23101	1.860.638.000	Tension Spacer	
SP23111-02	0153-A 6012-T 9765.54 9044-T	Flywheel Locking Tool	
SP23069-53	0132-AK 0187-J 0188-K 0189-K 4533-TAD	Belt Retention Clip	

Citroën 2.7 TDV6 Diesel Engine Timing Kit
07754200

D BELT

- Set of locking tools required for cam belt service
- Applications:
 - Citroën C5 III ('07-)
 - Citroën C6 ('05-)
- Engine Codes:
 - 2.7HDI - UHZ

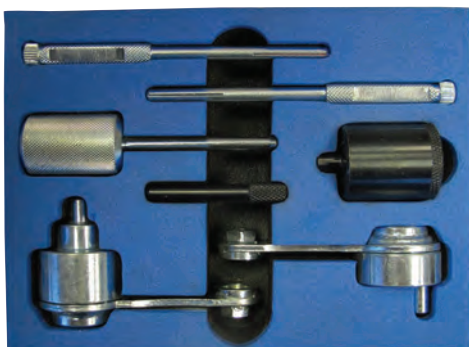

Spare Parts:			
Part No.	OEM Ref.	Description	Image ID
SP23079	303-1132	Camshaft Sprocket Alignment Tool	
SP23061-21Z	303-1126 0195-H	Camshaft Sprocket Alignment Pins (2)	
SP23079-03Y	303-1117	Flywheel Locking Tool – Automatic Transmission	
SP23079-02Z	303-1116	Flywheel Locking Tool – Manual Transmission	
SP23061-18X	0195-K	Flywheel Locking Tool	
SP23061-19X	0195-C	Coolant Pump Pulley Pin	

Citroën 2.0L / 2.2L HDI Diesel Engine Timing Kit
07764000
D BELT

- Set of locking tools required for cam belt service

- Applications:

Citroën Berlingo ('99-)
 Citroën C4 ('04-)
 Citroën C4 II ('11-)
 Citroën C4 Grand Picasso ('06-)
 Citroën C5 ('00-)
 Citroën C5 II ('04-)
 Citroën C5 ('07-)
 Citroën C6 ('06-)
 Citroën C8 ('02-)
 Citroën C-Crosser ('07-)
 Citroën Dispatch / Jumpy ('99-)
 Citroën Dispatch / Jumpy III ('10-)
 Citroën DS4 ('11-)
 Citroën DS5 ('12-)
 Citroën Jumper / Relay ('01-)
 Citroën Synergie / Evasion ('99-)
 Citroën Xantia ('98-)
 Citroën Xsara II ('99-)
 Citroën Xsara Picasso ('00-)

- Engine Codes:

2.0 / 2.2 - AHY, AHZ, RHC, RHD, RHE, RHF, RHG, RHH, RHJ,
 RHK, RHM, RHR, RHS, RHT, RHV, RHW, RHY, RHZ
 4HK, 4HL, 4HN, 4HP, 4HR, 4HS, 4HT, 4HW, 4HX, 4HY

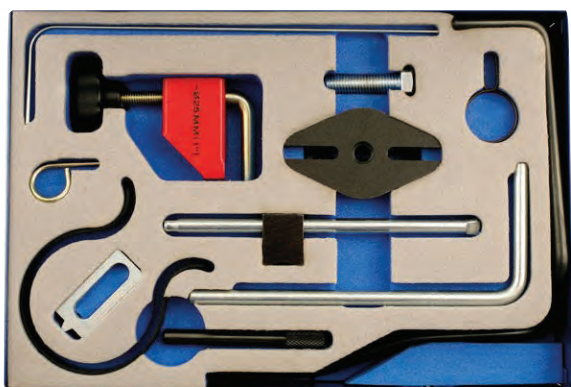

Spare Parts:			
Part No.	OEM Ref.	Description	Image ID
SP23061-07X	0188-Y	Crankshaft Locking Pin (8mm)	
SP23069-53X	0188-M	Camshaft Locking Pin	
SP23069-57	0188-X	Flywheel Locking Pin	
SPE10434	0188-Q1	Auxiliary Drive Belt Tensioner Locking Pin (4mm)	
SP23060-19Z	0188-K	Cam Belt Retaining Clip	
SP23061-24	0188-F	Flywheel Holding Tool	
SP23069-46Z	0188-J2	Cam Belt Tensioner Tool	
SP23069-49A	0188-P	Crankshaft Pulley Puller / Extractor	
SP23069-33X	0153-AL 4200-TA	Cam Belt Tensioner Locking Pin	
SPE10095-01	0188-AH	Crankshaft Pulley Centralisation Tool	
SPE10095-02	0188-AD	Cam Belt Clamp	
SP23060-08Z	0188-Q2	Auxiliary Belt Tensioner Locking & Crank Pinion Alignment Tool	

Also suitable for the following:

Fiat Ducato 2.0JTD ('02-) - RHV
 Fiat Scudo 2.0JTD ('99-) - RHZ, RHM, RHW, RHX, RHK, RHR
 Fiat Ulysee 2.0JTD ('99-) - RHZ, RHM, RHT, RHW, RHK, RHR
 Fiat Ulysee 2.2JTD ('02-) - 4HW, 4HP, 4HR, 4HS, 4HT
 Suzuki Grand Vitara 2.0D ('00-) - RHZ, RHW

Citroën 2.8D / 2.8HDI / TDI Diesel Engine Timing Kit
07751500
D BELT

- Set of locking tools required for cam belt service

- Applications:

Citroën Jumper / Relay / II ('01-)

- Engine Codes:

2.80- 8140.43, 8140.43S, 8140.63



Spare Parts:			
Part No.	OEM Ref.	Description	Image ID
SP23101	1.860.638.000	Tensioning Tool	
SP23069-23	MOT 1054	Camshaft Locking Pin	
SP23069-22	MOT 910	TDC Timing Pin (2)	

Citroën 2.2HDI / 3.0HDI Diesel Engine Timing Kit
07764500

D **BELT** **CHAIN**

- Comprehensive set of locking tools enabling correct valve timing
- Applications:
Citroën Jumper/ Relay III ('06-)
- Engine Codes:
2.2HDI - 4HG, 4HH, 4HJ, 4HM, 4HU, 4HV
3.0HDI - F1CE0381D, F1CE0381E, F1CE0481D, F1CE03481DM

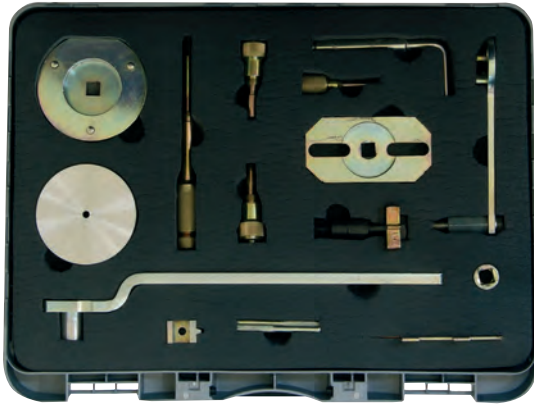

Spare Parts:			
Part No.	OEM Ref.	Description	Image ID
SP310125001	2.000.016.900	Crankshaft Seal Fitting Tool	
SP310125005	2.000.017.000	Timing Cover Centering Plate	
SP310125003	2.000.018.400	Crankshaft Pulley Turning Tool	
SP310125004	2.000.019.200	Flywheel Locking Tool	
SP310125007	2.000.016.500	Camshaft Gear Setting Rod	
SP310125009	2.000.016.700	Oil Pump Setting Plate	
SP310125010	2.000.017.300	Water Sensor Installation Socket	
SP313106000	1.860.846.000	Flywheel Locking Tool	
SP310125008	1.860.815.000	Crankshaft Pulley Mounting Plate	
SP23100-01	99360614	Camshaft Timing Pin (2)	
SP23100-02	99360615	Crankshaft Timing Pin	
SP23069-04	1.860.617.000	Injection Pump Locking Pin	
SP310125006	2.000.017.100	Flywheel Locking Tool	
SP310125002	2.000.018.700	Flywheel Locking Tool	

ENGINE TIMING



**FOR THE LATEST
 PRODUCT INFORMATION
 VISIT OUR NEW WEBSITE:
www.sykes-pickavant.com**

Dacia 1.6L Petrol Engine Timing Kit 07755100

P **BELT**

- Set of locking tools required for cam belt service
- Applications:
Dacia Duster ('10-)
Dacia Logan ('05-)
Dacia Sandero ('08-)
- Engine Codes:
1.6 - K4M606, 616, 690, 696, 697

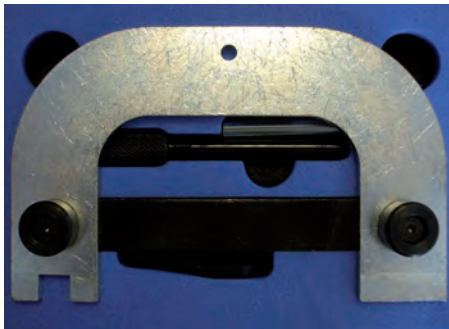

Spare Parts:			
Part No.	OEM Ref.	Description	Image ID
SP23054-04	MOT 1489	Crankshaft Timing Pin	
SP23069-23	MOT 1054	Timing Pin	
SP23069-52	MOT 1496	Camshaft Setting Tool	

Dacia 1.5DCI Diesel Engine Timing Kit 07755700

D **BELT**

- Set of locking pins required for cam belt service
- Applications:
Dacia Duster ('10-)
Dacia Sandero ('08-)
- Engine Codes:
1.5DCI - K9K 792, 796, 884, 892, 894, 896, 898



Spare Parts:			
Part No.	OEM Ref.	Description	Image ID
SP23054-04	MOT 1489	Crankshaft Timing Pin	
SP23069-23	MOT 1054	Timing Pin	
SP23069-25Z	MOT 1430	Crankshaft Timing Pin	

Fiat 0.9L Twin Air Turbo Petrol Engine Timing Kit
07763100

P CHAIN

- Allows the cam and crankshaft to be locked in position so the timing chain can be removed and re fitted
- Applications:
Fiat 500 / C 0.9 ('10-)
Fiat Panda / Punto ('12-)
- Engine Codes:
0.9 - 312A2.000



Spare Parts:			
Part No.	OEM Ref.	Description	Image ID
SP310125001X	2.000.035.300	Flywheel Locking Tool	
SP310125005X	2.000.035.200	Pulley Locking Pin	
SP310125003X	2.000.035.100	Camshaft Locking Plate with screws	

Fiat 1.2 8v Petrol Engine Timing Kit
07764300

P BELT

- Applications:
Fiat Palio / Weekend ('00-'06)
Fiat Panda ('03-)
Fiat Punto ('99-)
Fiat Strada ('00-'06)
- Engine Codes:
188A4.000
- OEM Reference: 1.870.823.000



Fiat 1.2 / 1.4 8V Petrol Engine Timing Kit
07751900

P BELT

- Set of locking tools required for cam belt service
- Applications:
Fiat 500 / C / Linea ('07-)
Fiat Doblo ('05-'10)
Fiat Florino ('09-)
Fiat Idea / Grand Punto ('05)
Fiat Punto Evo / Panda / Qubo ('09-)
- Engine Codes:
1.2 8v - 169A4.000, 199A4.000
1.4 8v - 199A7.000, 350A1.000

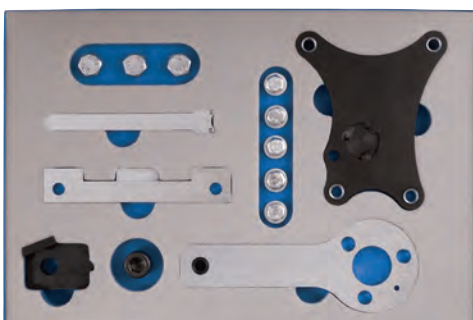

Spare Parts:			
Part No.	OEM Ref.	Description	Image ID
SP23231	2.000.004.500 2.190.754.500	Crankshaft Locking Tool	
SP23232	2.000.004.400 2.190.754.400	Camshaft Setting Bracket	
SP23233	2.000.004.200	Camshaft Sprocket Locking Tool	
SP23234	2.000.004.300	Camshaft Cover Alignment Tool	
SP23171-07	1.860.987.000	Tension Tool	

Fiat 1.2 / 1.4 16V Petrol Engine Timing Kit
07763300
P BELT

- Set of locking tools required for cam belt service and engine maintenance
- Applications:

Fiat 500 / C / Grand Punto / Linea ('07-)	Fiat Panda ('06-)
Fiat Brava / Bravo ('98-)	Fiat Palio ('01-'06)
Fiat Doblo ('10-)	Fiat Punto ('97-)
Fiat Idea ('04-)	Fiat Stilo ('01-'08)
Fiat Marea ('98-'00)	

- Engine Codes:

1.2 16v - 176B9.000, 182B2.000, 188A5.000	
1.4 16v - 169A3.000, 192B2.000, 198A1.000, 198A4.000, 199A6.000, 199A8.000, 312A1.000, 843A1.000	

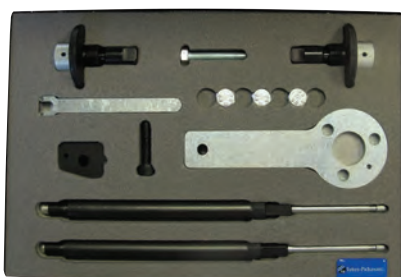

Spare Parts:			
Part No.	OEM Ref.	Description	Image ID
SP23171-01	1.860.992.000	Piston Height Gauge (2)	
SP23231	2.000.004.500	Crankshaft Locking Tool	
SPE10229-01	2.000.015.800	Camshaft Pulley Holding Tool	
SP23171-07	1.860.987.000	Tension Tool	
SP23171-02	1.860.985.000 1.871.000.900	Camshaft Setting Tools (2)	

Also covers Alfa Romeo 1.4 - See page 138 for further details
Fiat 1.4 12v Petrol Engine Timing Kit
07751A00
P BELT

- Set of locking tools required for cam belt service
- Applications:

Fiat Brava / Bravo / Marea / Weekend ('95-'00)	
--	--
- Engine Codes:

1.4 12V - 182 A3.000, 182 A5.000	
----------------------------------	--

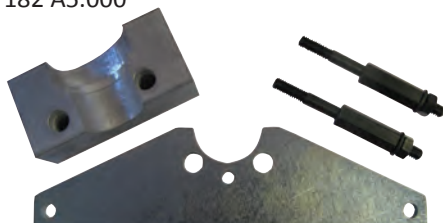

Spare Parts:			
Part No.	OEM Ref.	Description	Image ID
SP23110-G	1.860.899.000	Camshaft Timing Tool (1)	
SP23111-07	1.860.901.000	Crankshaft Timing Tool c/w studs	

Optional Extras:

- SP23107-B (1.860.443.000) - Tensioning Tool
- 07752400 (1.860.831.000) - Sprocket Holding Tool

See page 227 for further details

Fiat 1.4 Petrol Engine Timing Kit
07763200
P BELT

- Set of locking tools required for cam belt service and replacement
- Applications:

Fiat Bravo ('07)	
Fiat Punto ('12-)	
Fiat Punto Evo ('09-)	
- Engine Codes:

1.4 - 198A7.000, 955A2.000, 955A6.000	
---------------------------------------	--



Spare Parts:			
Part No.	OEM Ref.	Description	Image ID
SP23231	2.000.004.500	Crankshaft Locking Plate	
SP23111-08	2.190.754.200	Fixing Post for Crankshaft Locking Plate	
SP8X20SKT	Bolts	Fixing Bolts for Crankshaft Locking Plate (3)	
SP23171-07	1.860.987.000	Tensioner Adjusting Tool	
SP10441	2.000.034.400	Camshaft Timing Plate	
SP8X20SKT	Bolts	Fixing Bolts for Camshaft Timing Plate (3)	

**Fiat 1.6 16V Petrol Engine Timing Kit
07751B00**

P BELT

- Set of locking tools required for cam belt service
- Applications:
Fiat Brava / Bravo ('95-'02)
Fiat Doblo ('02-)
Fiat Marea / Weekend ('96-'00)
Fiat Multipla ('99-)
Fiat Palio ('00-)
Fiat Stilo ('01-)

- Engine Codes:
1.6 16V -
182A4.000
182A6.000
182B6.000



Spare Parts:			
Part No.	OEM Ref.	Description	Image ID
SP23112	1.860.874.000	Camshaft Locking Tools (A= Inlet B= Exhaust)	
SP23113	1.860.876.000	Tensioning Tool	
SP23111-04	1.860.771.000	Flywheel Locking Tool	

**Fiat 1.8 16V Petrol Engine Timing Kit
07761800**

P BELT

- Set of locking tools required for cam belt service
- Applications:
Fiat Barchetta ('00-'04)
Fiat Punto ('01-'03)
Fiat Stilo ('01-)

- Engine Codes:
1.8 16V -
183A6.000,
188A6000,
192A4.000

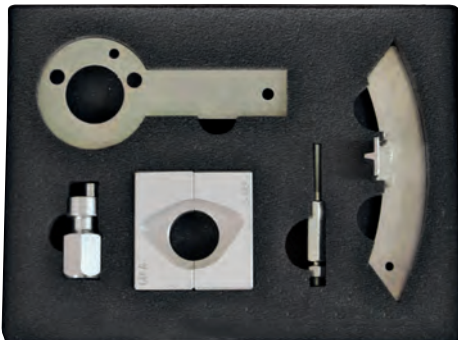

Spare Parts:			
Part No.	OEM Ref.	Description	Image ID
SP23111-08	1.860.905.000 1.860.905.010	Crankshaft Alignment Tool	
SP23111-06	1.860.898.000	Flywheel Holding Tool	
SP23110-P	1.860.697.000	Camshaft Alignment Tool	
SP23169-02	1.860.845.000	Tensioning Tool	

**Fiat 1.8 16V Petrol Engine Timing Kit
07751C00**

P BELT

- Set of locking tools required for cam belt service
- Applications:
Fiat Barchetta / Brava / Bravo ('95-)
Fiat Coupe / Marea / Weekend ('96-)
Fiat ('96-)
Fiat Punto ('99-)

- Engine Codes:
1.8 16V -
182A2.000,
183A1.000

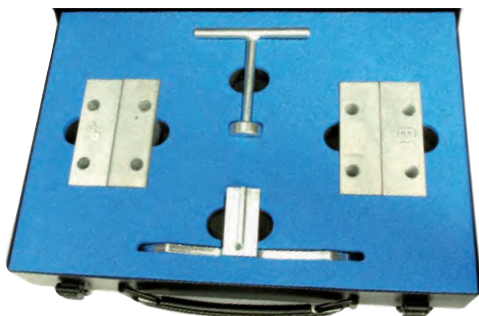

Spare Parts:			
Part No.	OEM Ref.	Description	Image ID
SP23110-D	1.860.847.000	Camshaft Alignment Tool	
SP23110-E	1.860.875.000	Camshaft Alignment Tool	
SP23111-06	1.860.898.000	Flywheel Locking Tool	
SP23169-02	1.860.845.000	Tensioning Tool	

Fiat 1.8 16V Petrol Engine Timing Kit
07753900
P BELT

- Set of locking tools required for cam belt service and replacement
- Applications:
Fiat Croma ('06-'11)
- Engine Codes:
1.8 16V - 939A4.000

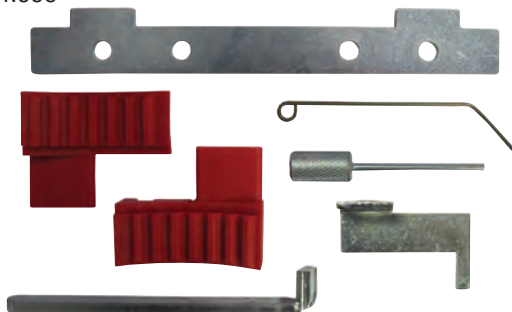

Spare Parts:			
Part No.	OEM Ref.	Description	Image ID
SPE10290	2.000.012.000	Camshaft Locking Bar	
SP23056-06	2.000.012.100	Camshaft Pulley Locking Tool (2)	
SP23056-05	KM-6333	Tensioner Locking Pin	
SPE10230	2.000.012.800	Fly Wheel Holding Tool	
SP23174-01	KM-6349 KM-6130	Locking Pin	
SP23164-04	KM-911	Flywheel Holding Tool	

Camshaft Locking Tools

These sets of tools are designed for the precise alignment of both inlet and exhaust camshafts, as found on Alfa Romeo and Fiat cars. Each set relates to a specific engine / model and it is necessary to verify the appropriate engine code prior to attempting to fit these tools.

Camshaft Locking Tool for 2.0 Non-Turbo Engines (Set of 2)
SP23110-F
P BELT

- Applications:
Fiat Bravo ('95-)
Fiat Coupe / Marea ('96-)
- Engine Codes: 175A3.000, 182A1.000, 182B3000, 182B7.000
- OEM Reference: 1860 892 000

Camshaft Locking Tool for 2.0 Turbo Engines (Set of 2)
SP23110-J
P BELT

- Applications:
Fiat Bravo ('95-)
Fiat Coupe / Marea ('96-)
- Engine Codes: 175A3.000, 182A1.000, 182B3000, 182B7.000
- OEM Reference: 1860 962 000

Fiat 2.2 16V Petrol Engine Timing Kit
07753700
P CHAIN

- Locking tool required for correct valve timing on chain driven engines
- Applications:
Fiat Croma ('05-'09)
- Engine Code:
194A1.000



Spare Parts:			
Part No.	OEM Ref.	Description	Image ID
SP23164-22	2.192.360.900	Camshaft Timing Tool	
SP23164-23	N/A	Tensioner Pin	

Fiat 1.3JTD Diesel Engine Timing Kit

07751800

D CHAIN

- Set of locking tools required for chain service and engine rebuilds
- Applications:
 Fiat 500 / C / Linea ('07-)
 Fiat Doblo / Idea ('04-)
 Fiat Fiorino / Qubo ('08-)
 Fiat Grand Punto ('05-)
 Fiat Panda / Punto ('03-)
 Fiat Punto EVO ('09-)
 Fiat Strada ('06-)

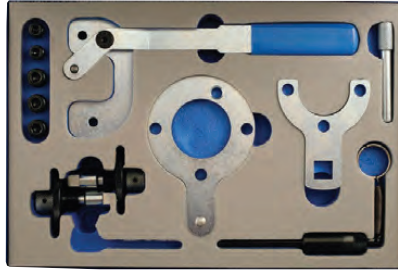

- Engine Codes:
 1.3JTD - 169A1.000,
 169A5.000, 199B1.000,
 188A8.000, 188A9.000,
 199A2.000, 199A3.000,
 199A9.000, 199B2.000,
 223A9.000, 263A2.000

Spare Parts:			
Part No.	OEM Ref.	Description	Image ID
SP23223	1.871.000.200	Crankshaft Pulley Flange Holding Wrench	
SP23222	1.870.900.400	Timing Chain Tensioner Lever	
SP23171-02	1.871.000.900	Camshaft Alignment Tool (2)	
SP23174-02	EN-46785	Flywheel Pin with Spring	
SP23069-25Z	KM-613	8mm Crank Locking Pin	
SP23221	1.870.900.300	Crankshaft Timing Position Tool	

Optional Extras:
 • 07752400 (1.860.831.000) - Sprocket Holding Wrench
 See page 227 for further details

Fiat 1.3 JTD Diesel Engine Timing Kit

07761900

D CHAIN

- Set of locking tools required for chain service
- Small basic set comprising of components from above kit



Fiat 1.6 - 2.4 Diesel Engine Timing Kit

07751700

D BELT

- Set of locking tools required for cam belt service
- Applications:
 Fiat Brava / Bravo ('95-)
 Fiat Croma / Grand Punto ('05-)
 Fiat Doblo / Stilo ('01-)
 Fiat Ducato ('11-)
 Fiat Idea ('04-)
 Fiat Linea ('08-)
 Fiat Marea ('96-)
 Fiat Punto / Multipla ('99-)
 Fiat Strada / Palio / Weekend ('00-)
 Fiat Punto Evo ('09-)
 Fiat Sedici ('06-)

- Engine Codes:
 1.6JTD - 198A2.000, 198A3.000, 198A6.000, 263A3.000,
 263A4.000, 263A5.000, 350A2.000, 955A3.000
 1.9T/D - 182A7.000, 182A8.000, 188A3.000, 223A6.000
 1.9JTD - 182B4.000, 182B9.000, 186A6.000, 186A8.000,
 186A9.000, 188A2.000, 188A7.000, 188B2.000,
 192A1.000, 192A3.000, 192A8.000, 192A9.000,
 192B4.000, 192B5.000, 199A5.000, 937A5.000,
 939A1.000
 1.9D JT/DM - 186A9.000, 192A5.000, 192A8.000, 223A7.000,
 223B1.000, 937A5.000, 939A1.000, 939A2.000,
 939A7.000, 939A8.000, D19AA
 2.0JT/DM - 198A5.000, 250A1.000, 263A1.000, D20AA
 2.4JTDM - 185A2.000, 185A6000, 939A3.000

Spare Parts:			
Part No.	OEM Ref.	Description	Image ID
SP23111-06Z	1.860.898.000	Flywheel Holding Tool	
SP23174-04X	1.870.896.900	Camshaft Alignment Pins (2)	
SP23111-08	1.860.905.000 1.860.905.010 2.000.003.000	Crankshaft Alignment Tool	
SP23069-07X	1.860.965.000	Crankshaft Alignment Pin	



Fiat Ducato 2.3JTD / 3.0JTD Diesel Engine Timing Kit
07751600
D BELT CHAIN

- Set of locking tools enabling correct valve timing
- Applications:
Fiat Ducato ('02-'09)

- Engine Codes:
2.3JTD - F1AE0481A,
F1AE0481B,
F1AE0481C,
F1AE0481D
3.0JTD - F1CE0481A



Parts from kit 07764500 (below)

Spare Parts:

Part No.	OEM Ref.	Description	Image ID
SP23069-04	1.860.617.000	Camshaft Locking Pin	
SP23057	2.000.018.200	Balancer Shaft Locking Screw	
SP23100-01	99360614	Camshaft Timing Pins (2)	
SP23100-02	99360615	Crankshaft Timing Pin	

Fiat 2.2 JTDI / 2.3 JTD / 3.0 JTD Diesel Engine Timing Kit
07764500
D BELT CHAIN

- Set of locking tools enabling correct valve timing
- Applications:
Fiat Ducato ('06-)
- Engine Codes:
2.2 JTDI - 4HV
2.3 JTD - F1AE0481A, F1AE0481B, F1AE0481C, F1AE0481D
3.0 JTD - F1CE0381D, F1CE0381E, F1CE0481D, F1CE03481DM



Spare Parts:

Part No.	OEM Ref.	Description	Image ID
SP310125001	2.000.016.900	Crankshaft Seal Fitting Tool	
SP310125005	2.000.017.000	Timing Cover Centering Plate	
SP310125003	2.000.018.400	Crankshaft Pulley Turning Tool	
SP310125004	2.000.019.200	Flywheel Locking Tool	
SP310125007	2.000.016.500	Camshaft Gear Setting Rod	
SP310125009	2.000.016.700	Oil Pump Setting Plate	
SP310125010	2.000.017.300	Water Sensor Installation Socket	
SP313106000	1.860.846.000	Flywheel Locking Tool	
SP310125008	1.860.815.000	Crankshaft Pulley Mounting Plate	
SP23100-01	99360614	Camshaft Timing Pin (2)	
SP23100-02	99360615	Crankshaft Timing Pin	
SP23069-04	1.860.617.000	Injection Pump Locking Pin	
SP310125006	2.000.017.100	Flywheel Locking Tool	
SP310125002	2.000.018.700	Flywheel Locking Tool	

Fiat 2.5 / 2.8 Diesel Engine Timing Kit
07751500
D BELT

- Set of locking tools required for cam belt service
- Applications:
Fiat Ducato ('94-)

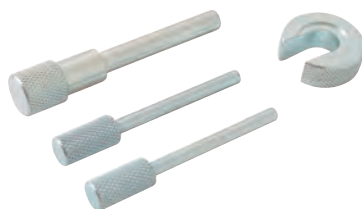
- Engine Codes:
2.5D/DT - 8140.47,
8140.47,
8140.47R
2.8D/JTD - 8140.43,
8140.43N, 8140.43S, 8140.63

Spare Parts:

Part No.	OEM Ref.	Description	Image ID
SP23101	1.860.638.000	Tensioning Tool	
SP23069-23	MOT 1054	Camshaft Locking Pin	
SP23069-22	MOT 910	TDC Timing Pin (2)	

Ford 1.2 Petrol Engine Timing Kit
07751900

P BELT

- Set of locking tools required for cam belt service
- Applications:
Ford Ka ('09-)
- Engine Code:
1.2 - AAAA



Spare Parts:			
Part No.	OEM Ref.	Description	Image ID
SP23231	303-1480	Crankshaft Locking Tool	
SP23232	303-1479	Camshaft Setting Bracket	
SP23233	303-1477	Camshaft Sprocket Locking Tool	
SP23234	303-1478	Camshaft Cover Alignment Tool	
SP23171-07	1.860.987.000	Tension Tool	

Ford 1.25 - 2.3 Petrol Engine Timing Kit
077523V2

P BELT CHAIN

- Set of locking tools enabling correct valve timing
- Applications:
Ford Cougar ('98-'01)
Ford Fiesta IV ('95-'02)
Ford Fiesta V ('02-'08)
Ford Fiesta VI ('08-)
Ford Focus ('98-'05)
Ford Focus ('04-)
Ford Focus C Max ('03-)
Ford Fusion / Transit Connect ('02-)
Ford Galaxy / S Max / Transit ('06-)
Ford Mondeo ('03-)
Ford Puma ('07-)

- Engine Codes:
1.25 (Belt) - DHA/B/C/D/E/F/G, FUJA/B, F8JA/B, M7JA/B, SNJA/B, STJA/B
1.4 (Belt) - ASDA/B, FHA/D/E/F, FXJA/B/C, SPJA/C, RTJA/B, FXDA/B/C/D, UTJA
1.6 (Belt) - FYDA/B/C/D/H, FYJA/B, C, HWDA/B, L1F, L1J, L1L, L1N, L1Q, L1T/V, L1W, SHDA/B/C
1.7 (Belt) - MHA, MHB
1.8 (Belt) - EYDB/C/D/E/F/G/H/J/L, EYPA/C, RKA/B/F/J/H/K
1.8 (Chain) - CDBB, CGBA/B, CHBA/B, CSDA/B, QQDA/B/C, Q7DA
2.0 16V (Belt) - ALDA, EDDB/B/C/D, EDDB/C/D/F, HMDA, NGA/B/C/D
2.0 16V (Chain) - CJBA/B, N4JB, AOBA, AOCA, AODA/B/E, AOWA, AOWB, SYDA, TBWA/B, TBBA/B
2.3 16v (Chain) - GZFA/B/C, SEBA, SEWA

Spare Parts:			
Part No.	OEM Ref.	Description	Image ID
SP23054-02X	21.210 303-507	Crankshaft Timing Pin	
SP23054-05	303-748	Crankshaft Timing Pin	
SP23054-03	21-163 303-620	Crankshaft Timing Pin	
SP23054-06	21-162B 303-376B	Camshaft Alignment Bar	
SP23161-94	303-1054	Tensioner Locking Pin	



Parts from kit 07752600 (see page 171)

Ford Petrol Engine Timing Kit
07752600
P
BELT
CHAIN

- Set of locking tools enabling correct valve timing

- Applications:

Ford Cougar ('98-'01)
 Ford Fiesta IV ('95-'02)
 Ford Fiesta V ('02-'08)
 Ford Fiesta VI ('08-)
 Ford Focus ('98-'05)
 Ford Focus ('04-)
 Ford Focus C Max ('03-)
 Ford Fusion / Transit Connect ('02-)
 Ford Galaxy / S Max / Transit ('06-)
 Ford Mondeo ('03-)
 Ford Puma ('07-)

- Engine Codes:

1.25 (Belt) - DHA/B/C/D/E/F/G, FUJA/B, F8JA/B, M7JA/B, SNJA/B, STJA/B
 1.4 (Belt) - ASDA/B, FHA/D/E/F, FXJA/B/C, SPJA/C, RTJA/B, FXDA/B/C/D, UTJA
 1.6 (Belt) - FYDA/B/C/D/H, FYJA/B, C, HWDA/B, L1F, L1J, L1L, L1N, L1Q, L1T/V, L1W, SHDA/B/C
 1.6 TI VCT (Belt) - HXJA, HHJB, RVJA, HXDA/B, SIDA, IQDA, IQDB, MUDA, PNDA, XTDA, KGBA, PNBA, RHBA
 1.7 (Belt) - MHA, MHB
 1.8 (Belt) - EYDB/C/D/E/F/G/H/J/L, EYPA/C, RKA/B/F/J/H/K
 1.8 (Chain) - CDBB, CGBA/B, CHBA/B, CSDA/B, QQDA/B/C, Q7DA
 2.0 16V (Belt) - ALDA, EDDB/B/C/D, EDDB/C/D/F, HMDA, NGA/B/C/D
 2.0 16V (Chain) - CJBA/B, N4JB, AOA, AOCA, AODA/B/E, AOWA, AOWB, SYDA, TBWA/B, TBBA/B
 2.3 16v (Chain) - GZFA/B/C, SEBA, SEWA

Spare Parts:

Part No.	OEM Ref.	Description	Image ID
SP23054-02X	21.210 303-507	Crankshaft Timing Pin	
SP23054-05	303-748	Crankshaft Timing Pin	
SP23054-03	21-163 303-620	Crankshaft Timing Pin	
SP23054-06	21-162B 303-376B	Camshaft Alignment Bar	
SP 23161-94	303-1054	Tensioner Locking Pin	
SP23060-21	303-1097	Camshaft Sprocket Locking Tool	
SP23161-06	N/A	Tensioner Locking Pin	

Optional Extra: 07762100 Ford Flywheel Locking Tool required for Ford 1.6 TI VCT engines

- Engine Codes: HXJA, HHJB, RVJA, HXDA, SIDA, IQDA, IQDB, MUDA, PNDA, XTDA, KGBA, PNBA, RHBA
- OEM Reference: 303-393/0

Ford Mondeo 1.8 Petrol Engine Timing Kit
07764400
P
CHAIN

- Set of locking tools required for correct valve timing on chain driven engines

- Applications:

Ford Mondeo 1.8 ('03-'07)

- Engine Code:

1.8 - CFBA



Spare Parts:

Part No.	OEM Ref.	Description	Image ID
SPE10450	303-1061	Camshaft Locking Plate	
SP23054-06	303-376B	Camshaft Alignment Bar	
SP23054-03	21-163	Crankshaft Timing Pin	
SP23054-02X	21-210	Timing Pin	

Ford Ka 1.3TDCi Diesel Engine Timing Kit
07751800

D CHAIN

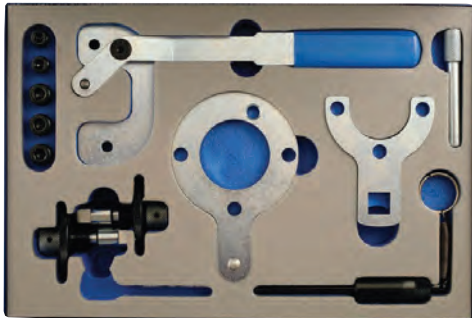
- Set of locking tools required for chain service and engine rebuilds
- Applications:
Ford Ka ('09-)
- Engine Codes:
1.3TDCi - BAAA, BAAB



Spare Parts:			
Part No.	OEM Ref.	Description	Image ID
SP23223	1.871.000.200	Crankshaft Pulley Flange Holding Wrench	
SP23222	303-1469	Timing Chain Tensioner Lever	
SP23171-02	303-1472	Camshaft Alignment Tool (2)	
SP23174-02	EN-46785	Flywheel Pin with Spring	
SP23069-25Z	KM-613	8mm Crank Locking Pin	
SP23221	303-1468	Crankshaft Timing Position Tool	

Optional Extras:

- 07752400 (15-030-A / 205-072) - Sprocket Holding Wrench
See page 229 for further details

Ford 1.4 - 2.2 Diesel Engine Timing Kit
07752700

D BELT CHAIN

- Set of locking tools enabling correct valve timing
- Applications:

Ford Fiesta V ('04-'08)	Ford Fusion ('02-)
Ford Fiesta VI / Kuga ('08-)	Ford Galaxy / S Max ('06-)
Ford Focus ('04-)	Ford Mondeo ('93-)
Ford Focus C Max ('03-)	Ford S Max ('11-)
Ford Focus C Max Grand ('10-)	Ford Transit ('00-)
- Engine Codes:
 1.4TDCI - F6JA, F6JB, F6JC, F6JD
 1.6TDCI - G8DA, G8DB, G8DD, G8DE, G8DF, GPDA, GPDC, HHDA, HHDB, HHJA, HHJB, HHJC, HHJD, HHJE, HHJF, MTDA, TZJA, TZJB, T1BA, T1BB, T1BC, T1DA, T1DB, T3DA, T3DB, UBJA
 1.8D/TCI - RTJ.RTK, RFM, RFN
 2.0 16V TDCI - AZBA/C, AZWA/C, G6DA/B/C/D/E/F/G, FMBA/B, FIFA, HJBA/B/C/E, IXDA, KLBA, KLWA, LPBA, N7BA/B, QXBA/B, QXWA/B, SDBA, TXBA, TXDA/B, TXWA, TYBA, TYDA, TYWA, UFBA, UFDA/B, UFWA, UKBA, UKDA/B, UKWA
 2.0 TDDI - ABFA, D3FA, F3FA
 2.0 16V TDDI - D5BA, D6BA
 2.2DTDCI - QJBA/B/C/D



Spare Parts:			
Part No.	OEM Ref.	Description	Image ID
SP23054-06	21-162B 303-376	Camshaft Alignment Plate	
SP23060-S	21-104 303-193	Crankshaft TDC Alignment Pin	
SP23060-10	21-168A 303-393 (-01 & -02)	Flywheel Locking Tool	
SP23060-11	21.262	Camshaft Alignment Pin	
SP23060-12	21-234	Crankshaft TDC Alignment Pin	
SP23060-14	21-251 303-698	Crankshaft TDC Alignment Pin	
SP23060-19	303-1059	Crankshaft TDC Alignment Pin	
SP23069-04	21-260	Crankshaft TDC Alignment Pin	
SP23060-01	23-019	Injection Pump Alignment Pin	
SP23069-25Z	303-735	Camshaft Alignment Pin	
SP23069-35	23-029	Camshaft Alignment Pin	
SP23061-01	23-047	Injection Pump Alignment Pin	
SP23062-B	21-105	Camshaft Setting Bar	

Optional Extras:

- 07752400 (15-030-A / 205-072) - Sprocket Holding Wrench
See page 229 for further details

**Ford 1.8 TDDi / TDCi Diesel Engine Timing Kit
07752500**
D BELT CHAIN

- Set of locking tools enabling correct valve timing
- Applications:
 - Ford Fiesta IV ('98-)
 - Ford Focus C Max ('03-)
 - Ford Galaxy / S Max ('06-)
 - Ford Mondeo ('07-)
 - Ford Transit Connect ('02-)
- Engine Codes:
 - 1.8D/DT - C9DC, RTN, RTQ, RTP
 - 1.8 DuraTorq TDCi - BHPA, F9DA, F9DB, FFBA, FFDA, FFWA, HCPA, HCPB, KHBA, KKDA, KKDB, P7PA, P9PA, QYBA, QYWA, RWPA, RWPC, R2PA, R3PA, R9PB
 - 1.8D Endura TDDi - C9DA, C9DB, C9DC, BHDA, BHDB



Spare Parts:			
Part No.	OEM Ref.	Description	Image ID
SP23054-06	21-162B 303-367 303-376B	Camshaft Alignment Plate	
SP23060-S	21-104 303-193	Crankshaft TDC Alignment Pin	
SP23060-03	6mm Drill Bit	Camshaft Alignment Pin	
SP23060-10	21-168A 303-393	Flywheel Locking Tool	
SP23060-16	21-229 303-651	Camshaft Sprocket Puller	
SP23060-17	23-067 303-095	Fuel Sprocket Remover	
SP23060-18	21-230 303-652	Chain Cover Alignment Tool	
Optional Extras:			
• 07752400 (15-030-A / 205-072) - Sprocket Holding Wrench See page 229 for further details			

**Ford 1.8 TDCi / TDDi Diesel Engine Timing Kit
07762200**
D BELT

- Set of locking tools required for cam belt service
- Applications:
 - Ford Fiesta, Focus, C Max, Tourneo,
 - Transit Connect ('00 - '08)
- Contents from 07752500 - kit above

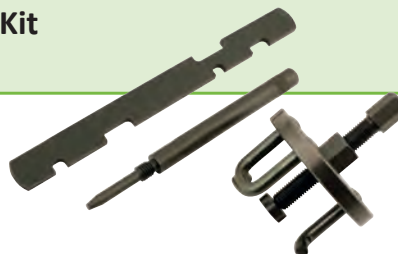
**Ford 1.8 TDCi / TDDi Diesel Engine Timing Kit
07762100**
D BELT CHAIN

- Set of locking tools enabling correct valve timing
- Applications:
 - Ford Fiesta, Focus, C Max, Tourneo,
 - Transit Connect ('00 - '08)
- Contents from 07752500 - kit above

**Ford 1.8 TDCi / TDDi Diesel Engine Timing Kit
07762300**
D CHAIN

- Set of locking tools enabling correct valve timing
- Applications:
 - Ford Fiesta, Focus, C Max, Tourneo,
 - Transit Connect ('00 - '08)
- Contents from 07752500 - kit above



Ford 2.2 TDCi Diesel Engine Timing Kit
07752800

D BELT

- Set of locking tools required for cam belt service
- Applications:
Ford Galaxy / Mondeo / S Max ('08-)
- Engine Codes:
2.2 TDCi - KNBA/B, KNWA, Q4BA, Q4WA

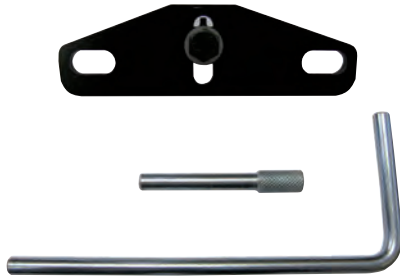

Spare Parts:			
Part No.	OEM Ref.	Description	Image ID
SP23069-25Z	303-1277	Camshaft Pulley Timing Pin	
SP23069-57	303-1270 303-1059	Flywheel Locking Timing Pin	
SP23060-10	303-1272	Flywheel / Ring Gear Locking Tool Adaptor	

Ford Transit 2.2 / 3.2 TDCi Diesel Engine Timing Kit
07764500

D BELT CHAIN

- Set of locking tools enabling correct valve timing
- Applications:
Ford Transit 2.2TDCi ('06-)
Ford Ranger 3.2TDCi ('11-)
- Engine Codes:
2.2TDCi - CYFA/B/C, DRFA/B/C, P8FA/B, PGFA/B, QVFA, QWFA, SRFA/B/C/D/E, UHFA, AJQJ, AJPF, AJQW
3.2TDCi - SAFA

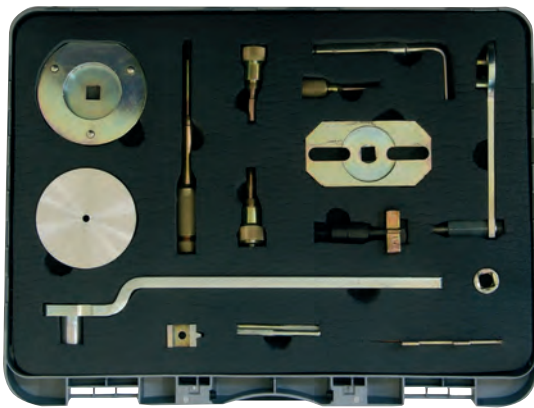

Spare Parts:			
Part No.	OEM Ref.	Description	Image ID
SP310125001	2.000.016.900	Crankshaft Seal Fitting Tool	
SP310125005	2.000.017.000	Timing Cover Centering Plate	
SP310125003	2.000.018.400	Crankshaft Pulley Turning Tool	
SP310125004	2.000.019.200	Flywheel Locking Tool	
SP310125007	2.000.016.500	Camshaft Gear Setting Rod	
SP310125009	303-705	Oil Pump Setting Plate	
SP310125010	2.000.017.300	Water Sensor Installation Socket	
SP313106000	1.860.846.000	Flywheel Locking Tool	
SP310125008	1.860.815.000	Crankshaft Pulley Mounting Plate	
SP23100-01	99360614	Camshaft Timing Pin (2)	
SP23100-02	99360615	Crankshaft Timing Pin	
SP23069-04	1.860.617.000	Injection Pump Locking Pin	
SP310125006	2.000.017.100	Flywheel Locking Tool	
SP310125002	2.000.018.700	Flywheel Locking Tool	

Ford 1.4TDCI and 2.4TD Diesel Engine Timing Kit 07752200
D CHAIN

- Set of locking tools enabling correct valve timing and pump removal
- Applications:

Ford Fiesta V ('04-'08)	Ford Galaxy / S Max ('06-)
Ford Fiesta VI ('08-)	Ford Kuga ('08-)
Ford Focus ('04-)	Ford Mondeo ('93-)
Ford Focus C Max ('03-)	Ford Mondeo ('11-)
Focus C Max Grand ('10-)	Ford S Max ('11-)
Ford Fusion ('02-)	Ford Transit ('00-)

- Engine Codes:
 - 1.4TDCI - F6JA, F6JB, F6JC, F6JD
 - 1.6TDCI - G8DA, G8DB, G8DD, G8DE, G8DF, GPDA, GPDC, HHDA, HHDB, HHJA, HHJB, HHJC, HHJD, HHJE, HHJF, MTDA, TZJA, TZJB, T1BA, T1BB, T1BC, T1DA, T1DB, T3DA, T3DB, UBJA
 - 2.0DI - ABFA, D3FA, F3FA
 - 2.0TDCI - FMBA/B, FIFa, HJBA/B/C/E, N7BA/B, SDBA
 - 2.0TDDI - D5BA, D6BA
 - 2.2TDCI - QJBA
 - 2.4DDI - D0FA, D2FA/B, D4FA, F4FA, FXFA
 - 2.4TDCI - H9FA/B/D, JXFA/C, PHFA/C



Spare Parts:			
Part No.	OEM Ref.	Description	Image ID
SP23060-02	N/A	Camshaft Sprocket Alignment Pin 6mm	
SP23069-04	0194A 21-260 303-732	Crankshaft / Fuel Pump Alignment Pin 5mm (2)	
SP23060-11	0194C 21-262 303-734	Flywheel Locking Pin 11mm	
SP23069-25Z	0194B 21-263 303-735	Camshaft Sprocket Locking Pin 8mm	
SP23060-12	21-234	Flywheel Locking Pin 14mm	
SP23060-14	21-251 303-698	Flywheel Locking Pin	
SP23175-02	21-238	Fuel Pump Cover Removal Tool	
SP23175-01	303-1151	Locking Tool, Fuel Injection Pump Sprocket	
SP23002-45C	310-083A	Key for TX45 Torx Fasteners	
SP23161-06	N/A	Tensioner Pin	
Optional Extras:			
<ul style="list-style-type: none"> • 07752400 (15-030-A / 205-072) - Sprocket Holding Wrench • 07762400 (303-249 / 303-249-01) - Ford Transit Fuel Injection Pump Puller • 07762500 (303-679A) - Pump Sprocket Holder & Pump Cover Tool See page 229 for further details			

Ford 1.4TDCI and 1.6TDCI / ECO Diesel Engine Timing Kit 07763900
D BELT

- Set of locking pins required for cam belt service
- Applications:

Ford Fiesta V ('04-'08)	
Ford Fiesta VI ('08-)	
Ford Focus ('04-)	
Ford Focus C Max ('03-)	
Ford Focus C Max Grand ('10-)	
Ford Fusion ('02-)	
Ford Galaxy / Mondeo / S Max ('11-)	



- Engine Codes:
 - 1.4TDCI - F6JA, F6JB, F6JC, F6JD
 - 1.6TDCI - G8DA, G8DB, G8DD, G8DE, G8DF, GPDA, GPDC, HHDA, HHDB, HHJA, HHJB, HHJC, HHJD, HHJE, HHJF, MTDA, TZJA, TZJB, T1BA, T1BB, T1BC, T1DA, T1DB, T3DA, T3DB, UBJA

Spare Parts:			
Part No.	OEM Ref.	Description	Image ID
SP23069-04	21-260 303-732	Crankshaft TDC Pin	
SP23060-11	21-262 303-734	Camshaft Alignment Pin	
SP23069-25Z	21-263 303-735	Camshaft Alignment Pin	

Parts from kit 07752200 (above) and 07753600 (page 178)

Optional Extra: 07762100 - Ford Flywheel Locking Tool required for Ford 1.6TDCI engines

- OEM Reference: 303-393/0



Iveco 2.5D / 2.8D Diesel Engine Timing Kit
07751500

D BELT

- Set of locking tools required for cam belt service
- Applications:
Iveco Daily / Turbo ('91-'06)

- Engine Codes:
2.5D - 8140.07/21/27S/47/
47R/67F/97
2.8D/TDI - 8140.23/43B/
43C/43N/43R/
43S/63

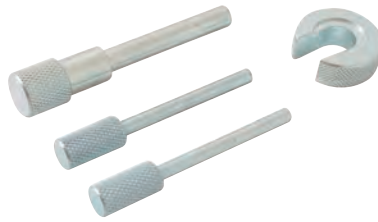

Spare Parts:			
Part No.	OEM Ref.	Description	Image ID
SP23101	1.860.638.000	Tensioning Tool	
SP23069-23	MOT 1054	Camshaft Locking Pin	
SP23069-22	MOT 910	TDC Timing Pin (2)	

Iveco 2.3JTD and 3.0JTD Diesel Engine Timing Kit
07764500

D BELT CHAIN

- Set of locking tools enabling correct valve timing
- Applications:
Iveco Daily 2.3JTD ('03-)
Iveco Daily 3.0JTD ('04-)
Iveco Eco Daily 2.3D ('09-)

- Engine Codes:
Daily 2.3HPI/HPT (Belt) ('03-)
F1AE0481A, F1AE0481B, F1AE0481D, F1AE0481F,
F1AE0481G, F1AE0481H, F1AE0481R
Daily 3.0HPI/HPT (Chain) ('04-)
F1CE0441F, F1CE0481A, F1CE0481B, F1CE0481F, F1CE0481H
Eco Daily 2.3D (Belt/Chain) ('09-)
F1CE0481FA, F1CE0481GA, F1CE0481HA, F1CE0481RA,
F1CE0481UA, F1CE0481VA

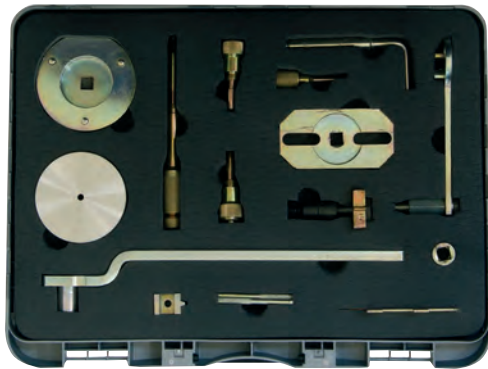

Spare Parts:			
Part No.	OEM Ref.	Description	Image ID
SP310125001	2.000.016.900	Crankshaft Seal Fitting Tool	
SP310125005	2.000.017.000	Timing Cover Centering Plate	
SP310125003	2.000.018.400	Crankshaft Pulley Turning Tool	
SP310125004	2.000.019.200	Flywheel Locking Tool	
SP310125007	2.000.016.500	Camshaft Gear Setting Rod	
SP310125009	2.000.016.700	Oil Pump Setting Plate	
SP310125010	2.000.017.300	Water Sensor Installation Socket	
SP313106000	1.860.846.000	Flywheel Locking Tool	
SP310125008	1.860.815.000	Crankshaft Pulley Mounting Plate	
SP23100-01	99360614	Camshaft Timing Pin (2)	
SP23100-02	99360615	Crankshaft Timing Pin	
SP23069-04	1.860.617.000	Injection Pump Locking Pin	
SP310125006	2.000.017.100	Flywheel Locking Tool	
SP310125002	2.000.018.700	Flywheel Locking Tool	

Iveco 2.3JTD and 3.0JTD Diesel Engine Timing Kit
07751600

D BELT CHAIN

- Set of locking tools enabling correct valve timing
- Applications: As per kit above
- Includes parts from 07764500 kit - above
 - Camshaft Locking Pin
 - Camshaft Timing Pins (2)
 - Balancer Shaft Locking Screw
 - Crankshaft Timing Pin



**Jaguar 3.2 - 4.2 Petrol Engine Timing Kit
07763000**
P CHAIN

- Set of locking tools required for correct valve timing on chain driven engines
- Applications:
Jaguar S-Type ('99-)
Jaguar XF ('08-)
Jaguar XJ8 / XK8 ('97-)
Jaguar XKR / XJR ('98-)
- Engine Codes:
3.2 - AC, KB, KC
3.5 - RB
4.0 - BC, CC, CE, DC, EC, GB, GC, LB, LC, MA, MB, NB, NC, PA, PB
4.2/R - 1B, 2B, 3B, 1G, HB, PC, SB, TB, 5G, 9G

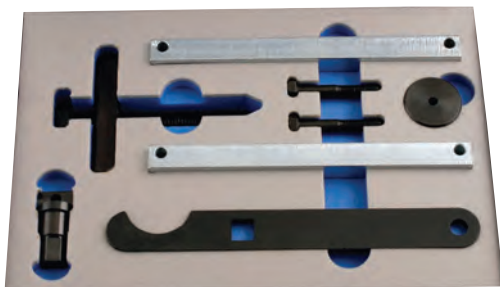

Spare Parts:			
Part No.	OEM Ref.	Description	Image ID
SP230330-02	303-530	Camshaft Locking Bridge (2)	
SP23033-03ABCD	303-588	Crankshaft Pulley Puller Kit	
SP23033-04	303-645 303-531	Crankshaft Locking Pin	
SP23033-01	303-532	Camshaft Sprocket Holding Tool	

**Jaguar 2.2D Diesel Engine Timing Kit
07752800**
D BELT

- Set of locking tools required for cam belt service
- Applications:
Jaguar XF 2.2D ('11-)
- Engine Code:
2.2D - 224DT

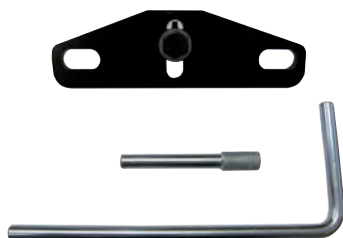

Spare Parts:			
Part No.	OEM Ref.	Description	Image ID
SP23069-25Z	303-1277	Camshaft Pulley Timing Pin	
SP23069-57	303-1270 303-1059	Flywheel Locking Timing Pin	
SP23060-10	303-1272	Flywheel / Ring Gear Locking Tool Adaptor	

**Jaguar 2.7TDV6 Diesel Engine Timing Kit
07754200**
D BELT

- Set of locking tools required for cam belt service
- Applications:
Jaguar S Type ('04-)
Jaguar XF ('08-)
Jaguar XJ6 ('05-)
- Engine Code:
2.7TDV6 - 276DT/7G

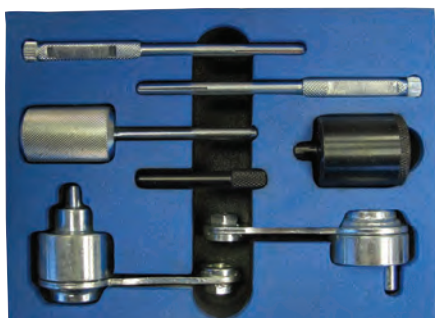

Spare Parts:			
Part No.	OEM Ref.	Description	Image ID
SP23079	303-1132	Camshaft Sprocket Alignment Tool	
SP23061-21Z	303-1126 0195H	Camshaft Sprocket Alignment Pins (2)	
SP23079-03Y	303-1117	Flywheel Locking Tool – Automatic Transmission	
SP23079-02Z	303-1116	Flywheel Locking Tool – Manual Transmission	
SP23061-18X	0195K	Flywheel Locking Tool	
SP23061-19X	0195C	Coolant Pump Pulley Pin	

Jaguar 2.0D / 2.2D Diesel Engine Timing Kit

07753600

D

CHAIN

- Includes timing pins for timing. If both timing and pump removal / installation required - Recommend kit 07752200 (Below)
- Applications:
Jaguar X Type 2.0D / 2.2D ('03-)
- Engine Code:
2.0D - FMBA, FMBB
2.2D - BG, QJBA

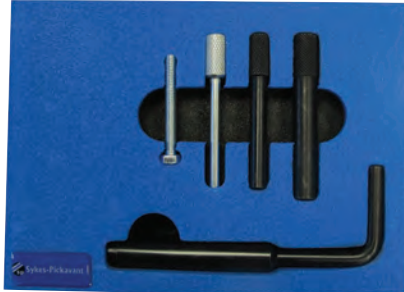

Spare Parts:			
Part No.	OEM Ref.	Description	Image ID
SP23060-11	0194C 21-262 303-734	Flywheel Locking Pin	
SP23060-12	21-234	Flywheel Locking Pin	
SP23060-14	21-251 303-698	Flywheel Locking Pin	
SP23061-08	N/A	HT Setscrew M6 x 45mm	
SP23069-04	0194A 21-260 303-732	Crankshaft / Fuel Pump Alignment Pin	
SP23069-25Z	0194B 21-263 303-735 999-7122	Camshaft Sprocket Locking Pin	

Jaguar 2.0D / 2.2D Diesel Engine Timing Kit

07752200

D

CHAIN

- Set of locking tools enabling correct valve timing and pump removal
- Applications:
Jaguar X Type 2.0D / 2.2D ('03-)
- Engine Code:
2.0D - FMBA, FMBB
2.2D - BG, QJBA



Spare Parts:			
Part No.	OEM Ref.	Description	Image ID
SP23060-02	N/A	Camshaft Sprocket Alignment Pin 6mm	
SP23069-04	0194A 21-260 303-732	Crankshaft / Fuel Pump Alignment Pin 5mm (2)	
SP23060-11	0194C 21-262 303-734	Flywheel Locking Pin 11mm	
SP23069-25Z	0194B 21-263 303-735	Camshaft Sprocket Locking Pin 8mm	
SP23060-12	21-234	Flywheel Locking Pin 14mm	
SP23060-14	21-251 303-698	Flywheel Locking Pin	
SP23175-01	21-238	Fuel Pump Cover Removal Tool	
SP23175-02	303-1151	Locking Tool, Fuel Injection Pump Sprocket	
SP23002-45	310-083A	Key for TX45 Torx Fasteners	
SP23161-06	N/A	Tensioner Pin	

Land Rover Freelander 1.8 Cam Locking Tool 02240000

P BELT

- Set of locking tools required for cam belt service
- Applications: Land Rover Freelander 1.8 ('97-)
- Engine Codes: 1.8 - 18k16, K18
- OEM Reference: 303-936, LRT12-134

Optional Extras:

- SP23111-14 - Flywheel Locking Tool
For use with PG1 Gearbox
- OEM Reference: LRT12-145, 303-947



- SP23111-12 - Flywheel Locking Tool
For use without PG1 Gearbox
- OEM Reference: 18G1571



Land Rover Freelander 2.5 Petrol Engine Timing Kit 07761000

P BELT

- Set of locking tools required for cam belt service
- Applications:
Land Rover Freelander 2.5 ('00-'06)
- Engine Code:
2.5 - KV6

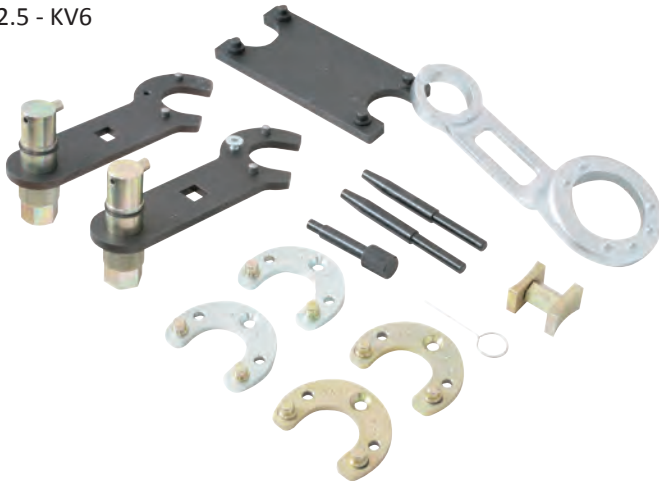

Spare Parts:			
Part No.	OEM Ref.	Description	Image ID
SP23078-01	303-987 LRT 12-196	Camshaft Locking Tool	
SP23078-02	12-187	Camshaft Locking Adaptor - 2.0l	
SP23078-03	12R208	Camshaft Locking Adaptor - 2.5l	
SP23078-04	LRT 12-175 303-973	Rear Camshaft Sprocket Setting Tool	
SP23161-06	N/A	Tensioner Pushrod Retension Pin	
SP23078-06	N/A	Rear Camshaft Sprocket Setting Tool	
SP23078-07	18G 1746A LRT 12-198	Rear Camshaft Sprocket Guide Pin	
SP23078-08	303-1021 LRT 12-232	Crankshaft Locking Pin	
SP23078-09	303-986 LRT 12-195	Rear Cam Sprocket Spreader	

Land Rover 4.2 / 4.4 Petrol Engine Timing Kit 07763000

P CHAIN

- Set of locking tools required for correct valve timing on chain driven engines
- Applications:
Land Rover Discovery 3 ('04-)
Land Rover Range Rover ('05-)
Land Rover Range Rover Sport ('05-)
- Engine Codes:
4.2 - 428PS
4.4 - 448PN

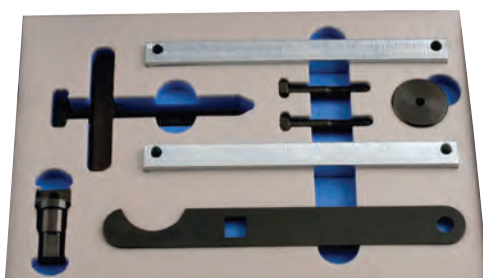

Spare Parts:			
Part No.	OEM Ref.	Description	Image ID
SP230330-02	303-530	Camshaft Locking Bridge (2)	
SP23033-03ABCD	303-588	Crankshaft Pulley Puller Kit	
SP23033-04	303-645 303-531	Crankshaft Locking Pin	
SP23033-01	303-532	Camshaft Sprocket Holding Tool	

Land Rover 2.2 Diesel Engine Timing Kit
07752800

D BELT

- Set of locking tools required for cam belt service
- Applications:
Land Rover Freelander 2 ('06-)
Range Rover Evoque ('11-)
- Engine Code:
2.2TDi - DW12, DW12CTED
2.2D - DW12

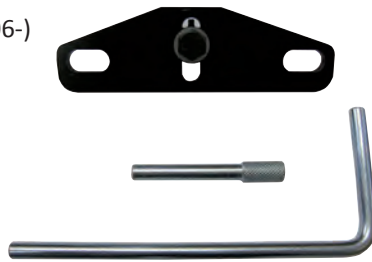

Spare Parts:			
Part No.	OEM Ref.	Description	Image ID
SP23069-25Z	303-1277	Camshaft Pulley Timing Pin	
SP23069-57	303-1270 303-1059	Flywheel Locking Timing Pin	
SP23060-10	303-1272	Flywheel / Ring Gear Locking Tool Adaptor	

Land Rover 2.0D / 3.0D Diesel Engine Timing Kit
07759000

D CHAIN

- Set of locking tools required for correct valve timing on chain driven engines
- Applications:
Land Rover Freelander ('00-'06)
Range Rover ('02-'06)
- Engine Codes:
2.0D - 204D3/TD4
3.0D - TD6

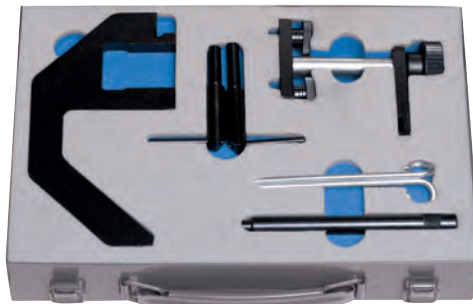

Spare Parts:			
Part No.	OEM Ref.	Description	Image ID
SP23048-01	LRT 12-108 303-912	Crankshaft TDC Setting Pin	
SP23048-09	LRT 12-173 303-971	Camshaft Setting Plate	
SP23048-11	LRT 12-174 303-972	Locking Clamp	
SP23048-12	LRT 12-172 303-970	4.0mm Tensioner Retaining Pin (2)	
SP23048-36	LRT 12-227 303-1016	Flywheel Locking Pin Type 1	
SP23048-37	11 6 080	Flywheel Locking Pin Type 2	

Land Rover 2.5D TD5 Diesel Engine Timing Kit
07766000

D CHAIN

- Set of pins required for correct valve timing on chain driven engines
- Applications:
Land Rover Defender ('99-'07)
Land Rover Discovery II ('98-'04)
- Engine Codes:
2.5D TD5 - 10P, 15P
- OEM Reference: LRT 12-058, LRT 12-158
303-875, 303-960



Land Rover 2.4D TD4 Diesel Engine Timing Kit 07752200

D CHAIN

- Set of locking tools enabling correct valve timing and pump removal
- Applications:
Land Rover Defender ('06-'11)
- Engine Codes:
2.4D TD4 - 244DT



Spare Parts:			
Part No.	OEM Ref.	Description	Image ID
SP23060-02	N/A	Camshaft Sprocket Alignment Pin 6mm	
SP23069-04	0194A 21-260 303-732	Crankshaft / Fuel Pump Alignment Pin 5mm (2)	
SP23060-11	0194C 21-262 303-734	Flywheel Locking Pin 11mm	
SP23069-25Z	0194B 21-263 303-735	Camshaft Sprocket Locking Pin 8mm	
SP23060-12	21-234 / 251	Flywheel Locking Pin 14mm	
SP23060-14	21-251 303-698	Flywheel Locking Pin	
SP23175-01	21-238	Fuel Pump Cover Removal Tool	
SP23175-02	303-1151	Locking Tool, Fuel Injection Pump Sprocket	
SP23002-45C	310-083A	Key for TX45 Torx Fasteners	
SP23161-06	N/A	Tensioner Pin	

Land Rover 2.7TDV6 Diesel Engine Timing Kit 07754200

D BELT

- Set of locking tools required for cam belt service
- Applications:
Land Rover Discovery 3 ('04-)
Land Rover Discovery 4 ('09-)
Land Rover Range Rover Sport ('05-)
- Engine Code:
2.7D TDV6 / 2.7TD - 276DT

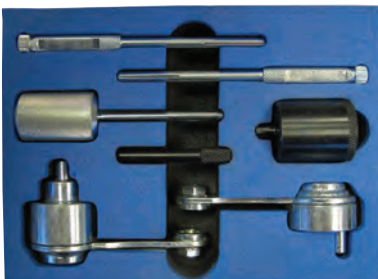

Spare Parts:			
Part No.	OEM Ref.	Description	Image ID
SP23079	303-1132	Camshaft Sprocket Alignment Tool	
SP23061-21Z	303-1126 0195H	Camshaft Sprocket Alignment Pins (2)	
SP23079-03Y	303-1117	Flywheel Locking Tool – Automatic Transmission	
SP23079-02Z	303-1116	Flywheel Locking Tool – Manual Transmission	
SP23061-18X	0195K	Flywheel Locking Tool	
SP23061-19X	0195C	Coolant Pump Pulley Pin	

Mazda 1.25 - 2.5 Petrol Engine Timing Kit
077523V2

P **BELT** **CHAIN**

- Applications:
Mazda 2 ('03-'07)
Mazda 3 ('03-)
Mazda 5 ('05-)
Mazda 6 ('02-)
Mazda 121 ('95-)
Mazda MPV ('02-)
Mazda MX5 ('05-)
Mazda Tribute ('01-)
- Engine Codes:
1.25 (Belt) DHA, FUJA, FUJB, F8JA, F8JB
1.4 (Belt) FXJA, FXJB
1.6 (Belt) FYJA
1.8 (Chain) L8, MRZ (Auto)
2.0 (Belt / Chain) LF, YF, MRZ (Auto)
2.3 (Chain) L3
2.5 (Chain) L5

Spare Parts:			
Part No.	OEM Ref.	Description	Image ID
SP23054-02X	49JE01061	Crankshaft Timing Pin	
SP23054-05	303-748	Crankshaft Timing Pin	
SP23054-03	49N101101	Crankshaft Timing Pin	
SP23054-06	49JE0154	Camshaft Alignment Bar	
SP23161-94	N/A	Tensioner Locking Pin	



Mazda Petrol Engine Timing Kit
07764400

P **CHAIN**

- Applications:
Mazda 3 ('06-)
Mazda 5 ('05-)
Mazda 6 ('10-)
Mazda CX-7 ('07-)
- Engine Codes:
2.0DISI - LF (MZR)
2.3MPS - L3 TURBO

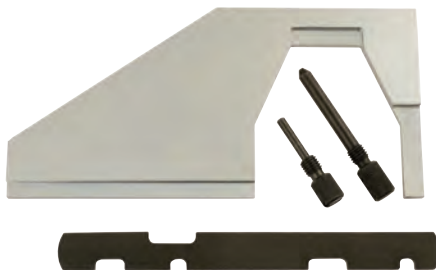

Spare Parts:			
Part No.	OEM Ref.	Description	Image ID
SPE10450	49UN30 310610	Camshaft Locking Plate	
SP23054-06	49JE0154	Camshaft Alignment Bar	
SP23054-03	21 163	Crankshaft Timing Pin	
SP23054-02X	49JE01061	Crankshaft Timing Pin	

Mazda 1.4TDCi / 1.6TDCi Diesel Engine Timing Kit
07763900

D **BELT**

- A set of timing pins required for belt renewal
- Applications:
Mazda 2 ('02-)
Mazda 3 ('03-)
Mazda 5 ('10-)
- Engine Codes:
1.4TDCi - F6JA, F6JB
1.6TDCi - MZ-CD / Y6



Spare Parts:			
Part No.	OEM Ref.	Description	Image ID
SP23060-11	49JE02020	Flywheel Locking Pin	
SP23069-04	49JE02018	Camshaft / Fuel Pump Alignment Tool	
SP23069-25Z	49JE02021	Camshaft Sprocket Locking Tool	

Parts from kit 07752200 (page 175) and 07753600 (page 178)

Mercedes Camshaft, Spanner & Locking Tools for Petrol Engines
07765000
P
CHAIN

- To assist in timing chain work, includes a camshaft spanner and camshaft locking tools
- OEM Reference:
112589000100
112589003200
112589013200
- Applications:
Mercedes C-Class 240/280 (202) ('98-)
Mercedes C-Class 240/320 (203) ('00-)
Mercedes CL 500 (215) ('99-'07)
Mercedes CLK 320/430 (208) ('97-'03)
Mercedes CLK 240/320/500/55AMG (209) ('97-)
Mercedes CLS 500/55AMG (219) ('05-)
Mercedes E-Class 240/280/320/430 (210) ('97-)
Mercedes E-Class 240/320/500/E55AMG (211) ('02-)
Mercedes M-Class ML320/350/430/500/55AMG (163) ('98-)
Mercedes M-Class ML500 (164) ('05-)
Mercedes S-Class 280/320/350/430/500 (220) ('98-)
Mercedes SL 280/320/500 (129) ('98-'02)
Mercedes SL 350/500/55AMG (230) ('02-)
Mercedes SLK 320K (170) ('00-'04)
Mercedes SLK 55AMG (171) ('04-)
Mercedes R-Class 500 ('05-)
Mercedes Viano 3.0/3.2/3.5 ('03-)
Mercedes Vito (639) ('03-)

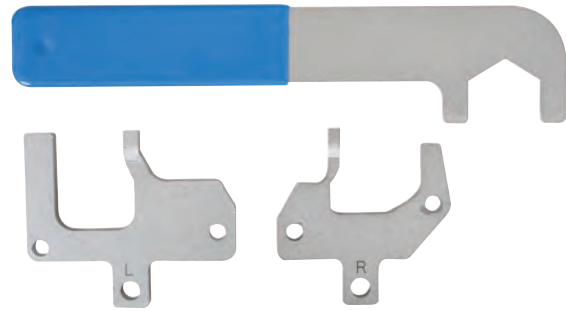

- Engine Codes:
2.4 - 112.910/911
2.6 - 112.912/913/914/915/916/917
2.8 - 112.920/921/922/923
3.2 - 112.940/941/942/943/944/946/947/949/951/
953/954/955
3.7 - 112.970/972/973/975/976
4.3 - 113.940/941/942/943/948
5.0 - 113.960/961/963/964/965/966/967/968/969/971
5.4 - 113.981/987/989/990/992/995

VIBRO IMPACT GLOW PLUG REMOVER SET

FOR THE SAFE, EFFECTIVE REMOVAL OF 8MM, 9MM, 10MM, 11MM & 12MM GLOW PLUGS



SEE PAGE 45

Mercedes Petrol & Diesel Engine Timing Kit
07760000

P **D** **CHAIN**

- Small set of tools to assist engine work on vehicles listed below
- Applications:

- Mercedes C-Class 180/200/220/230/230K/250/280 (202) ('93-'00)
- Mercedes C-Class 180/200/200K/220/230K/270/320 (203) ('00-)
- Mercedes C-Class 180 CGI/200/220/250GHI/320/350 (204) ('07-)
- Mercedes CL 420/500/600 (140) ('95-'99)
- Mercedes CLC 200/220 (203) ('08-)
- Mercedes CLK 200/200K/230K (208) ('96-'03)
- Mercedes CLK 220/270/320 (209) ('02-)
- Mercedes CLS 320/350 (219) ('05-)
- Mercedes E-Class 200/250 CGI (207) ('09-)
- Mercedes E-Class 200/200K/220/230/250/270/280/290/300 (210) ('95-)
- Mercedes E-Class 200/220/270/280/300/320/400/420 (211) ('02-)
- Mercedes E-Class 200/250 CGI (212) ('09-)
- Mercedes GL 320/350/420/450 (164) ('06-)
- Mercedes GLK 320/350 (204) ('08-)
- Mercedes M-Class ML 230/270/400 (163) ('98-'05)
- Mercedes M-Class ML 280/300/320/350 (164) ('05-)
- Mercedes S-Class 280/300/320/350/400/420/500/600 (140) ('93-'99)
- Mercedes S-Class 320/400 (220) ('99-)
- Mercedes S-Class 320/350/420 (221) ('05-)
- Mercedes SL 280/320/500/600 (129) ('93-'00)
- Mercedes SLK 200/200/230K (170) ('96-'04)
- Mercedes Sprinter ('99-'10)
- Mercedes V-Class ('96-'03)
- Mercedes Viano ('03-)
- Mercedes Vario ('02-)
- Mercedes Vito ('99-)

- Engine Codes:

- 1.8 - 111.920/921, 271.820/860
- 2.0 - 111.941 /942/943/944/945/946/947/948/950/951/952/955/956/957/958
- 2.0 - 601.913/915, 604.917
- 2.1CDI - 646.811/812/820/821/951/961/962/963/966/980/981/982/983/984/986/989/990
- 2.2 - 111.961
- 2.2D - 604.910/912
- 2.2CDI - 611.960/961/962/980/981/987
- 2.3 - 601.942/943/970, 111.970/973/974/975/977/978/979/980/981/982/983/984
- 2.5D - 605.910/912/960/962
- 2.7CDI - 612.961/962/963/967/981, 647.961
- 2.8 - 104.941/943/944/945
- 2.8CDI - 642.990
- 2.9D - 602.980/982/984/985
- 3.0D - 606.912/961/962
- 3.0CDI - 642.820/830/832/910/920/921/922/930/932/940/960/961/990
- 3.2 - 111.946, 104.943/994/995
- 3.2CDI - 613.960/961, 648.960/961
- 3.5D - 603.971
- 3.9CDI - 628.960/961/962/963
- 4.0CDI - 629.910/911/912
- 4.2 - 119.971/981/985
- 5.0 - 119.970/972/980/982
- 6.0 - 120.980/981/982/983

Spare Parts:			
Part No.	OEM Ref.	Description	Image ID
SP23241-01	601589024000	Flywheel Plate Locking Tool c/w Bolts M6 x 90mm (2)	
SP23241-02	602589004000	Flywheel Plate Locking Tool	
SP23241-03	111589031500	Camshaft Locking Pin Set (2)	



Mini 1.6 Petrol Engine Timing Kit 07758300

P CHAIN

- Enables the correct valve timing to be made when servicing the engine
- Applications:
Mini One (R50/52/53) ('01-'09)

- Engine Codes:
1.6 - W10B16AA,
W10B16BA,
W11B16AA

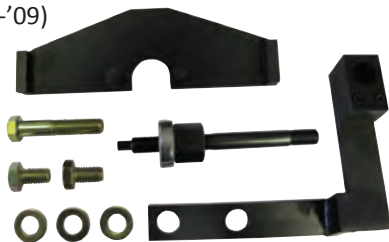
Spare Parts:

Part No.	OEM Ref.	Description	Image ID
SP23180-01	118 250	Camshaft Sprocket Holding Tool	
SP23180-02	118 370	Engine Support Bracket	
SP23180-03	118 240	Tensioner Assembly Tool	

Mini 1.4 / 1.6 VTI Petrol Engine Timing Kit 07759400

P CHAIN

- Enables the correct valve timing to be made on M12 valvetronic engines
- Applications:
Mini 1.4, 1.6 (R56/57) ('07-)
Mini One (R56/57) ('07-)
Mini One/First (R56/57) ('10-)
Mini Cooper (R56/57) ('06-)
Mini Cooper Coupe (R58) ('11-)
Mini Clubman One / Clubman Cooper (R55) 07-
Mini Countryman Cooper / One (R60) ('10-)
Mini Roadster Coupe (R59) ('12-)

- Engine Codes:
1.4 VTI - N12B14/AB
1.6 VTI - N12B16A,
N16 B16A,
N16 B16KO,
N16 B16MO,
N16B16UO

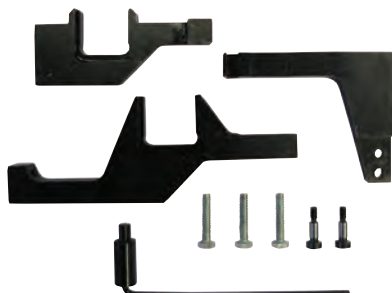
Spare Parts:

Part No.	OEM Ref.	Description	Image ID
SP23048-26	119 540	Inlet Camshaft Locking Tool (2 parts)	
SP23048-27	119 540	Camshaft Locking Tool - Exhaust	
SP23048-24	119 590	Crankshaft Setting Pin	
SPSSM6X30	Screws	M6 Setscrews (3)	

Optional Extras:

- SP23048-14 (119-340) - Timing Chain Pre-Tensioning Tool
See page 228 for further details

Parts from kit 07758600 (see page 186)

Mini 1.6 Petrol Engine Timing Kit 07759500

P CHAIN

- Enables the correct valve timing to be made on M14 direct injection engines
- Applications:
Mini Cooper S (R56/57) ('06-)
Mini JWC (R56/57) ('08-)
Mini Clubman Cooper S (R55) ('07-)
Mini Clubman JCW (R55) ('08-)

- Engine Codes:
1.6 - N14 B16A,
N14 B16CD

Spare Parts:

Part No.	OEM Ref.	Description	Image ID
SP23048-21	119 550	Camshaft Locking Tool - Inlet	
SP23048-27	119 551	Camshaft Locking Tool - Exhaust	
SP23048-23	119 552	Camshaft Alignment Clamp	
SP23048-24	119 590	Crankshaft Setting Pin	
SPSSM6X30	Screws	M6 Setscrews (3)	

Optional Extras:

- SP23048-14 (119-340) - Timing Chain Pre-Tensioning Tool
See page 228 for further details

Parts from kit 07758600 (see page 186)

Mini 1.4 / 1.6 Petrol Engine Timing Kit 07758600

P

CHAIN

- Set of locking tools required for correct valve timing on chain driven engines
- Applications:
 - Mini Cooper S (R56/57) ('06-)
 - Mini JWC (R56/57) ('08-)
 - Mini Clubman Cooper S (R55) ('07-)
 - Mini Clubman JCW (R55) ('08-)
 - Mini 1.4, 1.6 (R56/57) ('07-)
 - Mini One (R56/57) ('07-)
 - Mini One/First (R56/57) ('10-)
 - Mini Cooper (R56/57) ('06-)
 - Mini Cooper Coupe (R58) ('11-)
 - Mini Clubman One / Clubman Cooper (R55) 07-
 - Mini Countryman Cooper / One (R60) ('10-)
 - Mini Roadster Coupe (R59) ('12-)
- Engine Codes:
 - 1.4 - N12B14/AB
 - 1.6 - N14 B16A, N14 B16CD
 - 1.6 - N12B16A, N16 B16A, N16 B16KO, N16 B16MO, N16B16UO

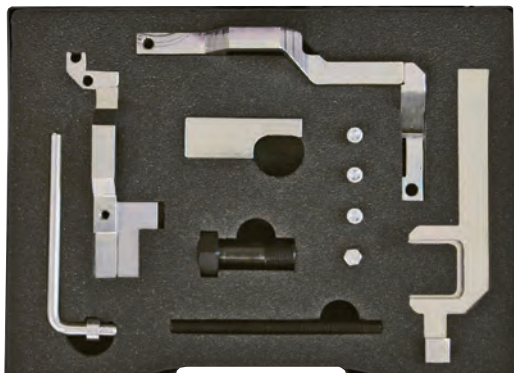

Spare Parts:

Part No.	OEM Ref.	Description	Image ID
SPSSM6X30	Screws	M6 Setscrews (3)	○○○
SP23048-14	119 340	Timing Chain Pre-Tensioning Tool	
SP23048-24	119 590	Crankshaft Setting Pin	
SP23048-23	119 552	Camshaft Alignment Clamp	
SP23048-26	119 540	Inlet Camshaft Locking Tool (2 parts)	
SP23048-21	119 550	Camshaft Locking Tool - Inlet	
SP23048-27	119 540	Camshaft Locking Tool - Exhaust	

Mini 1.6 Diesel Engine Timing Kit 07759300

D

BELT

- Applications:
 - Mini Cooper D (R56/R57) ('07-)
 - Mini One D (R56/57) ('09-)
 - Mini Clubman Cooper D (R55) ('07-)
- Engine Codes:
 - 1.6D - W16 D16 (9HZ), W16 D16 UO



Spare Parts:

Part No.	OEM Ref.	Description	Image ID
SP23069-04	119 790	Crankshaft Timing Pin	
SP23069-25Z	110 300	Camshaft / High Pressure Fuel Pump Timing Pin (2)	
SPE10133	119 851/2	Flywheel Holding Tool	

Mini 1.6 / 2.0 Diesel Engine Timing Kit

07758900





D CHAIN

• Applications:

- Mini Cooper D (R56/R57) ('10-)
- Mini One D (R56/57) ('10-)
- Mini Cooper D (R56/R57) ('11-)
- Mini Cooper SD (R56/R57) ('11-)
- Mini Coupe Cooper SD (R58) ('11-)
- Mini Roadster Cooper SD (R59) ('12-)
- Mini Clubman Cooper D (R55) ('10-)
- Mini Clubman One D (R55) ('10-)
- Mini Clubman Cooper SD (R55) ('10-)
- Mini Countryman One D (R60) ('11-)
- Mini Countryman Cooper D (R60) ('11-)
- Mini Countryman Cooper SD (R60) ('11-)

• Engine Codes:

- 1.6D - N47 C16K1, N47 C16U1
- 2.0D - N47 C20K1, N47 C20U1

Spare Parts:			
Part No.	OEM Ref.	Description	Image ID
SP23048-37	115 320	Flywheel Plate Timing Pin	
SP23048-35Z	118 760	Camshaft Alignment Tool	
SP23048-45	116 480	Crankshaft Pulley Turning Tool	
SP23048-46	118 740	High Pressure Pump Sprocket Removal Tool	
SP23048-11Z	113 340	Tensioner Locking Pins (2)	



**FOR THE LATEST
PRODUCT INFORMATION
VISIT OUR NEW WEBSITE:
www.sykes-pickavant.com**

Nissan 1.6 / 2.0 Petrol Engine Timing Kit
07755100

P BELT

- Applications:
Nissan Kubistar
Nissan Primastar
- Engine Codes:
1.6 - K4M 752/753
2.0 - F4R720/722/800



Spare Parts:			
Part No.	OEM Ref.	Description	Image ID
SP23054-04	MOT 1489	Crankshaft Timing Pin	
SP23069-23	MOT 1054	Timing Pin	
SP23069-52	MOT 1496	Camshaft Setting Tool	

Nissan 1.2 / 1.5 Petrol & Diesel Engine Timing Kit
07755700

P D BELT

- Applications:
Nissan Almera (N16) ('02-)
Nissan Evalia / Qube / NV200 ('09-)
Nissan Juke ('10-)
Nissan Kubistar ('03-)
Nissan Micra (K12) ('03-)
Nissan Note ('06-)
Nissan Qashqai ('07-)
Nissan Tiida ('07-)
- Engine Codes:
1.2 - D7F 726
1.2 16V - D4F 712
1.5DCI - K9K/K9K 702/704/710/714/716/718



Spare Parts:			
Part No.	OEM Ref.	Description	Image ID
SP23054-04	MOT 1489	Crankshaft Timing Pin	
SP23069-23	MOT 1054	Timing Pin	
SP23069-25Z	MOT 1430	Crankshaft Timing Pin	

Nissan 1.9 / 2.2 / 2.5 Diesel Engine Timing Kit
07755200

D BELT

- Applications:
Nissan Interstar ('02-)
Nissan Primera (P12) ('03-)
Nissan Primastar ('02-)
- Engine Codes:
1.9D DCI - F9Q/F9Q 760/762/772/774
2.2D DCI - G9T 722/750
2.5D DCI - G9U 630/632/650/720/724/726/730/750/754



Spare Parts:			
Part No.	OEM Ref.	Description	Image ID
SP23164-18	MOT 1536 KM-6203	Flywheel Setting Pin	
SP23164-19	MOT 1537 KM-6204	Camshaft Locking Tool - Exhaust	
SP23164-19E	N/A	Locking Screw M8 x 60 mm (2)	
SP23164-20	MOT 1534 KM-6205	Camshaft Locking Tool - Inlet	
SP23164-17	MOT 1538	Hi-Pressure Fuel Pump Pulley Locking Pin	
SP23054-04	MOT 1489	Crankshaft Timing Pin	
SP23061-08	N/A	Tensioning Screw M6 x 45 mm	
SP23069-23	MOT 1054	Flywheel Locking Pin	
SP23069-25Z	MOT 1430	Camshaft Timing Pin	
SP23069-59	MOT 1543	Tension Pre-setting Tool	

Nissan 2.0DCI Diesel Engine Timing Kit
07755500
D CHAIN

- Applications:
Nissan Primastar ('08-)
Nissan Qashqai ('07-)
Nissan X-Trail (T31) ('07-)
- Engine Codes:
2.0DCI - M9R/M9R780/782/784

Spare Parts:

Part No.	OEM Ref.	Description	Image ID
SP23069-04Z	N/A	Tensioner Locking Pin 2.9mm	
SP23069-75Z	MOT 1770 EN-48334	Crankshaft Pulley Holding Tool	
SP23069-76	MOT 1769 EN-48332	Camshaft Setting Tool	
SP23069-77	MOT 1773 EN-48331	Camshaft Gear Alignment Tool	
SP23069-78Z	PIN 3.6MM KM-6130	Auxiliary Belt Tensioner Locking Pin	
SP23069-79X	MOT 1766 EN-48330	Crankshaft Locking Pin (2.0 DCI)	

Nissan 2.2 / 2.5 Diesel Pump Locking Tool
07764900
D CHAIN

- Applications:
Nissan Almera (N16) ('00-)
Nissan Almera Tino ('03-)
Nissan Cabstar ('06-)
Nissan Pathfinder ('04-)
Nissan Navara Pick Up ('02-)
Nissan Primera (P12) ('02-)
Nissan X-Trail (T30) ('01-)
- Engine Codes:
2.2D/DI/DCI - YD22D DCI, YD22DDT, YD22DDTI
2.5D/DCI - YD25DDTI
- OEM Reference: KV1106030



SEAL REMOVAL & REPLACEMENT KIT

REMOVE & INSTALL AWKWARD SEALS AS FOUND ON ENGINES, GEAR BOXES & POWER STEERING PUMPS

SEE PAGE 47



Opel / Vauxhall 1.0 / 1.2 / 1.4 Petrol Engine Timing Kit
07753200

P CHAIN

- Applications:
Opel / Vauxhall Agila ('00-)
Opel / Vauxhall Astra-G ('00-)
Opel / Vauxhall Astra-H / TwinPort ('04-)
Opel / Vauxhall Combo ('03-)
Opel / Vauxhall Corsa B ('97-)
Opel / Vauxhall Corsa C / TwinPort ('00-)
Opel / Vauxhall Corsa D ('06-)
Opel / Vauxhall Meriva ('04-)
Opel / Vauxhall Tigra B ('04-)

- Engine Codes:
1.0 - X10XE 12v, Z10XE 12v, Z10XEP
1.2 - X12XE 12v, Z12XE 16v, Z12XEP 16v
1.4 - Z14XEP, Z14XEL



Spare Parts:			
Part No.	OEM Ref.	Description	Image ID
SP23164-11	KM-952	Crankshaft TDC Timing Pin	
SP23164-12	KM-953	Camshaft Setting Plate	
SP23164-14	KM-954	Timing Disc Position Gauge	
SP23164-15	KM-955	Tensioner Retaining Pin - 2.5mm	
SP23164-16	KM-955	Tensioner Retaining Pin - 4.0mm	

Opel / Vauxhall 1.0 / 1.2 / 1.4 Petrol Engine Timing Kit
07763500

P CHAIN

- Applications:
Opel / Vauxhall Adam ('12-)
Opel / Vauxhall Ampera ('11-)
Opel / Vauxhall Astra J ('09-)
Opel / Vauxhall Corsa D ('09-)
Opel / Vauxhall Insignia ('11-)
Opel / Vauxhall Meriva-B ('10-)
Opel / Vauxhall Mokka ('10-)
Opel / Vauxhall Zafira C ('11-)

- Engine Codes:
1.0 - A10XEP
1.2 16V - A12XEL (LWD), A12XER
1.4 16v - A14NEL (LUJ), A14NET (LUJ), A14XEL (LDD), A14XER (LDD)



Spare Parts:			
Part No.	OEM Ref.	Description	Image ID
SP23164-11EX	KM-953-A	Camshaft Locking Tool	
SPE10562	EN-49977-100	Camshaft Position Sensor Disc Setting Tool	
SP23164-12	KM-952	Crankshaft Locking Pin	
SPE10656	EN-49978	Camshaft Sensor Locking Tool	
SPE10329	EN-49977-200	Inlet Camshaft Adjuster Locking Tool	
SP23164-15Z	KM-955-1	Chain Tensioner Locking Pin	
SP23164-16Y	KM-955-2	Belt Tensioner Locking Pin	

Opel / Vauxhall 1.4 / 1.6 / 1.8 Petrol Engine Timing Kit
07764600
P BELT
Applications:

- Opel / Vauxhall Astra-G ('98-)
- Opel / Vauxhall Astra H ('04-)
- Opel / Vauxhall Combo ('01-)
- Opel / Vauxhall Corsa-B ('94-)
- Opel / Vauxhall Corsa-C ('00-)
- Opel / Vauxhall Meriva ('03-)
- Opel / Vauxhall Signum ('03-)
- Opel / Vauxhall Tigra ('94-)
- Opel / Vauxhall Tigra B ('04-)
- Opel / Vauxhall Vectra-B ('96-)
- Opel / Vauxhall Vectra-C ('02-)
- Opel / Vauxhall Zafira ('99-)

Also suitable for Saab 9-3 ('03-)

Engine Codes:

- 1.4 16v - X14XE, Z14XE
- 1.8 - X18XE1, Z18XE, Z18XEL

1.6 8/16v - X16SZR, X16XEJ, X16XEL, Y16XE, Z16SE, Z16XE, Z16YNG

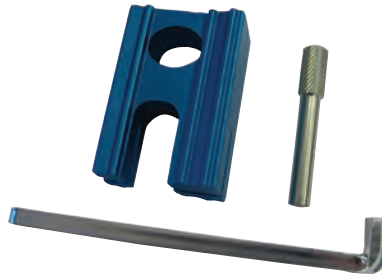
Spare Parts:

Part No.	OEM Ref.	Description	Image ID
SP23058-01	KM-852	Camshaft Locking Tool	
SP23164-04Z	KM-911	Flywheel Locking Tool	
SP23174-01Z	KM-6130	Locking Pin	

Opel / Vauxhall 1.8 / 2.0 / 2.2 Petrol Engine Timing Kit
02290000
P BELT
Applications:

- Opel / Vauxhall Astra-G ('98-'03)
- Opel / Vauxhall Astra H ('04-'09)
- Opel / Vauxhall Frontera-A ('92-'98)
- Opel / Vauxhall Frontera-B ('99-'04)
- Opel / Vauxhall Omega-B ('94-'03)
- Opel / Vauxhall Sintra ('96-'99)
- Opel / Vauxhall Speedster ('03-)
- Opel / Vauxhall Vectra-B ('95-'02)
- Opel / Vauxhall Zafira ('99-'04)
- Opel / Vauxhall Zafira B ('05-'10)

Engine Codes:

- 1.8 - X18XE
- 2.0 16v - C20SEL, X20XEV, Z20LEH, Z20LEL, Z20LER, Z20LET
- 2.2 16v - X22SE, X22XE, Y22SE, Y22XE, Z22XE

OEM Reference: KM-853

Opel / Vauxhall 1.6 & 1.8 16v Twinport Petrol Engine Timing Kit
07753900
P BELT
Set of locking tools required for cam belt service & replacement
Applications:

- Opel / Vauxhall Astra-G ('03-'06)
- Opel / Vauxhall Astra-H ('04-'09)
- Opel / Vauxhall Astra-J ('09-)
- Opel / Vauxhall Corsa-D ('07-)
- Opel / Vauxhall Insignia ('08-)
- Opel / Vauxhall Meriva ('06-'09)
- Opel / Vauxhall Mokka ('12-)
- Opel / Vauxhall Signum ('06-)
- Opel / Vauxhall Vectra-C ('06-)
- Opel / Vauxhall Zafira B ('03-'09)

Engine Codes:

- 1.6 16v - A16LEL, A16LER, A16LET, A16XER, A16XNT, Z16XE1, Z16XEP, Z16XER, Z16LEL, Z16LET, Z16LER, Z16XNT
- 1.8 16v - A18XER, Z18XER

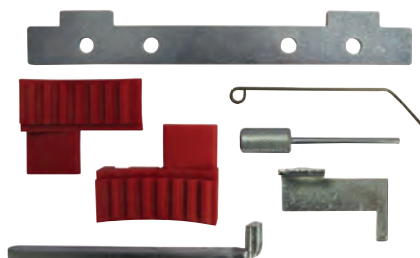
Spare Parts:

Part No.	OEM Ref.	Description	Image ID
SPE10290	KM-6628-A	Camshaft Locking Bar	
SP23056-06	KM-6340	Camshaft Pulley Locking Tool (2)	
SP23056-05	KM-6333	Tensioner Locking Pin	
SPE10230	KM-6625	Fly Wheel Holding Tool	
SP23174-01	KM-6349 KM-6130	Locking Pin	
SP23164-04	KM-911	Flywheel Holding Tool	

Opel / Vauxhall 2.2 16v Twin Cam Petrol Engine Timing Kit
07753700

P CHAIN

- Applications:
Opel / Vauxhall Astra-G ('00-'06)
Opel / Vauxhall Astra-H ('06-'09)
Opel / Vauxhall Signum ('03-'08)
Opel / Vauxhall Speedster (VX220) ('00-'06)
Opel / Vauxhall Vectra-B ('00-'04)
Opel / Vauxhall Vectra-C ('04-'08)
Opel / Vauxhall Zafira ('00-'05)
Opel / Vauxhall Zafira-B ('05-)

- Engine Codes:
2.2 16v - Z22SE, Z22YH



Spare Parts:			
Part No.	OEM Ref.	Description	Image ID
SP23164-22	KM-6148	Camshaft Timing Tool	
SP23164-23	KM-6077	Tensioner Pin	

Opel / Vauxhall 2.5, 2.6, 3.0, 3.2 V6 Petrol Engine Timing Kit
07753500

P BELT

- Applications:
Opel / Vauxhall Antara ('06-)
Opel / Vauxhall Omega-B ('94-'03)
Opel / Vauxhall Signum ('03-'05)
Opel / Vauxhall Sintra ('96-'99)
Opel / Vauxhall Vectra-A ('93-'95)
Opel / Vauxhall Vectra-B ('96-'02)
Opel / Vauxhall Vectra-C ('02-'05)

- Engine Codes:
2.5 V6 - C25XE, X25XE
2.6 V6 - Y26SE
3.0 V6 - X30XE
3.2 V6 - Y32SE, Z32SE



Spare Parts:			
Part No.	OEM Ref.	Description	Image ID
SP23047-01	KM-800-10	Camshaft Locking Tool	
SP23047-02	KM-800-20	Crankshaft Timing Gauge	
SP23047-03	KM-800-2	Camshaft Locking Tool (LH) Green	
SP23047-04	KM-800-1	Camshaft Locking Tool (RH) Red	
SP23047-05	KM-800-30	Belt Holding Wedge	

Opel / Vauxhall 2.0 Petrol Engine Timing Kit
07755100

P BELT

- Applications:
Opel / Vauxhall Vivaro ('01-)

- Engine Codes:
2.0 - F4R720, F4R722,
F4R820



Spare Parts:			
Part No.	OEM Ref.	Description	Image ID
SP23054-04	MOT 1489	Crankshaft Timing Pin	
SP23069-23	MOT 1054 KM-6031	Timing Pin	
SP23069-52	MOT 1496 KM-6233	Camshaft Setting Tool	

Opel / Vauxhall 2.0 / 2.3D CDTI Diesel Engine Timing Kit
07755500
D CHAIN

- Applications:
Opel / Vauxhall Movano B ('10-)
Opel / Vauxhall Vivaro ('06-)
- Engine Codes:
2.0D CDTI - M9R 780, M9R 630, M9R 782, M9R 784, M9R 786, M9R 788
2.3D CDTI - M9T 670, M9T 672, M9T 676, M9T 678, M9T 680, M9T 690, M9T 692, M9T 694, M9T 696, M9T 698



Spare Parts:			
Part No.	OEM Ref.	Description	Image ID
SP23069-04Z	N/A	Tensioner Locking Pin 2.9mm	
SP23069-75Z	MOT 1770 EN-48334	Crankshaft Pulley Holding Tool	
SP23069-76	MOT 1769 EN-48332	Camshaft Setting Tool	
SP23069-77	MOT 1773 EN-48331	Camshaft Gear Alignment Tool	
SP23069-78Z	PIN 3.6MM KM-6130	Auxiliary Belt Tensioner Locking Pin	
SP23069-79X	MOT 1766 EN-48330	Crankshaft Locking Pin (2.0 DCi)	

Opel / Vauxhall 1.3D CDTI Diesel Engine Timing Kit
07751800
D CHAIN

- Set of locking tools required for chain service and engine rebuilds
- Applications:
Opel / Vauxhall Agila ('03-'08) Opel / Vauxhall Corsa-D ('06-)
Opel / Vauxhall Agila B ('08-) Opel / Vauxhall Meriva ('04-)
Opel / Vauxhall Astra H ('05-'09) Opel / Vauxhall Meriva B ('10-)
Opel / Vauxhall Astra J ('09-) Opel / Vauxhall Tigra B ('04-)
Opel / Vauxhall Combo ('03-) Opel / Vauxhall Zafira B ('06-)
Opel / Vauxhall Corsa-C ('03-)
- Engine Codes:
1.3D CDTI - A13DTC, A13DTE, A13DTR, D13A, Z13DT, Z13DTE, Z13DTH, Z13DTJ, Z13DTR

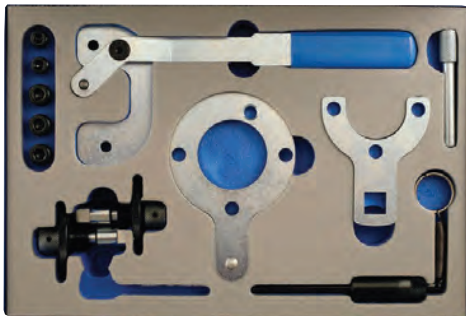

Spare Parts:			
Part No.	OEM Ref.	Description	Image ID
SP23223	1.871.000.200	Crankshaft Pulley Flange Holding Wrench	
SP23222	1.870.900.400 KM-6347	Timing Chain Tensioner Lever	
SP23171-02	1.871.000.900 EN-46781	Camshaft Alignment Tool (2)	
SP23174-02	EN-46785	Flywheel Pin with Spring	
SP23069-25Z	KM-613	8mm Crank Locking Pin	
SP23221	1.870.900.300	Crankshaft Timing Position Tool	

Opel / Vauxhall 1.3D CDTI Diesel Engine Timing Kit
07761900
D CHAIN

- Set of locking tools required for chain service
- Small basic set comprising of components from above kit



Opel / Vauxhall 1.9DCDTI & 2.0DCDTI Diesel Engine Timing Kit

07764700

D BELT

- Set of locking tools required for cam belt service
- Applications:
 - Opel / Vauxhall Astra H ('04-)
 - Opel / Vauxhall Astra J ('09-)
 - Opel / Vauxhall Insignia ('08-)
 - Opel / Vauxhall Signum ('04-)
 - Opel / Vauxhall Vectra-C ('04-)
 - Opel / Vauxhall Zafira B ('05-)

- Engine Codes:
 - 1.9DCDTI - Z19DT, Z19DTH, Z19DTJ, Z19DTL
 - 2.0DCDTI - A20DT, A20DTC, A20DTH, A20DTJ, A20DTL



Spare Parts:			
Part No.	OEM Ref.	Description	Image ID
SP23111-06Z	1.860.898.000	Flywheel Holding Tool	
SP23174-04X	1.870.896.900 EN-46789	Camshaft Alignment Pins (2)	
SP23111-08	1.860.905.000 1.860.905.010 2.000.004.500 2.000.003.000 EN-46788	Crankshaft Alignment Tool	
SP23069-07X	1.860.965.000 KM-6349	Crankshaft Alignment Pin	
SP23174-05	EN-46789-100	Camshaft Alignment Screw	

Opel / Vauxhall 2.0D Diesel Engine Timing Kit

07753800

D BELT

- Set of locking tools required for cam belt service
- Applications:
 - Opel / Vauxhall Antara 2.0D ('06-)

- Engine Codes:
 - 2.0D - Z20DMH, Z20DM

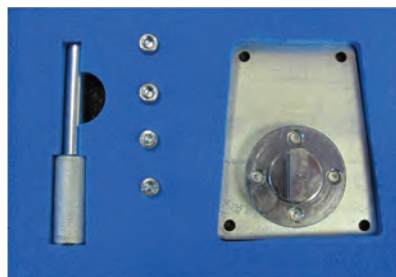

Spare Parts:			
Part No.	OEM Ref.	Description	Image ID
SP23036-02	EN-48245	Camshaft Locking Tool	
SP23036-01	EN-48246	Crankshaft Locking Pin	

Opel / Vauxhall 2.0D / 2.2D Diesel Engine Timing Kit

07753300

D CHAIN

- Set of locking tools required for chain maintenance
- Applications:
 - Opel / Vauxhall Astra-G ('98-'05)
 - Opel / Vauxhall Frontera-B ('98-'04)
 - Opel / Vauxhall Omega-B ('97-)
 - Opel / Vauxhall Signum ('03-)
 - Opel / Vauxhall Sintra ('97-'99)
 - Opel / Vauxhall Vectra-B ('96-)
 - Opel / Vauxhall Vectra-C ('02-'05)
 - Opel / Vauxhall Zafira ('99-)

- Engine Codes:
 - 2.0D - X20DTH, X20DTL, Y20DTH, Y20DTL
 - 2.2D - X22DTH, Y22DTH, Y22DTR



Spare Parts:			
Part No.	OEM Ref.	Description	Image ID
SP23164-05	KM-933	Timing Adjustment Wrench	
SP23164-06	KM-933	Timing Adjustment Bracket Assembly	
SP23164-07	KM-927	Injection Pump Setting Pin	
SP23164-08	KM-929	Flywheel Locking Pin	
SP23164-09	KM-932	Camshaft Timing Tool	

**Opel / Vauxhall 1.9 / 2.2 / 2.5 CDTI / DTI Timing Kit
07755200**
D BELT

- Set of locking tools required for cam belt service
- Applications:
Opel / Vauxhall Movano ('00-)
Opel / Vauxhall Vivaro ('01-)
- Engine Codes:
1.9DI/DTI/CDTI - F9Q760/762/772/774
2.2D DTI - G9T720/722/750
2.5D DTI CDTI - G9U630/632/650/A720/724/726/730/750/754



Spare Parts:			
Part No.	OEM Ref.	Description	Image ID
SP23164-18	MOT 1536 KM-6203	Flywheel Setting Pin	
SP23164-19	MOT 1537 KM-6204	Camshaft Locking Tool - Exhaust	
SP23164-19E	N/A	Locking Screw M8 x 60 mm (2)	
SP23164-20	MOT 1534 KM-6205	Camshaft Locking Tool - Inlet	
SP23164-17	MOT 1538	Hi-Pressure Fuel Pump Pulley Locking Pin	
SP23054-04	MOT 1489	Crankshaft Timing Pin	
SP23061-08	N/A	Tensioning Screw M6 x 45 mm	
SP23069-23	MOT 1054	Flywheel Locking Pin	
SP23069-25Z	MOT 1430	Camshaft Timing Pin	
SP23069-59	KM-6234	Tension Pre-setting Tool	

**Opel / Vauxhall 2.5 / 2.8 Diesel Engine Timing Kit
07751500**
D BELT

- Set of locking tools required for cam belt service
- Applications:
Opel / Vauxhall Movano ('98-'01)
Opel / Vauxhall Movano ('98-'03)
- Engine Codes:
2.5D - SU8 770, SU8 772
2.8DT - S9W 700, S9W 702



Spare Parts:			
Part No.	OEM Ref.	Description	Image ID
SP23101	1.860.638.000	Tensioning Tool	
SP23069-23	MOT 1054	Camshaft Locking Pin	
SP23069-22	MOT 910	TDC Timing Pin (2)	

Peugeot 1.4 16v Petrol Engine Timing Kit (TU3A/JP)

07754500

P BELT

- Set of locking tools required for cam belt service
- Applications:
 - Peugeot 106 ('00-'03)
 - Peugeot 206/206CC ('00-)
 - Peugeot 207 ('06-)
 - Peugeot 307 ('01-)
 - Peugeot 1007 ('05-'09)
 - Peugeot Partner ('00-)
 - Peugeot Bipper ('07-)
- Engine Codes:
 - 1.4 - KFU, KFV, KFW

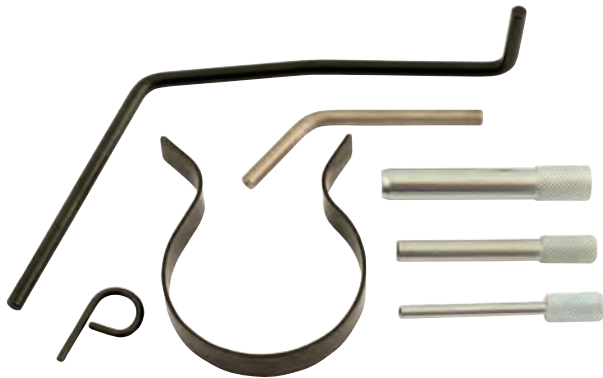

Spare Parts:			
Part No.	OEM Ref.	Description	Image ID
SPE10232	4507-TA 0132-QY	Flywheel Timing Pin - 6mm dia long	
SP23069-53	4533-TAD 0132-AK 0188-K 0189-K 0153-AK	Timing Belt Clip	
SP23069-33X	0153-AL 4200-TA	3mm Tensioner Pin	
SP23069-04	0178-D 0194-A 0132-AB 4527-TS2 5711-TD	Camshaft Locking Pin (Inlet 16v) 5mm dia	
SP23069-25Z	4533-TAC1 0132-AJ1 0187-B 0189-B 0188-M 0194-B	Camshaft Locking Pin (Exhaust 16v) 8mm dia	
SP23055-02X	0132-RZ 4507-TB	Camshaft Locking Pin (8 Valve Engine) 10mm dia	
SP23055-01X	4507-TA 0132-QY	Flywheel Locking Pin - 6mm dia short	

Peugeot 1.4VTI / 1.6VTI Petrol Engine Timing Kit

07759400

P CHAIN

- Set of locking tools required for correct valve timing on chain driven engines
- Applications:
 - Peugeot 207/CC ('07-)
 - Peugeot 208 ('12-)
 - Peugeot 308/CC ('07-)
 - Peugeot 508 ('11-)
 - Peugeot 3008 ('09-)
 - Peugeot 5008 ('09-)
 - Peugeot Partner ('09-)
- Engine Codes:
 - 1.4VTI - EP3/C 8FP, 8FR, 8FS, 8FN
 - 1.6VTI - EP6/C 5FK, 5FS, 5FW, 5FH

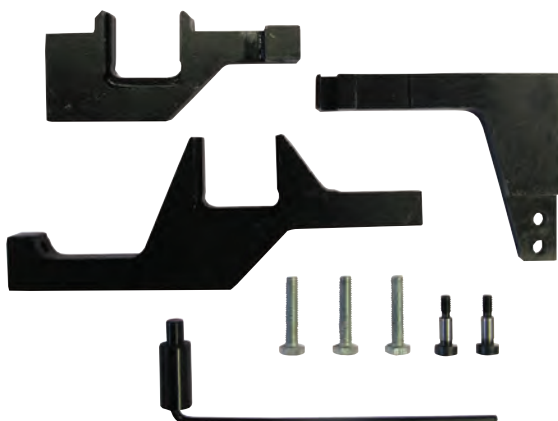

Spare Parts:			
Part No.	OEM Ref.	Description	Image ID
SP23048-26	0197-A3	Inlet Camshaft Locking Tool (2 parts)	
SP23048-27	0197-A1	Camshaft Locking Tool - Exhaust	
SP23048-24	0197-B	Crankshaft Setting Pin	
SPSSM6X30	Screws	M6 Setscrews (3)	

Optional Extras:

- SP23048-14 (119 340) - Timing Chain Pre-Tensioning Tool
See page 228 for further details

**Peugeot 1.6 Petrol Engine Timing Kit
07759500**
P CHAIN

- Set of locking tools required for correct valve timing on chain driven engines
- Applications:
Peugeot 207/CC ('07-)
Peugeot 308/CC ('07-)
Peugeot 508 ('11-)
Peugeot 3008 ('09-)
Peugeot 5008 ('09-)
Peugeot RCZ ('10-)
- Engine Codes:
1.6 - GT/THP EP6CDTE/X/DT 5FN, 5FR, 5FT, 5FU, 5FV, 5FX, 5FY



Spare Parts:			
Part No.	OEM Ref.	Description	Image ID
SP23048-21	0197-A2	Camshaft Locking Tool - Inlet	
SP23048-27	0197-A1	Camshaft Locking Tool - Exhaust	
SP23048-23	119-552	Camshaft Alignment Clamp	
SP23048-24	0197-B	Crankshaft Setting Pin	
SPSSM6X30	Screws	M6 Setscrews (3)	○○○

Optional Extras:

- SP23048-14 (119 340) - Timing Chain Pre-Tensioning Tool
See page 228 for further details

Parts from kit 07758600 (Below)

**Peugeot 1.4 / 1.6 Petrol Engine Timing Kit
07758600**
P CHAIN

- Set of locking tools required for correct valve timing on chain driven engines
- Applications:
Peugeot 207/CC ('07-)
Peugeot 208 ('12-)
Peugeot 308/CC ('07-)
Peugeot 508 ('11-)
Peugeot 3008 ('09-)
Peugeot Partner ('09-)
Peugeot RCZ ('10-)
- Engine Codes:
1.4VTI - EP3/C 8FP, 8FR, 8FS
1.6VTI - EP6/C 5FK, 5FS, 5FW
1.6 - GT/THP EP6CDTE/X/DT 5FN, 5FR, 5FT, 5FU, 5FV, 5FX, 5FY

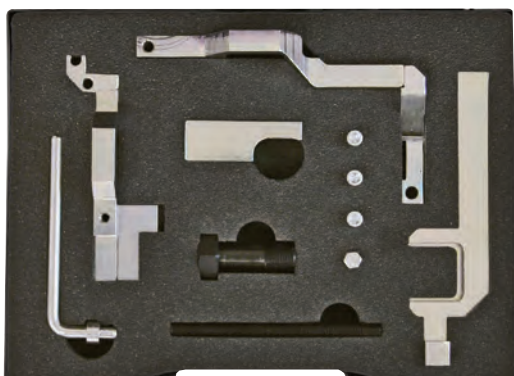

Spare Parts:			
Part No.	OEM Ref.	Description	Image ID
SPSSM6X30	Screws	M6 Setscrews (3)	○○○
SP23048-14	119-340	Timing Chain Pre-Tensioning Tool	
SP23048-24	0197-B	Crankshaft Setting Pin	
SP23048-23	119-552	Camshaft Alignment Clamp	
SP23048-26	0197-A3	Inlet Camshaft Locking Tool (2 parts)	
SP23048-21	0197-A2	Camshaft Locking Tool - Inlet	
SP23048-27	0197-A1	Camshaft Locking Tool - Exhaust	

Peugeot Petrol Engine Timing Kit
07754300

P BELT

- Set of locking tools required for cam belt service
- Applications:

Peugeot 106 ('91-'03)
 Peugeot 1007 ('05-)
 Peugeot 206 ('98-)
 Peugeot 206CC ('09-)
 Peugeot 207 ('06-)
 Peugeot 306 ('93-)
 Peugeot 307 ('01-)
 Peugeot 307CC ('04-)
 Peugeot 308 ('07-)
 Peugeot 406 ('95-)
 Peugeot 605 ('89-)
 Peugeot 806 ('94-)
 Peugeot Boxer ('94-)
 Peugeot Partner ('96-)

- Engine Codes:

1.0 - CDY, CDZ
 1.1 - HDY, HDZ, HFX, HFY, HFZ
 1.4 - KDX, KDY, KDZ, KFX, KFZ
 1.6/GTI - BFZ, NFT, NFU, NFW, NFX, NFY, NFZ
 1.8 - LFW, LFX, LFY, LFZ
 2.0 - R5A, RFS, RFT, RFU, RFV, RFW, RFX, RFY,
 RFZ, RGX, RGY



Spare Parts:			
Part No.	OEM Ref.	Description	Image ID
SP23053	0132-X 4507-TJ 9767.89	Tensioning Tool	
SP23055-01	0132-Q 5711-TA	Crankshaft Locking Pin	
SP23055-02	0132-R	Camshaft Alignment Pin (2)	
SP23055-05	0132-QZ	Crankshaft Locking Pin	
SP23055-06	0189-C	Crankshaft Locking Tool	
SP23061-02	0153-G 0153-Y 0153-N 0188-D 7004-TG 7014-TJ 7017-TR 9767.34	Crankshaft Locking Pin	
SP23069-25Z	0189-B	Camshaft Alignment Pin	
SP23069-33	0132-AJ2	Camshaft Alignment Pin	
SP23069-34	5711-TC	Camshaft Alignment Pin	
SP23069-36	0189-A	Camshaft Alignment Pin	
SP23069-37	0189-AZ	Camshaft Alignment Pin	
SP23069-46	0134-AF 0134-C	Flywheel Locking Tool	
SP23069-51	7017-TW	Tension Wrench	
SP23069-53	0132-AK 0187-J 0188-K 0189-K 4533-TAD	Belt Retention Clip	
SP23111-02	0153-A 6012-T 9765.54 9044-T	Flywheel Locking Tool	

Peugeot 1.8 -2.2 Petrol Engine Timing Kit
07754100
P **BELT**

- A range of timing tools for the latest EW coded PSA engine
- Applications:
 - Peugeot 206/CC ('98-)
 - Peugeot 307/307CC ('01-)
 - Peugeot 308 ('08-)
 - Peugeot 406/Coupe ('00-)
 - Peugeot 407 ('04-)
 - Peugeot 607 ('00-)
 - Peugeot 806 ('00-'02)
 - Peugeot 807 ('02-)
 - Peugeot Expert ('00-)
- Engine Codes:
 - 1.8 16V - (EW7J4) 6FY, 6FZ
 - 2.0 16V - (EW10A/J4/S/L5) RFJ, RFK, RFN, RFR
 - 2.0 HPI - (EW10D) RLZ
 - 2.2 16V - (EW12J4/L5) 3FY, 3FZ



Spare Parts:			
Part No.	OEM Ref.	Description	Image ID
SP23055-06	0189-C	Flywheel Locking Pin	
SP23061-12	0189-R	Flywheel / Drive Plate Locking Pin	
SP23061-14	0189-S1	Tensioner Adjusting Tool	
SP23061-15	0189-S2	Tensioner Locking Tool	
SP23069-04	0132-AB 4527-T-S2	Camshaft Locking Pin 5mm (2)	
SP23069-25Z	0189-B	Crankshaft Timing Pin	
SP23069-33	0132.AJ2 0188-M 4533-TAC2	Tensioner Setting Pin	
SP23069-36	0189-A	Camshaft Timing Pin	
SP23069-37	0189-AZ	Camshaft Timing Pin	
SP23069-38	0189-L	Inlet Camshaft Timing Pin (VTC)	
SP23069-53	0132-AK 0153-AK 0187-J 0188-K 0189-K 4533-TAD	Timing Belt Retaining Clip	

Peugeot 1.4 / 1.6 Diesel Engine Timing Pin Kit
07763900
D **BELT**

- A set of timing pins required for belt renewal
- Applications:
 - Peugeot 107 ('05-)
 - Peugeot 1007 ('06-)
 - Peugeot 206+/CC ('01-)
 - Peugeot 207 ('06-)
 - Peugeot 208 ('12-)
 - Peugeot 307 ('01-)
 - Peugeot 308/CC ('07-)
 - Peugeot 407 ('04-)
 - Peugeot 508 ('11-)
 - Peugeot 3008 ('09-)
 - Peugeot Bipper ('08-)
 - Peugeot Expert III ('07-)
 - Peugeot Partner ('08-)



- Engine Codes:
 - 1.4D HDI - 8HP, 8HR, 8HS, 8HT, 8HX, 8HZ
 - 1.6D HDI - 9HD, 9HJ, 9HL, 9HN, 9HP, 9HR, 9HS, 9HT, 9HU, 9HV, 9HW, 9HX, 9HY, 9HZ

Parts from kit 07752200 (page 175) and 07753600 (page 178)

Spare Parts:			
Part No.	OEM Ref.	Description	Image ID
SP23060-11	0194-C	Flywheel Locking Pin	
SP23069-04	0194-A	Camshaft / Fuel Pump Alignment Tool	
SP23069-25Z	0194-B	Camshaft Sprocket Locking Tool	

Peugeot Diesel Engine Timing Kit
07754400

D BELT

- Set of locking tools required for cam belt service
- Applications:
 - Peugeot 106 ('94-)
 - Peugeot 206 ('98-'04)
 - Peugeot 306 ('93-)
 - Peugeot 406 ('96-'00)
 - Peugeot 605 ('89-'99)
 - Peugeot 806 ('95-'00)
 - Peugeot Boxer ('94-'02)
 - Peugeot Expert ('96-'06)
 - Peugeot Partner ('96-'02)
- Engine Codes:
 - 1.5D - VJY, VJZ
 - 1.8D - A9A
 - 1.9D - D9B, DJY, DJZ, WJY, WJZ
 - 1.9TD - D8A, D8B, D8C, DHW, DHY, DHX
 - 2.1D/TD - P8C, P9A, PHZ
 - 2.5D/TD - T8A T9A, THX, THY, THZ



Spare Parts:			
Part No.	OEM Ref.	Description	Image ID
SP23061-02	0153-G 0153-Y 0153-N 0188-D 7004-TG 7014-TJ 7017-TR 9767.34	Crankshaft Locking Pin	
SP23061-03	N/A	M8 x 35 Setscrew (2)	
SP23061-04	N/A	M8 x 40 Setscrew (1)	
SP23061-09	N/A	M8 x 80 Setscrew	
SP23061-06	7017-TR	Flywheel Locking Pin	
SP23061-11	0118-X	Crankshaft Locking Pin and Spring	
SP23069-25Z	0189-B 0194-B	Timing Pin	
SP23069-44	0178-E	Tension Wrench	
SP23069-04	0132-AB 4527-TS2 5711.TD 0194-A	Camshaft Timing Pin	
SP23069-46	0134-AF 0134-C	Flywheel Locking Tool	
SP23101	1.860.638.000	Tension Spacer	
SP23111-02	0153-A 6012-T 9765.54 9044-T	Flywheel Locking Tool	
SP23069-53	0132-AK 0187-J 0188-K 0189-K 4533-TAD	Belt Retention Clip	

Peugeot 2.7HDI Diesel Engine Timing Kit
07754200

D BELT

- Set of locking tools required for cam belt service
- Applications:
 - Peugeot 407 ('04-)
 - Peugeot 607 ('04-)
- Engine Codes:
 - 2.7HDI - UHZ

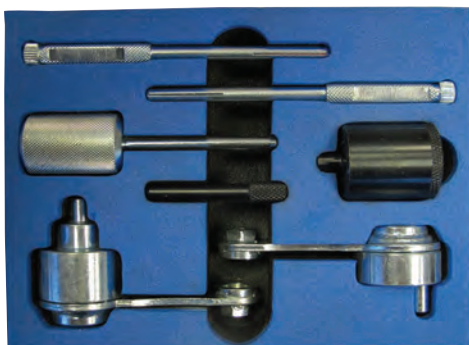

Spare Parts:			
Part No.	OEM Ref.	Description	Image ID
SP23079	303-1132	Camshaft Sprocket Alignment Tool	
SP23061-21Z	303-1126 0195-H	Camshaft Sprocket Alignment Pins (2)	
SP23079-03Y	303-1117	Flywheel Locking Tool – Automatic Transmission	
SP23079-02Z	303-1116	Flywheel Locking Tool – Manual Transmission	
SP23061-18X	0195-K	Flywheel Locking Tool	
SP23061-19X	0195-C	Coolant Pump Pulley Pin	

Peugeot 2.0 / 2.2HDI Diesel Engine Timing Kit 07764000

D BELT

- Set of locking tools required for cam belt service
- Applications:
 - Peugeot 206 ('99-)
 - Peugeot 307/CC ('00-)
 - Peugeot 308/CC ('07-)
 - Peugeot 406 ('98-)
 - Peugeot 407 ('04-)
 - Peugeot 508 ('11-)
 - Peugeot 607 ('00-)
 - Peugeot 806 ('99-)
 - Peugeot 807 ('02-)
 - Peugeot 3008 ('09-)
 - Peugeot 4007 ('07-)
 - Peugeot Boxer 11 ('02-)
 - Peugeot Expert ('99-)
 - Peugeot Partner ('00-)
 - Peugeot RCZ ('10-)
- Engine Codes:
 - 2.0HDI - RHC, RHD, RHE, RHF, RHG, RHH, RHK, RHL, RHM, RHR, RHS, RHT, RHV, RHW, RHY, RHX, RHZ
 - 2.2HDI - 4HK, 4HL, 4HN, 4HP, 4HR, 4HS, 4HT, 4HW, 4HX, 4HY, 4HZ

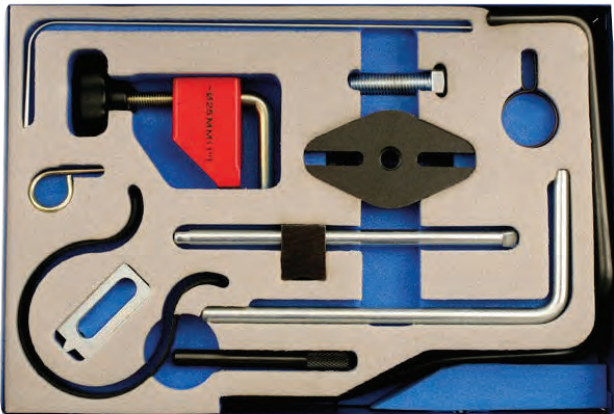

Spare Parts:			
Part No.	OEM Ref.	Description	Image ID
SP23061-07X	0188-Y	Crankshaft Locking Pin (8mm)	
SP23069-53X	0188-M	Camshaft Locking Pin	
SP23069-57	0188-X	Flywheel Locking Pin	
SPE10434	0188-Q1	Auxiliary Drive Belt Tensioner Locking Pin (4mm)	
SP23060-19Z	0188-K	Cam Belt Retaining Clip	
SP23061-24	0188-F	Flywheel Holding Tool	
SP23069-46Z	0188-J2	Cam Belt Tensioner Tool	
SP23069-49A	0188-P	Crankshaft Pulley Puller / Extractor	
SP23069-33X	0153-AL 4200-TA	Cam Belt Tensioner Locking Pin	
SPE10095-01	0188-AH	Crankshaft Pulley Centralisation Tool	
SPE10095-02	0188-AD	Cam Belt Clamp	
SP23060-08Z	0188-Q2	Auxiliary Belt Tensioner Locking & Crank Pinion Alignment Tool	

Peugeot 2.8HDI Diesel Engine Timing Kit 07751500

D BELT

- Set of locking tools required for cam belt service
- Applications:
 - Peugeot Boxer I / II ('00-)
- Engine Codes:
 - 2.8HDI - 8140.43S, 8140.43N

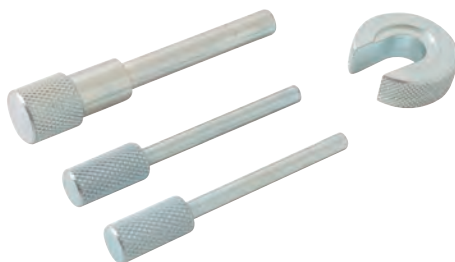

Spare Parts:			
Part No.	OEM Ref.	Description	Image ID
SP23101	1.860.638.000	Tensioning Tool	
SP23069-23	MOT 1054	Camshaft Locking Pin	
SP23069-22	MOT 910	TDC Timing Pin (2)	

**Peugeot 2.2 / 3.0HDI Diesel Engine Timing Kit
07764500**

D BELT CHAIN

- Set of tools for maintenance on chain driven engines
- Applications:
Peugeot Boxer III ('06-)
Peugeot Jumper Relay III ('06-)
- Engine Codes:
2.2HDI - 4HG, 4HH, 4HJ, 4HM, 4HU, 4HV
3.0HDI - F1CE0381D, F1CE0381E, F1CE0481D, F1CE03481DM (F30DTE)

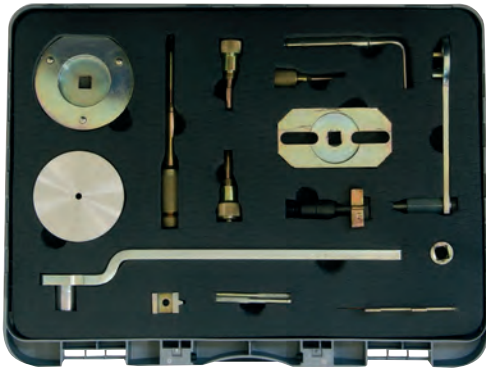

Spare Parts:			
Part No.	OEM Ref.	Description	Image ID
SP310125001	2.000.016.900	Crankshaft Seal Fitting Tool	
SP310125005	2.000.017.000	Timing Cover Centering Plate	
SP310125003	2.000.018.400	Crankshaft Pulley Turning Tool	
SP310125004	2.000.019.200	Flywheel Locking Tool	
SP310125007	2.000.016.500	Camshaft Gear Setting Rod	
SP310125009	2.000.016.700	Oil Pump Setting Plate	
SP310125010	2.000.017.300	Water Sensor Installation Socket	
SP313106000	1.860.846.000	Flywheel Locking Tool	
SP310125008	1.860.815.000	Crankshaft Pulley Mounting Plate	
SP23100-01	99360614	Camshaft Timing Pin (2)	
SP23100-02	99360615	Crankshaft Timing Pin	
SP23069-04	1.860.617.000	Injection Pump Locking Pin	
SP310125006	2.000.017.100	Flywheel Locking Tool	
SP310125002	2.000.018.700	Flywheel Locking Tool	

ENGINE TIMING



**FOR THE LATEST
PRODUCT INFORMATION
VISIT OUR NEW WEBSITE:
www.sykes-pickavant.com**

Renault 1.2 Petrol Engine Timing Kit
07764200
P BELT

- Set of locking tools required for cam belt service
- Applications:
Renault Clio 2 / Kangoo ('98-)

- Engine Codes:
1.2 - D7F 710/720/722/726/744/
746/764/766
1.2 16v - D4F 706/712/712/714/
716/722/728/730

Spare Parts:

Part No.	OEM Ref.	Description	Image ID
SP23069-23Z	MOT 1054	Crankshaft Timing Pin	
SP23069-43	MOT 1386	Tension Adjuster	

Renault Twin Cam 16v Petrol Engine Timing Kit
07755100
P BELT

- Set of locking tools required for cam belt service
- Applications:

Renault Avantage ('00-'03)
Renault Clio 2 ('99-)
Renault Clio 3 ('05-)
Renault Espace ('98-'02)
Renault Espace 1V ('02-)
Renault Kangoo ('01-)
Renault Kangoo II ('08-)
Renault Laguna 1 ('97-)
Renault Laguna 2 ('01-)
Renault Laguna 3 ('07-)
Renault Logan ('04-)
Renault Megane ('99-)
Renault Megane II ('02-)
Renault Megane III ('08-)
Renault Modus ('04-)
Renault Modus Grand ('08-)
Renault Scenic ('99-)
Renault Scenic II ('03-)
Renault Scenic III ('09-)
Renault Traffic II ('01-)
Renault Twingo II ('08-)
Renault Vel Satis ('00-)

- Engine Codes:

1.4 16v

K4J 700/710/711/712/713/714/715/730/732/740/750/770/780

1.6 16v/GT

 K4M 690/700/701/704/706/708/709/710/711/712/714/716/718/720/724/730/732/734/740/742/743/
744/745/746/748/750/752/753/760/761/764/766/782/790/791/792/794/800/801/802/804/812/813/
824/830/831/834/846/848/854/858/862/866

1.8 16v

F4P 720/722/760/770/771/772/773/774/775/780

2.0 16v/T

 F4R 700/701/712/713/714/715/720/721/722/730/732/770/771/790/791/792/820/830/832
F4RT 740/741/746/762/763/764/765/767/774/776/784/786/787/794/795/796/797/800/802/810/811/
867/874/886/887/896/897

Spare Parts:

Part No.	OEM Ref.	Description	Image ID
SP23054-04	MOT 1489	Crankshaft Timing Pin	
SP23069-23	MOT 1054	Crankshaft Timing Pin	
SP23069-52	MOT 1496	Camshaft Setting Tool	

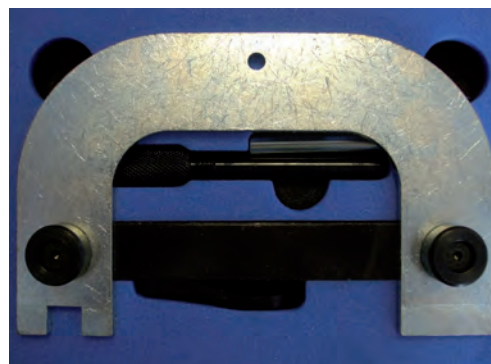

Renault Petrol & Diesel Engine Timing Kit

07755700

P **D** **BELT**

- Set of timing pins enabling correct valve timing
- Applications:

Renault Clio ('91-'98)	Renault Master ('00-)
Renault Clio 2 ('01-)	Renault Modus ('04-)
Renault Clio 3 ('05-)	Renault Modus Grand ('08-)
Renault Espace ('96-)	Renault Scenic ('99-)
Renault Kangoo ('00-)	Renault Scenic II ('03-)
Renault Kangoo II ('08-)	Renault Scenic III ('09-)
Renault Laguna I ('94-)	Renault Traffic ('97-'01)
Renault Laguna III ('07-)	Renault Twingo I ('93-)
Renault Logan ('04-)	Renault Twingo II ('07-)
Renault Megane ('96-)	
Renault Megane II ('02-)	
Renault Megane III ('08-)	

- Engine Codes:

1.2 - D7F 700/701/702/703/704/706/708/800/782
D4F/T 702/704/708/740/742/764/784

1.5 DCI - K9K 700/702/704/706/710/712/714/716/718/722/724/728/729/
732/734/740/750/752/760/764/766/768/772/774/782/790/792/
794/796/800/802/804/806/808/820/830/832/834/836

1.6 K7M - 710/744/745/850

1.8 - F3P 710/712/714/720/724/670/674/676/678/755/758

1.9D - F8Q 600/606/620/622/624/630/632/662//730/732/784/786/790

1.9DT/I - F9Q 710/716/717/720/722/730/731/734/736/744/770/780/782/870/872

2.0 - F3R/RJ/RK 611/722/723/724/728/729/732/734/742/750/751/752/768/769/791/796/797/798

2.0 16v - F7R 710/714

Spare Parts:

Part No.	OEM Ref.	Description	Image ID
SP23054-04	MOT 1489	Crankshaft Timing Pin	
SP23069-23	MOT 1054	Timing Pin	
SP23069-25Z	MOT 1430	Crankshaft Timing Pin	

Note: Parts from kit 07755200 (See below)



Renault 1.9 / 2.2 / 2.5 Diesel Engine Timing Kit

07755200

D **BELT**

- Applications:

Renault Espace ('00-'02)	Renault Megane ('99-)
Renault Espace 1V ('02-)	Renault Megane II ('02-)
Renault Kangoo ('01-)	Renault Scenic ('00-)
Renault Laguna 1 ('99-'01)	Renault Scenic II ('03-)
Renault Laguna 2 ('04-)	Renault Traffic II ('01-)
Renault Master ('01-)	Renault Vel Satis ('02-)

- Engine Codes:

1.9 DCI - F9Q 650/660/664/670/674/680/690/718/732/733/
740/748/750/751/752/754/755/759/760/762/772/
774/790/800/803/804/808/812/814/818/820/826

2.2 DCI - G9T 600/605/606/607/642/643/645/700/702/703/
706/707/710/720/722/742/743/750

2.5 DCI - G9U 630/632/650/720/724/726/730/750/754



Spare Parts:

Part No.	OEM Ref.	Description	Image ID
SP23164-18	MOT 1536 KM-6203	Flywheel Setting Pin	
SP23164-19	MOT 1537 KM-6204	Camshaft Locking Tool - Exhaust	
SP23164-19E	N/A	Locking Screw M8 x 60 mm (2)	
SP23164-20	MOT 1534 KM-6205	Camshaft Locking Tool - Inlet	
SP23164-17	MOT 1538	Hi-Pressure Fuel Pump Pulley Locking Pin	
SP23054-04	MOT 1489	Crankshaft Timing Pin	
SP23061-08	N/A	Tensioning Screw M6 x 45 mm	
SP23069-23	MOT 1054	Flywheel Locking Pin	
SP23069-25Z	MOT 1430	Camshaft Timing Pin	
SP23069-59	MOT 1543	Tension Pre-setting Tool	

Note: This kit includes all components from Kit 07755700 (See above)

Renault 2.0DCI / 2.3DCI Diesel Engine Timing Kit
07755500
D
CHAIN

- Set of locking tools required for correct valve timing on chain driven engines
- Applications:
 Renault Espace 1V ('06-)
 Renault Koleos ('08-)
 Renault Laguna 2 ('05-'07)
 Renault Laguna 3 ('07-)
 Renault Megane II ('06-)
 Renault Megane III ('09-)
 Renault Master III ('10-)
 Renault Scenic II ('06-)
 Renault Scenic III
 Renault Traffic II ('06-)
 Renault Vel Satis ('05-)
- Engine Codes:
 2.0DCI - M9R 610/613/615/700/721/722/724/740/742/760/
 761/762/763/780/782/784/786/788/800/802/805/
 808/814/815/820/830/832/833/845/849
 2.3DCI - M9T 670/672/676/680/686/690/692/694/698



Spare Parts:			
Part No.	OEM Ref.	Description	Image ID
SP23069-04Z	N/A	Tensioner Locking Pin 2.9mm	
SP23069-75Z	MOT 1770 EN-48334	Crankshaft Pulley Holding Tool	
SP23069-76	MOT 1769 EN-48332	Camshaft Setting Tool	
SP23069-77	MOT 1773 EN-48331	Camshaft Gear Alignment Tool	
SP23069-78Z	PIN 3.6MM KM-6130	Auxiliary Belt Tensioner Locking Pin	
SP23069-79X	MOT 1766 EN-48330	Crankshaft Locking Pin (2.0 DCi)	

Renault 2.5 / 2.8 Diesel Engine Timing Kit
07751500
D
BELT

- Set of locking tools required for cam belt service
- Applications:
 Renault Master ('80-)
 Renault Traffic ('89-'01)
- Engine Codes:
 2.5D - S8U 720/722/730/731/742/748/750/752/758/770/772
 2.5TD - S9U704/714
 2.8 D DCI/DTI - S9W 206/208/212/700/702

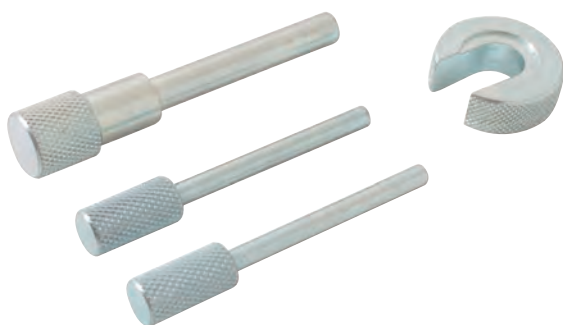

Spare Parts:			
Part No.	OEM Ref.	Description	Image ID
SP23101	1.860.638.000	Tensioning Tool	
SP23069-23	MOT 1054	Camshaft Locking Pin	
SP23069-22	MOT 910	TDC Timing Pin (2)	

Rover Camshaft Locking Tool
02240000

- Applications: Rover 100, 200, 25, 400, 45, 75, Metro & Streetwise ('90-'06)
- Engine Codes:
1.1, 1.4, 1.6, 1.8 - K8, K16, 14K, 16K
- OEM Reference: 18G 1570



P BELT

Rover Flywheel Locking Tool
SP23111-14

- For use with PG1 Gearbox
- Applications: Rover 218, 25, 45 & Streetwise ('98-'05)
- Engine Codes: 1.4, 1.8 - K16
- OEM Reference: 18G 1742



P BELT

Rover Flywheel Locking Tool
SP23111-12

- For use without PG1 Gearbox
- Applications: Rover 100, 200, 25, 400, 45 ('90-'06)
- Engine Codes: 1.1, 1.4 - K16, 14K
- OEM Reference: 18G 1571



P BELT

Rover 75 Flywheel Locking Tool
SP23111-11

- Applications: Rover 75 ('90-'06)
- Engine Codes: 1.8 - K16, K18
- OEM Reference: 12-170



P BELT

Rover 2.0 / 2.5 Petrol Engine Timing Kit
07761000

- Set of locking tools required for cam belt service
- Applications:
Rover 45 ('99-'05)
Rover 75 ('99-'05)
Rover 825 ('96-'99)
- Engine Code:
2.0 / 2.5 - KV6 (except 190)

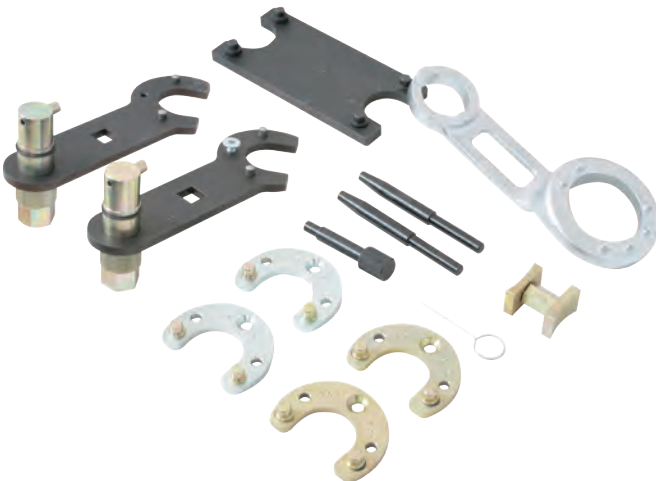

P BELT

Spare Parts:

Part No.	OEM Ref.	Description	Image ID
SP23078-01	18G 1747	Camshaft Locking Tool	
SP23078-02	12-187	Camshaft Locking Adaptor - 2.0l	
SP23078-03	12R208	Camshaft Locking Adaptor - 2.5l	
SP23078-04	12-175	Rear Camshaft Sprocket Setting Tool	
SP23161-06	N/A	Tensioner Pushrod Retension Pin	
SP23078-06	N/A	Rear Camshaft Sprocket Setting Tool	
SP23078-07	18G 1746A LRT 12-198	Rear Camshaft Sprocket Guide Pin	
SP23078-08	18G 1747-5 LRT 12-232	Crankshaft Locking Pin	
SP23078-09	18G 1747-1 LRT 12-195	Rear Cam Sprocket Spreader	

Saab 2.5 / 3.0 Petrol Engine Timing Kit 07753500

P BELT

- Set of locking tools required for cam belt service
- Applications:
Saab 900 ('93-'98)
Saab 9-5 ('98-'03)
Saab 9000 ('95-'97)
- Engine Codes:
2.5 - B258I
3.0 - B308E, B308i



Spare Parts:			
Part No.	OEM Ref.	Description	Image ID
SP23047-01	KM800-10	Camshaft Locking Tool	
SP23047-02	KM800-20	Crankshaft Timing Gauge	
SP23047-03	KM800-2	Camshaft Locking Tool (LH) Green	
SP23047-04	KM800-1	Camshaft Locking Tool (RH) Red	
SP23047-05	KM800-30	Belt Holding Wedge	

Saab 1.9D TID / TTID Diesel Engine Timing Kit 07764700

D BELT

- Set of locking tools required for cam belt service
- Applications:
Saab 9-3 ('04-)
Saab 9-5 ('05-)
- Engine Codes:
1.9D TID - Z19DT,
Z19DTH
1.9 TTID - Z19DTR



Spare Parts:			
Part No.	OEM Ref.	Description	Image ID
SP23111-06Z	1.860.898.000	Flywheel Holding Tool	
SP23174-04X	32 025 008	Camshaft Alignment Pins (2)	
SP23111-08	32 025 009	Crankshaft Alignment Tool	
SP23069-07X	87 92 335	Crankshaft Alignment Pin	
SP23174-05	EN46789-100	Camshaft Alignment Screw	

Saab 2.2D / TID Diesel Engine Timing Kit 07753300

D CHAIN

- Set of locking tools required for correct valve timing on chain driven engines
- Applications:
Saab 9-3 ('98-'04)
Saab 9-5 ('02-'06)
- Engine Code:
2.2 - D223L



Spare Parts:			
Part No.	OEM Ref.	Description	Image ID
SP23164-05	KM-933 83 95 394	Timing Adjustment Wrench	
SP23164-06	83 95 394	Timing Adjustment Bracket Assembly	
SP23164-07	83 95 337	Injection Pump Setting Pin	
SP23164-08	83 95 352	Flywheel Locking Pin	
SP23164-09	83 95 386	Camshaft Timing Tool	

Seat 1.2 TSI Petrol Engine Timing Kit 07763600

P

CHAIN

- Set of locking tools required for chain maintenance
- Applications:
Seat Altea ('10-)
Seat Ibiza ('10-)
Seat Toledo ('12-)
- Engine Codes:
1.2TSI - CBZA, CBZB



Parts from kit 07763400 (below)

Spare Parts:

Part No.	OEM Ref.	Description	Image ID
SP23191-02X	T10340	Crankshaft Locking Pin	
SPE10436	T10414	Camshaft Locking Tool	

Optional Extras:

- 07763700 (T10172) - Sprocket Holding Tool
See page 230 for further details

Seat 1.2 TSI, 1.4T / FSI, 1.6 Petrol Engine Timing Kit 07763400

P

CHAIN

- Set of locking tools required for chain maintenance
- Applications:
Seat Alambra ('10-)
Seat Altea ('10-)
Seat Cordoba ('06-)
Seat Ibiza ('06-)
Seat Leon ('07-)
Seat Toledo ('12-)
- Engine Codes:
1.2TSI - CBZA, CBZB
1.4T/FSI - BTS, CAVA, CAVE, CAVF, CAXC, CTHA
1.6 - BTS



Spare Parts:

Part No.	OEM Ref.	Description	Image ID
SPE10436	T10414	Camshaft Locking Tool	
SP23072-A	VAS 6079	Dial Test Indicator 41 x 8mm	
SP23107-B	T10170	TDC Indicator	
SP23162-41	T10171/A	Camshaft Alignment Tool	
SP23161-06	T20046 T40011	Tensioner Pin	
SP23191-02X	T10340	Crankshaft Locking Pin	
SP23191-01	T10341	Guide Pins (2)	

Optional Extras:

- 07763700 (T10172) - Sprocket Holding Tool
See page 230 for further details

Seat 1.2 6v/12v - 3 Cyl. Petrol Engine Timing Kit 07756100

P

CHAIN

- Set of locking tools required for chain maintenance
- Applications:
Seat Cordoba ('03-)
Seat Ibiza ('02-)
- Engine Codes:
1.2 - AZQ, BBM, BME, BXV, BZG, CGPA, CGPB



Spare Parts:

Part No.	OEM Ref.	Description	Image ID
SP23176-01	T10123	Camshaft Aligning Tool (2)	
SP23176-02	T10120	Camshaft Aligning Tool	
SP23176-03	T10121	Crankshaft Locking Tool	

Optional Extras:

- 07763700 (T10172) - Sprocket Holding Tool
See page 230 for further details

Camshaft Alignment Locking Tool
07756014
P BELT

- Locking tool required for cam belt service

- Applications:

Seat Altea ('06-)
 Seat Arosa ('98-)
 Seat Cordoba ('98-)
 Seat Ibiza ('98-)
 Seat Inca ('00-)
 Seat Leon ('00-)
 Seat Toledo ('99-)

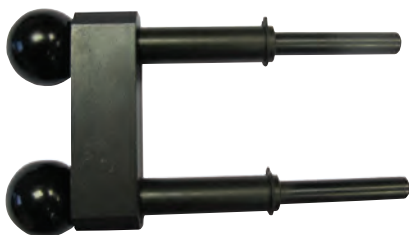

- Engine Codes:

1.4 - AFK, AHW, APE, AQQ, AUA, AUB, AXP, BBY, BBZ, BCA, BKY, BXW, CGGB
 1.6/GTI - AUS, AZD, BCB

Spare Parts:

Part No.	OEM Ref.	Description	Image ID
07756014	T10016 T10074	Camshaft Alignment Locking Tool	

Optional Extras:

- 07767100 (3415) - Crankshaft Pulley Holding Tool
See page 231 for further details

Tool found in kit 077560V2 - see page 147
Seat 1.8 Petrol Engine Timing Kit
07757200
P BELT CHAIN

- Set of tools required for belt and chain service

- Applications:

Seat Alhambra ('97-)
 Seat Ibiza ('99-)
 Seat Leon ('99-)

- Engine Codes:

1.8 - AGN, AJH, AJQ, AUQ, APG, APP, APT, APY, AQX, ARY, AWC, AYP, BAM, BBU, BJX, BKV, BLZ

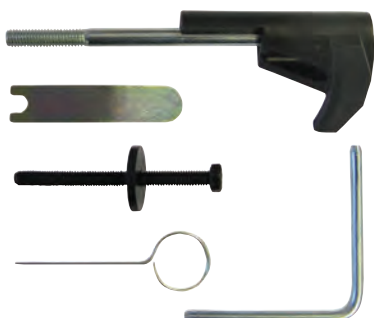
Spare Parts:

Part No.	OEM Ref.	Description	Image ID
SP23161-06	T40011 T20046	Tensioner Locking Pin	
SP23161-93	T10092	Tensioning Bolt	
SP23161-92	3366	Chain Tensioner Retainer	
SP23069-12	T10008	Tensioner Locking Tool	
SP23161-96	T10060/A	Auxiliary Drive Belt Tensioner Pin	

Optional Extras:

- 07752400 (3036) - Sprocket Holding Wrench
- 07756005 (T10020 / V159) - Multi-Position Tensioner Wrench
- 07756900 (3369) - Guide Pin Set
See pages 229-231 for further details

Seat 2.0T / FSI Petrol Engine Timing Kit
07756700
P BELT CHAIN

- Set of tools required for belt and chain service

- Applications:

Seat Altea ('05-) Seat Leon ('06-)
 Seat Exeo ('09-) Seat Toledo ('04-'09)

- Engine Codes:

2.0T/FSI - BWA, BWE, BLR, BLY, BVY, BVZ, CDLA, CDLD
 2.0TFSI - BWA, BWA1, BWJ

Spare Parts:

Part No.	OEM Ref.	Description	Image ID
SP23044-04	T10020	Tension Wrench	
SP23161-06	T40011	Tensioner Locking Pin	
SP23161-91	T10252	Camshaft Alignment Tool	
SP23161-92	3366	Chain Tensioner Retainer	
SP23161-93	T10092	Chain Tensioner Retaining Screw & Nut	
SP23161-96	T10060/A	Auxiliary Drive Belt Tensioner Pin	

Optional Extras:

- 07756900 (3369) - Guide Pin Set
See page 230 for further details

Seat 1.4 / 1.9 / 2.0 PD Diesel Engine Timing Kit

077562V2

D

BELT

- Set of locking tools required for cam belt service
- Applications:

Seat Alhambra ('99-)	Seat Ibiza ('03-)
Seat Altea ('04-)	Seat Leon ('00-)
Seat Arosa ('99-)	Seat Toledo ('00-)
Seat Cordoba ('03-)	
- Engine Codes:

1.4TDI PD - AMF, BMS, BNM, BNV
1.9TDI PD - ANU, ARL, ASZ, ATD, AUY, AXR, BJB, BKC, BLS, BLT, BMT, BPX, BTB, BUK, BVK, BXE, BXF, BXJ
2.0TDI PD - AZV, BKD, BMM, BMN, BRT, BVH

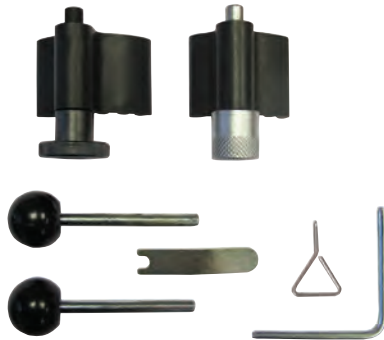

Components can be found in Master Kit - 077560V2
See page 147 for details

Spare Parts:

Part No.	OEM Ref.	Description	Image ID
SP23069-11	T20102/3359	Injection Pump Timing Pin 6mm Dia.	
SP23161-94	T10115	Tensioner Locking Pin	
SP23161-03	T10050	Crankshaft Sprocket Alignment Tool	
SP23161-03C	T10100	Crankshaft Sprocket Alignment Tool	
SP23069-12	T10008	Tensioner Locking Tool	
SP23161-96	T10060/A	Auxiliary Drive Belt Tensioner Pin	

Optional Extras:

- 07756005 (3387 / T10020) - Multi-Position Tensioner Wrench
 - SP23161-07 (3369) - Support Guides
 - 07756006 (T10264 / T10265 / T40098) Tensioner Pulley Locking Pin Set
 - 07763700 (T10172) - Sprocket Holding Tool
- See pages 230 - 231 for further details

Seat 1.7 / 1.9 Diesel Engine Timing Kit

07757900

D

BELT

- Set of locking tools required for cam belt service
- Applications:

Seat Alambra ('96-'00)
Seat Arosa ('99-'05)
Seat Cordoba ('93-)
Seat Ibiza ('93-)
Seat Inca ('95-)
Seat Leon ('99-)
Seat Toledo ('94-)
- Engine Codes:

1.7SDI - AKW, AKU
1.9D - 1Y
1.9TD - AAZ
1.9TDI - 1Z, AFN, AGR, AHF, AHU, ALH, ASV, AVG
1.9SDI - AEY, AGP, AQM, AYQ



Components can be found in Master Kit - 077560V2
See page 147 for details

Spare Parts:

Part No.	OEM Ref.	Description	Image ID
SP23161-B	3418 T20038	Camshaft Aligning / Locking Tool	
SP23062-B	2065A U40021	Camshaft Setting Bracket	
SP23069-11	T20102 U40074 3359	Injection Pump Timing Pin - 6mm dia	
SP23061-01	2064 U20003	Injection Pump Timing Pin 15.4mm dia	

Optional Extras:

- 07756005 (T10020 / V159) - Multi-Position Tensioner Wrench
 - 07752400 (3036) - Sprocket Holding Wrench
 - SP23161-07 (3369) - Support Guides
- See pages 230 - 231 for further details

Seat 1.2 - 2.0 Common Rail Diesel Engine Timing Kit
07757100
D BELT

- Designed to fit the newest common rail diesel engines which are significantly different from the older PD engines
These CR engines combine belt and gear drives by using a toothed belt to transfer the drive from the crankshaft to one of the cam shafts then using gears to transfer the drive from one cam to the other

- Applications:
Seat Alhambra ('10-)
Seat Altea ('09-)
Seat Exeo ('09-)
Seat Ibiza ('10-)
Seat Leon ('09-)
Seat Toledo ('09-)

- Engine Codes:
1.2D TDI - CFWA
1.6D TDI - CAYA, CAYB, CAYC, CLNA
2.0D TDI - CAGA, CAGC, CAHA, CFFA, CFFB, CEGA, CFGA, CFGB, CFHC, CFHD, CFJA



Spare Parts:			
Part No.	OEM Ref.	Description	Image ID
SP23069-11	T20102 3359	Injection Pump / Camshaft Alignment Pin	
SP23161-03	T10050	Crankshaft Pulley Locking Tool (Bored)	
SP23161-03C	T10100	Crankshaft Pulley Locking Tool (Non-bored)	
SP23161-81	T10264	Tensioner Pulley Adjustment tool (2.4mm Hex key)	
SP23161-83	T10265	Tensioner Pulley Locking Tool	
SP23161-96	T10060/A	Auxiliary Tensioner Locking Tool (3.9mm)	
SP23161-61	T10051	Sprocket Holding Tool	
SP23161-62	T10052	Cam Sprocket Hub Puller	
SP23161-17	T10255	Oil Pump / Balance Shaft Alignment	
Optional Extras:			
<ul style="list-style-type: none"> • 07763700 (T10172) - Sprocket Holding Tool • 07756900 (3369 / T10093) - Guide Pin Set <i>See page 230 for further details</i>			

ALTERNATOR FREE WHEEL PULLEY SET

SPECIAL SET OF SPLINE & TORX SOCKET BITS
FOR THE REMOVAL OF FREE-WHEEL
ALTERNATOR PULLEYS

SEE PAGE 48

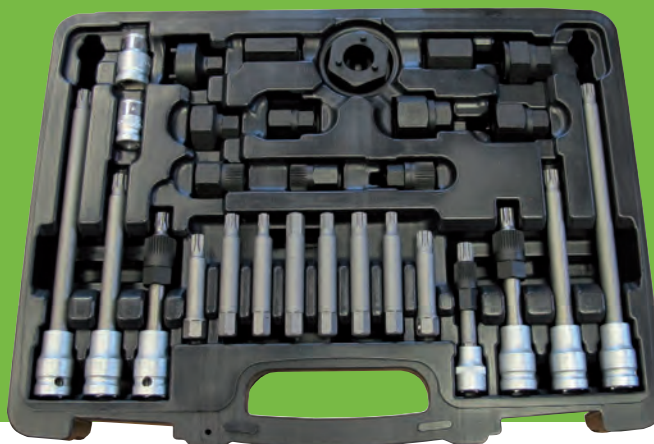

Skoda 1.2 TSI Petrol Engine Timing Kit
07763600

P CHAIN

- Set of locking tools required for chain maintenance
- Applications:
Skoda Fabia 2 ('10-)
Skoda Octavia 2 ('10-)
Skoda Rapid ('12-)
Skoda Roomster ('10-)
Skoda Yeti ('09-)
- Engine Codes:
1.2TSI - CBZA, CBZB



Spare Parts:

Part No.	OEM Ref.	Description	Image ID
SP23191-02X	T10340	Crankshaft Locking Pin	
SPE10436	T10414	Camshaft Locking Tool	

Optional Extras:

- 07763700 (T10172) - Sprocket Holding Tool
See page 230 for further details

Skoda 1.2 TSI, 1.4T, 1.4FSI, 1.6 FSI Petrol Engine Timing Kit
07763400

P CHAIN

- Set of locking tools required for chain maintenance
- Applications:
Skoda Fabia 2 ('07-)
Skoda Octavia 2 ('08-)
Skoda Rapid ('12-)
Skoda Roomster ('06-)
Skoda Superb II ('08-)
Skoda Yeti ('09-)
- Engine Codes:
1.2TSI - CBZA, CBZB,
1.4T/FSI/VRS - CAVE, CAXA, CAXC, CTHE, CAXA
1.6 - BLF, BTS, CFNA



Spare Parts:

Part No.	OEM Ref.	Description	Image ID
SPE10436	T10414	Camshaft Locking Tool	
SP23072-A	VAS 6079	Dial Test Indicator 41 x 8mm	
SP23107-B	T10170	TDC Indicator	
SP23162-41	T10171/A	Camshaft Alignment Tool	
SP23161-06	T20046 T40011	Tensioner Pin	
SP23191-02X	T10340	Crankshaft Locking Pin	
SP23191-01	T10341	Guide Pins (2)	

Optional Extras:

- 07763700 (T10172) - Sprocket Holding Tool
See page 230 for further details

Skoda 1.2 6v/12v - 3 Cyl. Petrol Engine Timing Kit
07756100

P CHAIN

- Set of locking tools required for chain maintenance
- Applications:
Skoda Fabia 2 ('02-)
Skoda Roomster ('06-)
- Engine Codes:
1.2 - AWY, AZQ, BBM, BMD, BME, BZG, CEVA, CGPA, CGPB, CHFA



Spare Parts:

Part No.	OEM Ref.	Description	Image ID
SP23176-01	T10123	Camshaft Aligning Tool (2)	
SP23176-02	T10120	Camshaft Aligning Tool	
SP23176-03	T10121	Crankshaft Locking Tool	

Optional Extras:

- 07763700 (T10172) - Sprocket Holding Tool
See page 230 for further details

Camshaft Alignment Locking Tool
07756014
P BELT

- Locking tool required for cam belt service

- Applications:
Skoda Fabia 2 ('99-)
Skoda Octavia ('00-)
Skoda Roomster ('06-)

- Engine Codes:
1.4 - AUA, AUB, AXP,
BBY, BBZ, BCA, BKY,
BUD, BXW, CGGA,
CGGB

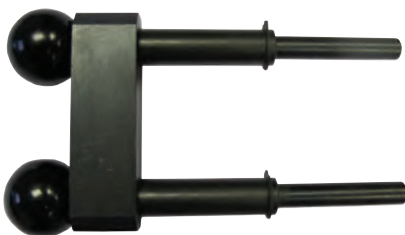
Spare Parts:

Part No.	OEM Ref.	Description	Image ID
07756014	T10016 T10074	Camshaft Alignment Locking Tool	

Optional Extras:

- 07767100 (3415) - Crankshaft Pulley Holding Tool
See page 231 for further details

Tool found in kit 077560V2 - see page 147
Skoda 2.0T / FSI / VRS Petrol Engine Timing Kit
07756700
P BELT CHAIN

- Set of locking tools required for engine service

- Applications:
Skoda Octavia (04-)

- Engine Codes:
2.0T/FSI/VRS - BLR, BLX, BLY, BVX, BVY, BVZ, BWA

Spare Parts:

Part No.	OEM Ref.	Description	Image ID
SP23044-04	T10020	Tension Wrench	
SP23161-06	T40011	Tensioner Locking Pin	
SP23161-91	T10252	Camshaft Alignment Tool	
SP23161-92	3366	Chain Tensioner Retainer	
SP23161-93	T10092	Chain Tensioner Retaining Screw & Nut	
SP23161-96	T10060/A	Auxiliary Drive Belt Tensioner Pin	

Optional Extras:

- 07756900 (3369) - Guide Pin Set
See page 230 for further details

Skoda 2.8 V6 Petrol Engine Timing Kit
07757400
P BELT

- Set of locking tools required for cam belt service

- Applications:
Skoda Superb ('02-)

- Engine Codes:
2.8 V6 - AMX, BBG

Spare Parts:

Part No.	OEM Ref.	Description	Image ID
SP23056-01	3242	Crankshaft Locking Pin	
SP23056B	3391	Twin Cam Locking Strap	

Optional Extras:

- 07757500 - VW Group V6 / V8 Camshaft Sprocket Puller
- 07756900 - VW Group Guide Pin Set
- 07752400 - Universal Sprocket Holding Wrench
See page 230 for further details

Skoda 1.8, 1.8 Turbo, 2.0 Twin Camshaft Petrol Engine Timing Kit

07757200

P BELT CHAIN

- Set of tools required for belt and chain service
- Applications:
Skoda Octavia ('96-)
Skoda Superb ('02-)
- Engine Codes:
1.8 - AGN, AGU, AUM, ARX, ARZ, AUQ, AWT

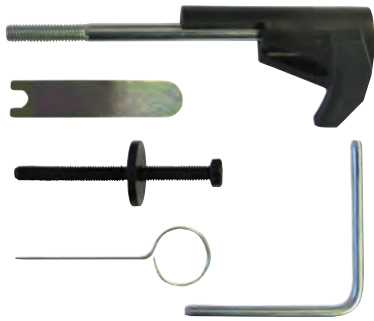

Spare Parts:			
Part No.	OEM Ref.	Description	Image ID
SP23161-06	T40011 T20046	Tensioner Locking Pin	
SP23161-93	T10092	Tensioning Bolt	
SP23161-92	3366	Chain Tensioner Retainer	
SP23069-12	T10008	Tensioner Locking Tool	
SP23161-96	T10060/A	Auxiliary Drive Belt Tensioner Pin	

Optional Extras:

- 07752400 (3036) - Sprocket Holding Wrench
- 07756005 (T10020 / V159) - Multi-Position Tensioner Wrench
- 07756900 (3369) - Guide Pin Set

See pages 229-231 for further details

Skoda 1.4 / 1.9 / 2.0 TDI PD Diesel Engine Timing Kit

077562V2

D BELT

- Set of locking tools required for cam belt service
- Applications:
Skoda Fabia 2 ('03-) Skoda Roomster ('06-)
Skoda Octavia ('02-) Skoda Superb 2 ('02-)
- Engine Codes:
1.4TDI PD - AMF, BMS, BNM, BNV
1.9TDI PD - ASZ, ATD, AVB, AVF, AWX, AXR, BJB, BKC, BLS, BLT, BPZ, BSV, BSW, BXE
2.0TDI PD - AZV, BKD, BMN, BMM, BMP, BSS



*Components can be found in Master Kit - 077560V2
See page 147 for details*

Spare Parts:			
Part No.	OEM Ref.	Description	Image ID
SP23069-11	T20102 3359	Injection Pump Timing Pin 6mm	
SP23161-94	T10115	Tensioner Locking Pin	
SP23161-03	T10050	Crankshaft Sprocket Alignment Tool	
SP23161-03C	T10100	Crankshaft Sprocket Alignment Tool	
SP23069-12	T10008	Tensioner Locking Tool	
SP23161-96	T10060/A T20167	Auxiliary Drive Belt Tensioner Pin	

Optional Extras:

- 07756005 (3387 / T10020) - Multi-Position Tensioner Wrench
- SP23161-07 (3369) - Support Guides
- 07756006 (T10264 / T10265 / T40098) Tensioner Pulley Locking Pin Set
- 07763700 (T10172) - Sprocket Holding Tool

See pages 230 - 231 for further details

Skoda 1.9D/SDI/TDI Diesel Engine Timing Kit

07757900

D BELT

- Set of locking tools required for cam belt service
- Applications:
Skoda Felicia ('95-) Skoda Octavia ('96-)
- Engine Codes:
1.9D - AEF
1.9TDI - AGR, AHF, ALH, ASV
1.9SDI - AGP, AHF, AQM



*Components can be found in Master Kit - 077560V2
See page 147 for details*

Spare Parts:			
Part No.	OEM Ref.	Description	Image ID
SP23161-B	3418	Camshaft Aligning Tools (2)	
SP23062-B	MP-1-300	Crankshaft Aligning Tool	
SP23069-11	T20102 3359	Timing Chain Tensioner Locking Pin	
SP23061-01	2064	Pump Sprocket Locking Pin	

Skoda 1.2 / 1.6 / 2.0 Common Rail Diesel Engine Timing Kit
07757100
D BELT

- Designed to fit the newest common rail diesel engines which are significantly different from the older PD engines
These CR engines combine belt and gear drives by using a toothed belt to transfer the drive from the crankshaft to one of the cam shafts then using gears to transfer the drive from one cam to the other

- Applications:
Skoda Fabia 2 ('10-)
Skoda Octavia ('09-)
Skoda Rapid ('12-)
Skoda Roomster ('10-)
Skoda Superb ('08-)
Skoda Yeti ('09-)

- Engine Codes:
1.2D TDI - CFWA
1.6D TDI - CAYA, CAYB, CAYC
2.0D TDI - CBDB, CEGA, CFHA, CFHC, CFHF, CFJA, CLCA, CLCB, CBBB

Spare Parts:

Part No.	OEM Ref.	Description	Image ID
SP23069-11	T20102 3359	Injection Pump / Camshaft Alignment Pin	
SP23161-03	T10050	Crankshaft Pulley Locking Tool (Bored)	
SP23161-03C	T10100	Crankshaft Pulley Locking Tool (Non-bored)	
SP23161-81	T10264	Tensioner Pulley Adjustment tool (2.4mm Hex key)	
SP23161-83	T10265	Tensioner Pulley Locking Tool	
SP23161-96	T10060/A	Auxiliary Tensioner Locking Tool (3.9mm)	
SP23161-61	T10051	Sprocket Holding Tool	
SP23161-62	T10052	Cam Sprocket Hub Puller	
SP23161-17	T10255	Oil Pump / Balance Shaft Alignment	

Optional Extras:

- 07763700 (T10172) - Sprocket Holding Tool
 - 07756900 (3369 / T10093) - Guide Pin Set
- See page 230 for further details

Skoda 2.5TDI Diesel Engine Timing Kit
07757800
D BELT

- Set of locking tools required for cam belt service

- Applications:
Skoda Superb ('02-)

- Engine Codes:
2.5TDI - AYM, BDG

Spare Parts:

Part No.	OEM Ref.	Description	Image ID
SP23069-11	T20102/3359	Injection Pump Timing Pin 6mm Dia.	
SP23161-06	T40011	Tensioner Pin	
SP23056-02	3458	Camshaft Alignment Plates	
SP23161-07	3369	Support Guide	
SP23056-01	3242	Crankshaft Locking Pin	
SP23161-96	T10060/A	Auxiliary Drive Belt Tensioner Pin	

Optional Extras:

- 07752400 (3036) - Sprocket Holding Wrench
 - 07757500 (T40001) - Camshaft Sprocket Pulley Puller
- See page 230 for further details

Locking tools from kit 077560V2 - see page 147

**Suzuki 1.0 / 1.2 / Petrol Engine Timing Kit
07753200**

P CHAIN

- Set of locking tools required for correct valve timing on chain driven engines
- Applications:
Suzuki Wagon ('05-'08)
- Engine Codes:
1.0 - Z10XEP
1.2 - Z12XEP

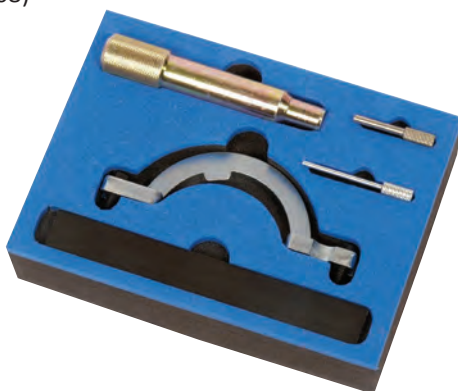

Spare Parts:			
Part No.	OEM Ref.	Description	Image ID
SP23164-11	09912-38310	Crankshaft TDC Timing Pin	
SP23164-12	09919-58310	Camshaft Setting Plate	
SP23164-14	09919-08310	Timing Disc Position Gauge	
SP23164-15	09919-58320	Tensioner Retaining Pin - 2.5mm	
SP23164-16	09919-58320	Tensioner Retaining Pin - 4.0mm	

**Suzuki 1.3D DDIS Diesel Engine Timing Kit
07761900**

D CHAIN

- Applications:
Suzuki Ignis ('03-)
Suzuki Splash ('08-)
Suzuki Swift ('04-)
Suzuki Wagon R ('03-)
- Engine Codes:
1.3 - Z13DT, D13A, Z13DTJ



Parts from kit 07751800 (see page 168)

Spare Parts:			
Part No.	OEM Ref.	Description	Image ID
SP23171-02	09917-68610	Camshaft Alignment Tool (2)	
SP23174-02	09912-38300	Flywheel Pin with Spring	
SP23069-25Z	KM613	8mm Crank Locking Pin	

**Suzuki 1.5D DDIS Diesel Engine Timing Kit
07755700**

D BELT

- Set of locking tools enabling correct valve timing
- Applications:
Suzuki Jimmy ('03-)
- Engine Codes:
1.5D DDIS - K9K 262, K9K 266, K9K 299



Spare Parts:			
Part No.	OEM Ref.	Description	Image ID
SP23054-04	MOT 1489	Crankshaft Timing Pin	
SP23069-23	MOT 1054	Timing Pin	
SP23069-25Z	MOT 1430	Crankshaft Timing Pin	

**Toyota 1.0 / 1.3 / 1.5 / 1.6 Petrol & 1.4 / 2.0 / 2.2 Diesel Engine Timing Kit
07764800**
P D CHAIN

- Applications:
 Toyota Auris ('06-)
 Toyota Avensis ('99-)
 Toyota Aygo ('05-)
 Toyota Corolla ('01-)
 Toyota Corolla Verso ('01-)
 Toyota IQ ('08-)
 Toyota Previa ('00-)
 Toyota Prius MK1/2 ('00-)
 Toyota RAV4 ('01-)
 Toyota Urban Cruiser ('08-)
 Toyota Verso ('09-)
 Toyota Yaris/Verso ('99-)
 Toyota Lexus IS ('05-)
- Engine Codes:
 1.0/VVT-I -1SZ-FE, 1KR-FE, 1SZ-FE
 1.3 - 2SZ-FE
 1.4-4D - IND-TV, 2WZ-TV
 1.5 - 1NZ-FXE
 1.6 - 1ZR-FE
 2.0D-4D - 1CD-FTV
 2.2D-4D - 2AD-FHV, 2AD-FTV

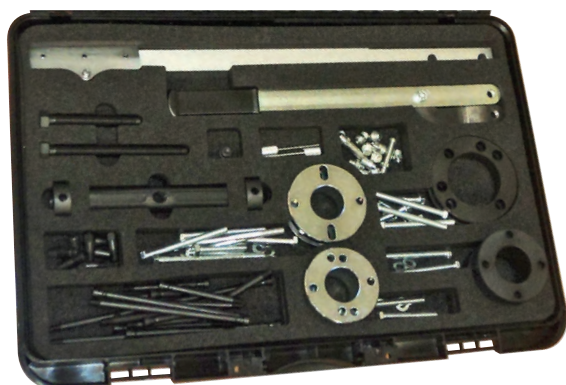

Spare Parts:			
Part No.	OEM Ref.	Description	Image ID
SP77648-01	09330-00021	Crankshaft Pulley Lock Tool	
SP77648-02	09960-10010 09962-01000 09963-01000	Camshaft Locking Tool for Camshaft Pulley	
SP77648-03	09240-00020 09242-00200	Chain Tensioner Lock Pin	
SP77648-04	09950-50012 09950-50013	Crankshaft Pulley Extractor	
SP77648-05	09240-00020 09242-00220	Chain Tensioner Locking Pin	
SP77648-06	09213-54015	Lock for Camshaft Pulley	
SP77648-07	09213-58014 09213-58013	Lock for Camshaft Pulley	
SP77648-08	09213-14010	Lock for Camshaft Pulley	
SP77648-09	09213-70011	Lock for Camshaft Pulley	

DIESEL INJECTOR SEAT CLEANER SET

CLEANS INJECTOR SEATS & CHAMBERS WHEN CHANGING OR RECONDITIONING DIESEL INJECTORS

SEE PAGE 52



Volkswagen 1.2 6v/12v - 3 Cyl. Petrol Engine Timing Kit

07756100

P

CHAIN

- Set of locking tools required for chain maintenance
- Applications:
Volkswagen Fox ('05-)
Volkswagen Polo 1V ('02-)
Volkswagen Polo V ('09-)

- Engine Codes:
1.2 - AWY, AZQ, BBM,
BMD, BME, BZG,
CGPA, CGPB,
CHFA, CHFB



Spare Parts:

Part No.	OEM Ref.	Description	Image ID
SP23176-01	T10123	Camshaft Aligning Tool (2)	
SP23176-02	T10120	Camshaft Aligning Tool	
SP23176-03	T10121	Crankshaft Locking Tool	

Optional Extras:

- 07763700 (T10172) - Sprocket Holding Tool
See page 230 for further details

Volkswagen 1.2 TSI Petrol Engine Timing Kit

07763600

P

CHAIN

- Set of locking tools required for chain maintenance
- Applications:
Volkswagen New Beetle ('11-)
Volkswagen Caddy Maxi ('10-)
Volkswagen Golf VI/Plus ('09-)
Volkswagen Jetta ('11-)
Volkswagen Polo V ('09-)
Volkswagen Touran ('10-)

- Engine Codes:
1.2TSI - CBZA, CBZB, CBZC



Spare Parts:

Part No.	OEM Ref.	Description	Image ID
SP23191-02X	T10340	Crankshaft Locking Pin	
SPE10436	T10414	Camshaft Locking Tool	

Optional Extras:

- 07763700 (T10172) - Sprocket Holding Tool
See page 230 for further details

Volkswagen 1.2 TSI / 1.4T, FSI, GTI and 1.6 FSI Petrol Engine Timing Kit

07763400

P

CHAIN

- Set of locking tools required for chain maintenance
- Applications:
Volkswagen New Beetle ('11-)
Volkswagen Caddy Maxi ('10-)
Volkswagen Eos ('06-)
Volkswagen Golf IV ('06-)
Volkswagen Golf V ('03-)
Volkswagen Golf VI/Plus ('09-)
Volkswagen Jetta ('06-)
Volkswagen Passat ('05-)
Volkswagen Polo IV ('02-)
Volkswagen Polo V ('09-)
Volkswagen Scirocco ('08-)
Volkswagen Sharan ('10-)
Volkswagen Tiguan ('07-)
Volkswagen Touran ('06-)

- Engine Codes:
1.2TSI - CBZA, CBZB, CBZC
1.4T/FSI - AXU, BKG, BLG, BLN, BMY, BWK, CAVA, CAVB, CAVC, CAVD, CAVE, CAXA, CAXC, CAXD, CAVG, CDGA, CKMA, CDGA, CTHA, CTHD, CTHE
1.6/FSI - BAG, BLP, BLF, BTS, GNKA



Spare Parts:

Part No.	OEM Ref.	Description	Image ID
SPE10436	T10414	Camshaft Locking Tool	
SP23072-A	VAS 6079	Dial Test Indicator 41 x 8mm	
SP23107-B	T10170	TDC Indicator	
SP23162-41	T10171/A	Camshaft Alignment Tool	
SP23161-06	T20046 T40011	Tensioner Pin	
SP23191-02X	T10340	Crankshaft Locking Pin	
SP23191-01	T10341	Guide Pins (2)	

Optional Extras:

- 07763700 (T10172) - Sprocket Holding Tool
See page 230 for further details

Camshaft Alignment Locking Tool
07756014
P BELT

- Locking tool required for cam belt service
- Applications:
 - Volkswagen Beetle ('01-)
 - Volkswagen Bora ('97-)
 - Volkswagen Caddy ('99-)
 - Volkswagen Caddy Max ('04-)
 - Volkswagen Golf IV ('97-)
 - Volkswagen Golf VI ('08-)
 - Volkswagen Lupo ('98-)
 - Volkswagen Polo III ('95-)
 - Volkswagen Polo IV ('02-)
 - Volkswagen Polo ('09-)

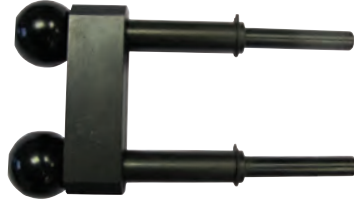

- Engine Codes:
 - 1.4 - AFK, AHW, AKQ, APE, AQQ, ARR, AUA, AUB, AXP, BBY, BBZ, BCA, BKY, BUD, CMAA, CGGA, CGGB
 - 1.6/GTI - AJV, ARC, ATN, AZD, AUS, AVY, BCB, BAD

Spare Parts:

Part No.	OEM Ref.	Description	Image ID
07756014	T10016 T10074	Camshaft Alignment Locking Tool	

Optional Extras:

- 07767100 (3415) 1.4 only - Crankshaft Pulley Holding Tool
See page 231 for further details

Tool found in kit 077560V2 - see page 147
Volkswagen 1.8, 1.8 Turbo / 2.0 Twin Camshaft Petrol Engine Timing Kit
07757200
P BELT CHAIN

- Set of tools required for belt and chain service
- Applications:
 - Volkswagen Beetle ('99-)
 - Volkswagen Bora ('98-)
 - Volkswagen Golf III ('92-'98)
 - Volkswagen Golf IV ('97-)
 - Volkswagen Passat ('97-)
 - Volkswagen Polo ('05-)
 - Volkswagen Sharan ('97-)

- Engine Codes:
 - 1.8 - ADR, AEB, AGN, AGU, AJH, ANB, APT, APU, AQA, ARG, ARZ, AUM, AUQ, AVC, AWC, AWT, AWU, BBU, BJX
 - 2.0 - ALT

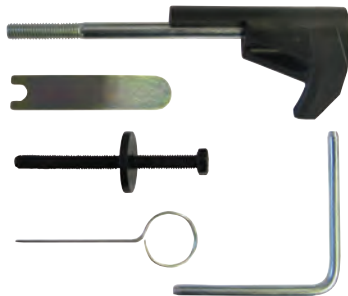
Spare Parts:

Part No.	OEM Ref.	Description	Image ID
SP23161-06	T40011 T20046	Tensioner Locking Pin	
SP23161-93	T10092	Tensioning Bolt	
SP23161-92	3366	Chain Tensioner Retainer	
SP23069-12	T10008	Tensioner Locking Tool	
SP23161-96	T10060/A	Auxiliary Drive Belt Tensioner Pin	

Camshaft Adjustment Tool for Petrol TFSI and TSI engines
07757300
P CHAIN

- Two in one tool for the removal of camshaft control valves prior to chain removal
- Applications:
 - Volkswagen New Beetle ('11-)
 - Volkswagen Golf VI ('09-)
 - Volkswagen Jetta ('08-)
 - Volkswagen Passat ('07-)
 - Volkswagen Passat CC ('08-)
 - Volkswagen Scirocco ('08-)
 - Volkswagen Eos ('08-)
 - Volkswagen Sharan ('11-)
 - Volkswagen Tiguan ('07-)
- Engine Codes:
 - 1.8 - BZB, CDAA, CDAB, CGYA
 - 2.0 - CAWA, CAWB, CBFA, CCTA, CCZA, CCZB, CCZC, CCZD

- OEM Reference: T10352/1 and T10352



Volkswagen 2.0FSI / TFSI / GTI Petrol Engine Timing Kit
07756700

P **BELT** **CHAIN**

- Set of tools required for belt and chain service
- Applications:
 Volkswagen Eos ('06-) Volkswagen Passat ('05-)
 Volkswagen Golf V ('04-) Volkswagen Touran ('03-)
 Volkswagen Jetta ('05-)

- Engine Codes:
 2.0 FSI - AXW, BLR, BLX, BLY, BVX, BVY, BVZ
 2.0 TFSI - AXX, BPY, BWA
 2.0 GTI - AXX, BPY, BWA, BYD



Locking tools also suitable for Scirocco ('09-), Golf VI 2.0R with engine codes CDLA, CDLC, CDLF

Spare Parts:			
Part No.	OEM Ref.	Description	Image ID
SP23044-04	T10020	Tension Wrench	
SP23161-06	T40011	Tensioner Locking Pin	
SP23161-91	T10252	Camshaft Alignment Tool	
SP23161-92	3366	Chain Tensioner Retainer	
SP23161-93	T10092	Chain Tensioner Retaining Screw & Nut	
SP23161-96	T10060/A	Auxiliary Drive Belt Tensioner Pin	
Optional Extras:			
<ul style="list-style-type: none"> • 07756900 (3369) - Guide Pin Set See page 230 for further details			

Volkswagen 2.8 V6 Petrol Engine Timing Kit
07757400

P **BELT**

- Set of locking tools required for cam belt service
- Applications:
 Volkswagen Passat ('96-'05)
- Engine Codes:
 2.8 V6 - ACK, AGE, ALG, AMX, APR, AQD, ATX, BBG



Spare Parts:			
Part No.	OEM Ref.	Description	Image ID
SP23056-01	3242	Crankshaft Locking Pin	
SP23056-B	3391	Twin Cam Locking Strap	
Optional Extras:			
<ul style="list-style-type: none"> • 07757500 (T40001) - Camshaft Sprocket Pulley Puller for V6 / V8 engines • 07756900 (3369) - Guide Pin Set for Audi A4 / A6 • 07752400 (3036) - Sprocket Holding Wrench • SP23161-92 (3366) - Chain Tensioner Retainer See pages 230 - 231 for further details			

Volkswagen 1.7SDI, 1.9D/SDI/TDI Diesel Engine Timing Kit
07757900

D **BELT**

- Set of locking tools required for cam belt service
- Applications:
 Volkswagen Beetle / Bora ('98-) Volkswagen Lupo ('98-)
 Volkswagen Caddy / Passat ('96-) Volkswagen Polo III ('95-)
 Volkswagen Golf III ('94-) Volkswagen Sharan ('95-)
 Volkswagen Golf IV ('97-) Volkswagen Vento ('93-)

- Engine Codes:
 1.7D/SDI - AHB, AHG, AKU, AKW
 1.9D - 1Y, AEF, AEY
 1.9TD - AAZ
 1.9TDI - 1Z, AFN, AGR, AHF, AHH, AHU, ALE, ALH, ASV, AVG
 1.9SDI - AEY, AGD, AGP, AQM, ASX, AYQ



Components can be found in Master Kit - 077560V2. See page 147 for details

Spare Parts:			
Part No.	OEM Ref.	Description	Image ID
SP23161-B	3418	Camshaft Aligning / Locking Tool	
SP23062-B	2065A	Camshaft Setting Bar	
SP23069-11	3359	Injection Pump Locking Pin	
SP23061-01	2064	Pump Sprocket Locking Pin	
Optional Extras:			
<ul style="list-style-type: none"> • 07756005 (T10020 / V159) - Multi-Position Tensioner Wrench • 07752400 (3036) - Sprocket Holding Wrench • SP23161-07 (3369) - Support Guides See pages 230 - 231 for further details			

Volkswagen 1.2 - 2.0 TDI PD Diesel Engine Timing Kit
077562V2
D BELT

- Set of locking tools required for cam belt service
- Applications:

Volkswagen Beetle ('01-)	Volkswagen Lupo ('99-)
Volkswagen Bora ('98-)	Volkswagen Passat ('98-)
Volkswagen Caddy Maxi ('04-)	Volkswagen Polo III ('99-)
Volkswagen Eos ('06-)	Volkswagen Polo IV ('02-)
Volkswagen Fox ('05-)	Volkswagen Sharan ('99-)
Volkswagen Golf IV ('99-)	Volkswagen Touran ('03-)
Volkswagen Golf V ('03-)	Volkswagen Transporter T5 ('03-)
Volkswagen Jetta ('05-)	
- Engine Codes:

1.2TDI PD - ANY, AYZ
1.4TDI PD - AMF, BAY, BNM, BNV, BMS, BWB
1.9TDI PD - AJM, ANU, ARL, ASZ, ATD, ATJ, AUJ, AVB, AVF, AVQ, AWW, AXB, AXC, AXR, BJB, BKC, BLS, BLT, BMT, BRM, BRR, BRS, BRU, BSU, BSW, BTB, BVH, BVK, BXE, BXF, BXJ
2.0TDI PD - AZV, BGW, BHW, BKD, BKP, BMA, BMM, BMN, BMP, BMR, BRT, BUZ, BVE, BWV
2.0SDI - BDJ, BDK, BST



Components can be found in
Master Kit - 077560V2
See page 147 for details

Spare Parts:			
Part No.	OEM Ref.	Description	Image ID
SP23069-11	T20102 3359	Injection Pump Timing Pin 6mm Dia.	
SP23161-94	T10115	Tensioner Locking Pin	
SP23161-03	T10050	Crankshaft Sprocket Alignment Tool	
SP23161-03C	T10100	Crankshaft Sprocket Alignment Tool	
SP23069-12	T10008	Tensioner Locking Tool	
SP23161-96	T10060/A T20167	Auxiliary Drive Belt Tensioner Pin	
Optional Extras:			
<ul style="list-style-type: none"> • 07756005 (3387 / T10020) - Multi-Position Tensioner Wrench • SP23161-07 (3369) - Support Guides • 07756006 (T10264 / T10265 / T40098) Tensioner Pulley Locking Pin Set • 07763700 (T10172) - Sprocket Holding Tool See pages 230 - 231 for further details			

Volkswagen 1.2 / 1.6 / 2.0 Common Rail Diesel Engine Timing Kit
07757100
D BELT

- Designed to fit the newest common rail diesel engines which are significantly different from the older PD engines
- Applications:

Volkswagen Amarok ('10-)	Volkswagen Passat CC ('08-)
Volkswagen Caddy Maxi ('10-)	Volkswagen Polo V ('09-)
Volkswagen Crafter ('11-)	Volkswagen Scirocco ('08-)
Volkswagen Eos ('08-)	Volkswagen Sharan ('10-)
Volkswagen Golf VI ('09-)	Volkswagen Tiguan ('07-)
Volkswagen Golf Plus ('09-)	Volkswagen Touran ('10-)
Volkswagen Jetta ('09-)	Volkswagen Transporter T5 ('09-)
Volkswagen Passat ('08-)	
- Engine Codes:

1.2D TDI CR - CFWA
1.6D TDI CR - CAYB, CAYC, CAYD, CAYE, CLNA
2.0D TDI CR - CAAA, CAAB, CAAC, CBAA, CBAB, CBAC, CBBA, CBBB, CBDA, CBDB, CBDC, CCHA, CDBA, CDCA, CEGA, CFCA, CFFA, CFFB, CFFD, CFFE, CFGB, CFHB, CFHC, CFHE, CFHF, CFJA, CJAA, CKTB, CKTC, CKUB, CKUC, CLCA, CLJA, CLLA



Spare Parts:			
Part No.	OEM Ref.	Description	Image ID
SP23069-11	T20102 3359	Injection Pump / Camshaft Alignment Pin	
SP23161-03	T10050	Crankshaft Pulley Locking Tool (Bored)	
SP23161-03C	T10100	Crankshaft Pulley Locking Tool (Non-bored)	
SP23161-81	T10264	Tensioner Pulley Adjustment tool (2.4mm Hex key)	
SP23161-83	T10265	Tensioner Pulley Locking Tool	
SP23161-96	T10060/A	Auxiliary Tensioner Locking Tool (3.9mm)	
SP23161-61	T10051	Sprocket Holding Tool	
SP23161-62	T10052	Cam Sprocket Hub Puller	
SP23161-17	T10255	Oil Pump / Balance Shaft Alignment	
Optional Extras:			
<ul style="list-style-type: none"> • 07763700 (T10172) - Sprocket Holding Tool • 07756900 (3369 / T10093) - Guide Pin Set See page 230 for further details			

Volkswagen 2.4 / 2.5 Diesel Engine Timing Kit 077564V2

D

BELT

- Set of locking tools required for cam belt service
- Applications:
Volkswagen Crafter ('06-)
Volkswagen LT ('96-)
Volkswagen Transporter T4 ('95-)
- Engine Codes:
2.5TDI - BJJ, BJK, BJL, BJM, CEBA, CEBB, CECA, CECB
2.4D / 2.5SDI / TDI - AAB, AJA, ACV, AHY, AJT, AUF, AXG,
AYC, AXL, AYY



Spare Parts:

Part No.	OEM Ref.	Description	Image ID
SP23061-01	2064	Injection Pump Sprocket Locking Pin Ø15.4 mm	
SP23062-B	2065A	Camshaft Setting Bar	
SP23060-F	Shim Set	Shim Set (2)	
SP23161-71	T10025	Crankshaft Damper Holding Tool	
SP23161-15	T50009	Crankshaft Timing Pin (Crafter only)	
SP23161-16	3355	Pulley Wrench	

Optional Extras:

- 07752400 (3036) - Sprocket Holding Wrench
 - 07757500 (T40001) - Camshaft Sprocket Pulley Puller
- See pages 229 - 230 for further details

Volkswagen 3.0 / 4.2 TDI Diesel Engine Timing Kit 07757700

D

CHAIN

- Set of locking tools required for correct valve timing on chain driven engines
- Applications:
Volkswagen Phaeton ('04-)
Volkswagen Touareg ('03-)
- Engine Codes:
3.0TDI - BKS, BMK, BUN, CARA, CASA, CASB, CASC, CASD,
CATA, CEXA
4.2TDI - CKDA



Spare Parts:

Part No.	OEM Ref.	Description	Image ID
SP23056-01	3242	Crankshaft Locking Pin	
SP23069-11	3359	Injection Pump / Balancer Shaft Locking Pin	
SP23161-21Z	T40049	Crankshaft Turning Tool - Type 2	
SP23161-95	T40058	Crankshaft Turning Tool - Type 1	
SP23161-22	T40060	Camshaft Locking Pin (2)	
SP23161-23Z	T40061	Camshaft Alignment / Locking Tool	
SP23161-24Z	T40062	Camshaft Sprocket Holding Tool	
SP23161-25	3.3mm Pins	Tensioning Locking Pin (2)	

Optional Extras:

- SP23162-63 - (T40071) Timing Chain Tensioner Locking Pin
 - 07752400 (3036) - Sprocket Holding Wrench
- See pages 230 - 231 for further details

Volkswagen 2.5TDI Diesel Engine Timing Kit 07757800

D BELT

- Set of locking tools required for cam belt service
- Applications:
Volkswagen Passat ('98-'05)
- Engine Codes:
2.5TDI - AFB, AKN, BAU, BDG, BDH



Locking tools from kit 077560V2 - see page 147

Spare Parts:

Part No.	OEM Ref.	Description	Image ID
SP23069-11	T20102/3359	Injection Pump Timing Pin 6mm Dia.	
SP23161-06	T40011	Tensioner Pin	
SP23056-02	3458	Camshaft Alignment Plates	
SP23161-07	3369	Support Guide	
SP23056-01	3242	Crankshaft Locking Pin	
SP23161-96	T10060/A	Auxiliary Drive Belt Tensioner Pin	

Optional Extras:

- 07752400 (3036) - Sprocket Holding Wrench
 - 07757500 (T40001) - Camshaft Sprocket Pulley Puller
- See page 230 for further details

Volkswagen 2.5 TDi PD Diesel Engine Timing Kit 07757600

D

- Designed for gear driven engines
- Applications:
Volkswagen Transporter/ Multivan T5 ('03-)
Volkswagen Touareg ('03-)
- Engine Codes:
2.5 TDi PD - AXD, AXE, BAC, BLJ, BLK, BNZ, BPC, BPD, BPE

Spare Parts:

Part No.	OEM Ref.	Description	Image ID
SP23270-01	T10193	Camshaft Locking Tool Type 1	
SP23270-04	T10199	Camshaft Gear Retaining Tool Type 1	
SP23270-05	T10199/1	Camshaft Gear Retaining Tool Type 2	
SP23162-82	T10225	Crankshaft Turning Tool	
SP23270-07	T10226	Crankshaft Alignment Tool	
SP23270-08	T10234	Camshaft Gear Pre-tensioning Tool	

Crankshaft Pulley Holding Tool

07764100

P D

• Applications:

- | | | |
|------------------|------------------|-------------------|
| Volvo C30 ('06-) | Volvo S80 ('98-) | Volvo XC60 ('08-) |
| Volvo C70 ('97-) | Volvo V40 ('97-) | Volvo XC70 ('02-) |
| Volvo S40 ('97-) | Volvo V50 ('04-) | Volvo XC90 ('02-) |
| Volvo S60 ('00-) | Volvo V60 ('10-) | |
| Volvo S70 ('97-) | Volvo V70 ('96-) | |

• Engine Codes:

- | | |
|------------------------|---|
| 1.6 - B4164S | 2.4 - B5244S/2/4/5/7 SG/2 |
| 1.8 - B4184S | 2.4T - B5244T/2/3/4/5/7 |
| 1.9 - B4194T | 2.5 - B5254FS/T2/3/4/5/6/7/8/10/11 |
| 2.0T 16v - B4204S/T | 2.9 - B6284T/2, B6294S/2, B6304S3, B6294T |
| 2.0T - B5204T3/4/5 | 2.0D - D5204T/2/3/5 |
| 2.3 - B5234FS/T3/7/8/9 | 2.4D - D5244T/2/3/4/5/6/7/8/9/10/11/13/14/15/16 /17/18/19 |

• OEM Reference: 999-5433

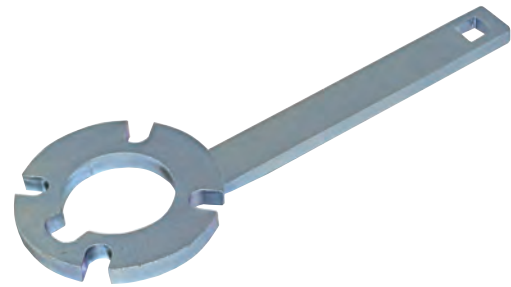

Volvo 1.6 / 1.8 / 2.0 Petrol Engine Timing Kit

077523V2

P BELT CHAIN

• Set of tools required for belt and chain service

• Applications:

- | | |
|------------------|------------------|
| Volvo C30 ('06-) | Volvo V50 ('04-) |
| Volvo S40 ('04-) | Volvo V70 ('07-) |
| Volvo S80 ('07-) | |

• Engine Codes:

- 1.6 - B4164S3 (Belt)
 1.8 - B4184S8/11 (Chain)
 2.0 - B4204S3/4 (Chain)



Spare Parts:

Part No.	OEM Ref.	Description	Image ID
SP23054-02X	999-7152	Crankshaft Timing Pin	
SP23054-05	999-7406	Crankshaft Timing Pin	
SP23054-03	999-7201	Crankshaft Timing Pin	
SP23054-06	999-7151	Camshaft Alignment Bar	
SP23161-94	N/A	Tensioner Locking Pin	

Tools from kit 07752600 - See page 171

Volvo Petrol Engine Timing Kit

07755600

P BELT

• Set of locking tools required for engine overhaul work

• Applications:

- | | |
|------------------|-------------------|
| Volvo C70 ('97-) | Volvo V40 ('96-) |
| Volvo S40 ('96-) | Volvo V70 ('97-) |
| Volvo S60 ('00-) | Volvo XC70 ('02-) |
| Volvo S70 ('97-) | Volvo XC90 ('02-) |
| Volvo S80 ('98-) | |

• Engine Codes:

- 1.6 - B4164S/2
 1.8 - B4184S/2/3/9/10
 1.9T - B4194T/2
 2.0 - B4204S/2/T/2/3/5
 2.0i - B5202FS
 2.0T - B5204T2/3/4/5
 2.3T - B5234FS/T3/4/6/7/8/9
 2.4/T - B5244S/S2/SG/SG2/T/3/4/5/7
 2.5T 10v - B5252FS
 2.5R/T - B5254/T/2/4



Spare Parts:

Part No.	OEM Ref.	Description	Image ID
SP23054-03	999-7201	Crankshaft Timing Pin	
SP23054-06	999-7151	Camshaft Alignment Bar	
SP23069-41	999-5451 MOT 1340	Crankshaft Timing Pin	
SP23069-45	MOT 1348	Tensioning Tool (Auxiliary Drive Belt)	
SP23069-47	999-5452 MOT 1337	Camshaft Setting Tool	

Note: 07764100 kit may be required - See above

Also used on Renault Engines - 2.0 16v (N7Q704/710/711) and 2.5 20v (N7U700/701)

Volvo 1.6D Diesel Engine Timing Kit

07763900
D **BELT**

- A set of timing pins required for belt renewal

- Applications:

Volvo C30 ('06-)
Volvo S40 ('04-)
Volvo S60 ('11-)
Volvo S80 ('09-)

Volvo V50 ('04-)
Volvo V60 ('11-)
Volvo V70 ('09-)



- Engine Code:
1.6D/D2/Drive -
D4162T, D4164T

Spare Parts:

Part No.	OEM Ref.	Description	Image ID
SP23060-11	0194C 999-7121 21-262 303-734	Flywheel Locking Pin	
SP23069-04	0194A 21-260 303-732 999-7169	Camshaft / Fuel Pump Alignment Tool	
SP23060-25Z	0194B 21-263 303-735 999-7122	Camshaft Sprocket Locking Tool	

Parts from kit 07752200 and 07753600 (see page 178)

Volvo 2.0D Diesel Engine Timing Kit

07752800
D **BELT**

- Set of locking tools required for cam belt service

- Applications:

Volvo C30 ('06-)
Volvo C70 ('07-)
Volvo S40 ('04-)
Volvo S80 ('07-)
Volvo V50 ('04-)
Volvo V70 ('07-)



- Engine Codes:
2.0D - D4204T/2

Spare Parts:

Part No.	OEM Ref.	Description	Image ID
SP23069-25Z	999-7122	Camshaft Pulley Timing Pin	
SP23069-57	999-7121	Flywheel Locking Timing Pin	
SP23060-10	999-7119 999-7120	Flywheel / Ring Gear Locking Tool Adaptor	



**FOR THE LATEST
PRODUCT INFORMATION
VISIT OUR NEW WEBSITE:**

www.sykes-pickavant.com

Diesel Injection Fuel Pump Timing Kit

07757000

- For Bosch Rotary and Lucas, CAV Rotodiesel DPC Rotary Injection Pumps – Top Entry
- Includes a special Top Dead Centre indicator for the Peugeot XUD engine range
- This set includes special purpose adaptors and extensions complete with an interchangeable Dial Test Indicator which measures up to 8mm with increments of 0.01 mm
- Adjustable bezel for zeroing and limit tabs
- Applications:
 Diesel Bosch EP & VE Rotary
 CAV Rotodiesel
 Peugeot XUD
 Nippon
 Denso
 Kikki



Application	07757000										
	SP23065-01	SP23065-03	SP23065-05	SP23066-01	SP23066-03	SP23072	SP23076-01	SP23076-02	SP23067-02	SP23067-10	SP23077-01
Alfa Romeo	✓	✓				✓	✓	✓			
Audi	✓	✓				✓	✓	✓			✓
Bedford	✓	✓	✓			✓					
BMW	✓	✓				✓	✓	✓			
Citroën				✓	✓	✓			✓	✓	
Dacia						✓			✓	✓	
Daihatsu	✓	✓				✓					
Fiat	✓	✓				✓	✓	✓	✓	✓	
Ford	✓	✓				✓	✓	✓	✓	✓	✓
Isuzu	✓	✓				✓	✓	✓			
Iveco	✓	✓				✓	✓	✓			
Lancia	✓	✓				✓	✓	✓			
Land Rover	✓	✓				✓	✓	✓			
Leyland / Daf						✓			✓	✓	
Mazda	✓	✓				✓	✓	✓			
Mitsubishi	✓	✓				✓	✓	✓			
Nissan	✓	✓				✓	✓	✓			
Opel						✓			✓	✓	
Peugeot				✓	✓	✓			✓	✓	
Renault	✓	✓				✓	✓	✓	✓	✓	✓
Rover	✓	✓				✓	✓	✓	✓	✓	
Seat	✓	✓				✓	✓	✓			
Volkswagen	✓	✓				✓	✓	✓			✓
Volvo	✓	✓				✓	✓	✓			

Spare Parts:

Part No.	Description	Image ID
SP23065-01	M8 Adaptor - Long	
SP23065-03	Extension - Long 99mm	
SP23065-05	Thread Converter M8-M12	
SP23066-01	Piston Height Adaptor M14	
SP23066-03	Extension	
SP23067-02	Probe	
SP23067-10	Mounting Bracket Assembly	
SP23072	Dial Test Indicator	
SP23076-01	M8 Adaptor - Short	
SP23076-02	Extension - Short 40.8mm	
SP23077-01	M10 Adaptor - Short	

Balancer Shaft Belt Tensioning Tool

SP23169-01

- OEM Reference:
1.822.149.000
1.822.154.000



TDC Indicator Extension

SP23107-B

- For use with DTI Gauge (07712000 - below) to find TDC
- OEM Reference:
1.895.443.000
1.825.013.000



Dial Test Indicator (DTI) Gauge

07712000

- For use with TDC Indicator Extension (SP23107-B - above) to find TDC
- 41mm diameter face 0.01mm increments
- Range: 0-8mm



Universal Sprocket Holding Wrench

07752400

- A multi-application wrench with variable adjustment
- Ideal for holding the sprocket whilst releasing and tightening the fastener which retains the sprocket
- OEM Reference:
1.822.146.000
1.842.128.000
1.860.831.000



Timing Belt Tensioner

SP23109

- Suitable for V6 24v engines
- Applications:
156, 166 - 2.5 / 3.0 V6 24v ('97-'02)
GTV 2.0 V6 24v ('97-'02)
- Engine codes:
161-02, 324.05, 362.01,
161.02, 342-01, 343-01, 932A.000
- OEM Reference:
1.860.950.000



Balancer Shaft Belt Tensioning Tool

SP23169-02

- OEM Reference:
1.860.845.000



Flywheel Holding Tool

SP23111-06Z

- OEM Reference:
1.860.898.000



BMW Chain Service Tool Kit

07763800

P

CHAIN

- Applications: BMW 1.8 / 2.0 / 2.5 / 3.0
BMW 116 (E811, E87) ('03-'08)
BMW 118 (E87) ('04-'07)
BMW 120 (E87) ('04-'07)
BMW Valvetronic 128i (E82) ('07-'08)
BMW 316 (E46) ('01-'05)
BMW 316ti Compact (E46) ('01-'05)
BMW 318i (E46) ('01-'07)
BMW 316 (E46, E90) ('01-'08)
BMW 316Ci (E46) ('01-'06)
BMW 316ti (E46) ('01-'05)
BMW 318 Compact (E46) ('01-'05)
BMW 318i (E90) ('05-'08)
BMW 320 (E90) ('05-'08)
BMW Direct Injection Non-Valvetronic 323i (E90, E911, E92, E93) ('04-'08)
BMW 325 (E90, E911, E92, E93) ('04-'08)
BMW 328 (E90, E911, E92, E93) ('04-'08)
BMW 330 (E90, E911, E92, E93) ('04-'08)
BMW 335 (E90, E911, E92, E93) ('05-'08)
BMW Z4 2.0 (E85) ('04-'08)
BMW Z4 2.5/3.0 (E85, E86) ('05-'08)
BMW X3 2.0 (E83) ('05-'08)
BMW X3 2.5/3.0 (E83) ('06-'08)
BMW X5 3.0 (E70) ('06-'08)
BMW 130 (E811, E87) ('05-'08)
BMW 135 (E82) ('07-'08)
BMW 520 (E60) ('04-'08)
BMW 523 (E60, E61) ('04-'08)
BMW 525 (E60, E61) ('04-'08)
BMW 528 (E60, E61) ('06-'08)
BMW 530 (E60, E61) ('05-'08)
BMW 535 (E601, E61) ('06-'08)
BMW 630 (E63, E64) ('04-'08)
BMW 730 (E65, E66) ('04-'08)



Engine Codes:

N40 / N45 / N45T B16
N42 / N46 B18, B18A, B20, B20A, B20B,
N51 / N52 / N52K / N53 / N54 Valvetronic
N53 / N54 Direct Injection Non-Valvetronic

- OEM Reference: 11 4 360, 11 5 140, 11 9 280, 11 9 330

Diesel Engine Injection Pump Remover and Sprocket Retainer

07758500

- Suitable for the safe removal of the fuel pump when removing from the pump sprocket and to retain the position of the pump sprocket in-situ, whilst the pump is being removed and off the engine
- Applications:
BMW 318d Compact (E46) 320d/td Compact (E46) 330d (E46)
BMW 525d (E39, E60, E61) 530d (E39, E60, E61) 535d (E60, E61)
BMW 730d (E38)
BMW X5 3.0d (E53)



Timing Chain Pre-Tensioning Tool

SP23048-14

- OEM Reference: 119 340, 119 341, 119 342



Ford Transit Fuel Injection Pump Puller

07762400

- Special tool designed for use on Ford Transit 2.0, 2.2, 2.4 diesel engines ('11-)
- Allows the diesel injection pump to be pushed out of the pump sprocket without having to remove the timing chain
- Puller includes hooked legs to allow removal of the sprocket
- OEM Reference: 303-249 / 303-249-01

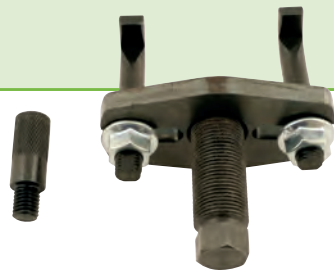

Ford Diesel Fuel Pump Sprocket Holder & Pump Cover Tool

07762500

- Optional Extra for 07762400 (above) for removal of the fuel pump cover & sprocket
- For Ford Transit 2.0, 2.2, 2.4, diesel engines, plus most other Ford Diesel apps
- OEM Reference: 303-679A



Ford Engine Crankshaft Holding Tool – Duratorq Engines

07752900

- Special tool to stop the crankshaft rotating when releasing and tightening the crankshaft pulley fasteners
- The special profile fits over the bolt heads and permits the use of a long reach socket
- Suitable for use on Ford Mondeo and Transit models with 2.0, 2.4 and 3.2 Duratorq TDCi diesel engines (01-)
- OEM Reference: 303-1310



Universal Sprocket Holding Wrench

07752400

- A multi-application wrench with variable adjustment
- Ideal for holding the sprocket whilst releasing and tightening the fastener which retains the sprocket
- OEM Reference: 205-072



Viscous Fan Holding Wrench

SP23060-70

- 1/2" diameter wrench required to remove and install the viscous fan rotor as fitted to Ford Transit models ('01-'06)
- OEM Reference: 303-1196

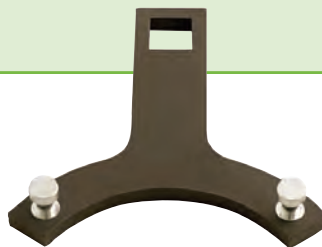

Guide Pin Set

07756900

- Enables front section of the car to be slid forward, to provide more space for servicing functions
- OEM Reference: 3369 / 3411



Support Guides

SP23161-07

- Enables front section of the car to be slid forward, to provide more space for servicing functions
- OEM Reference: 3369



Part of kit 07756900 (left)

Camshaft Sprocket Pulley Puller

07757500

- Special tool designed for use on VW Group models with V6 and V8 engines (1996 – 2007)
- Suitable for both petrol & diesel applications
- Fits applications with either 5 spoke or 6 spoke camshaft pulleys
- The three types of pulling arms will fit any number of spokes on the camshaft sprocket
- For even numbers of spokes, use either the wide or narrow legs as appropriate
- For odd numbers of spokes, use the wide and narrow legs in combination, as appropriate
- 17mm Hex headed screw – ball ended to protect the camshaft sprocket
- OEM Reference: T40001

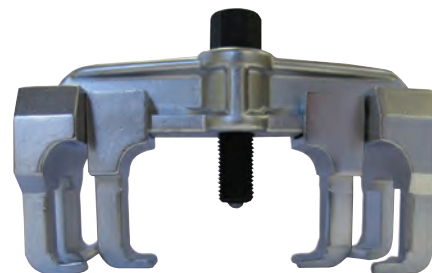

Universal Sprocket Holding Wrench

07752400

- A multi-application wrench with variable adjustment
- Ideal for holding the sprocket whilst releasing and tightening the fastener which retains the sprocket
- OEM Reference: 3036



VW Group Tensioner Pulley Locking Pin Set

07756006

- For use on Volkswagen 1.9 / 2.0 TDi PD, SOHC, 4 cylinder diesel engines where there is restricted access to the tensioner pulley rollers due to the modified sub-frame mountings introduced in 2004
- Necessary during timing belt replacement
- Applicable to models Eos, Golf, Jetta, Passat, Touran, Sharan and Caddy
- OEM Reference: T10264, T10265, T40098



Sprocket Holding Tool

07763700

- Adjustable from 40mm to 220mm plus
- Includes 4 x pair of pins ranging from 6mm to 16mm in diameter
- OEM Reference: T10172





Chain Tensioner Retainer

SP23161-92

- OEM Reference: 3366



Crankshaft Turning Tool

SP23161-95

- Commonly used on large Audi engines
- OEM Reference: T40058



Crankshaft Turning Tool

SP23161-21Z

- OEM Reference: T40049



Timing Chain Tensioner Locking Pin

SP23162-63

- OEM Reference: T40071



Crankshaft Pulley Holding Tool

07767100

- Commonly used on 1.4 & 1.6 16v Audi, Skoda and VW engines
- OEM Reference: 3415



Multi-Position Tensioner Wrench

07756005

- Five adjustable positions for ease of access
- Retains the tensioner to allow for tightening of the tensioner nut
- Suitable for both petrol and diesel applications
- Requires a 4mm Hex Key to adjust the positioning
- OEM Reference: T10020 / V159



Waterpump Pulley Puller

07756081

- For VW Touareg 2003- and Transporter 2004- with 5 cylinder diesel engine
- OEM Reference: T10221



Waterpump Remover

07756086

- For VW Transporter 2004-
- OEM Reference: T10222A



TDC Setting Wrench

07756082

- For VW Touareg 2003- and Transporter 2004- with 5 cylinder diesel engine
- OEM Reference: T10225



MODEL	YEAR	ENGINE CODE	ENGINE SIZE	PART NO.	PAGE NO.
ALFA ROMEO					
145/146	96-01	335.03	1.4 TS 16V	SP23110-C	139
145/146	96-01	676.01	1.6 TS 16V	SP23110-M	139
145/146	96-01	322.01, 671.06	1.8 TS 16V	SP23110-B	139
145/146	98-01	323.02	1.9 JTD 16V	07751700	140
145/146	96-01	323.01, 672.04	2.0 TS 16V	SP23110-B	139
147	00-11	321.03/04	1.6 TS 16V	SP23110-M	139
147	00-11	372.03	1.6 TS 16V 105	SP23110-K	139
147	00-	182B9.000, 371.01, 937A2/A3.000	1.9 JTD	07751700	140
147	02-04	192A5.000	1.9 JTD 16V	07751700	140
147	04-	937A4/5.000	1.9 JTD/M 16V	07751700	140
147	00-	323.10	2.0 TS 16V	SP23110-B	139
155/156	96-01	676.01	1.6 TS 16V	SP23110-M	139
155	96-97	671.06	1.8 TS 16V	SP23110-B	139
155	95-97	672.04	2.0 TS 16V	SP23110-B	139
156	00-06	321.02/03/04	1.6 TS 16V	SP23110-M	139
156	97-06	322.01/05	1.8 TS 16V	SP23110-B	139
156	97-02	323.02, 371.01	1.9 JTD	07751700	140
156	02-06	182B9.000, 937A2.000	1.9 JTD	07751700	140
156	02-06	192A5/B1.000, 937A4/A5.000	1.9 JTD 16V	07751700	140
156	97-02	323.01/10	2.0 TS 16V	SP23110-B	139
156	02-06	937A1/A2.000	2.0 JTS	SP23110-N	139
156	97-06	325.01, 839A6.000, 841C/G/M.000	2.4 JTD 10V	07751700	140
156	97-06	324.01/05	2.5 V6	SP23110-A	139
159	07-	939A4.000	1.8MPI	07753900	138
159	05-	939A1/A7.000	1.9 JTDM 8V	07751700	140
159	05-	939A2/A8.000	1.9 JTDM 16V	07751700	140
159	09-	939B3/B4.000	2.0 JTDM	07751700	140
159	05-	939A3/B4.000	2.4 JTDM 20V	07751700	140
166	98-07	341.03, 363.01	2.0 TS 16V	SP23110-B	139
166	00-08	342/62.02, 839A6.000, 841C/G/M.000	2.4 JTD	07751700	140
166	99-05	342/62.01	2.5 V6 24V	SP23110-A	139
166	99-07	343.01, 361.01	3.0 V6 24V	SP23110-A	139
BRERA	09-	844A2.000, 939B3.000	2.0 JTDM	07751700	140
BRERA	05-	939A3/A9.000	2.4 JTD 20V	07751700	140
CROSSWAGON	04-	937A5.000	1.9 JTD 16V	07751700	140
GIULIETTA	10-	198A4.000	1.4T 16V	07763300	138
GIULIETTA	10-	940A2000	1.4 MULTIAIR	07763200	138
GIULIETTA	10-	940A3000	1.6 JTDM	07751700	140
GIULIETTA	10-	940A4/A5000	2.0 JTDM	07751700	140
GT	05-07	322.05	1.8 TS 16V	SP23110-B	139
GT	04-	937A5.000	1.9D JTD 16V	07751700	140
GT/GTV	04-	932A2/937A1.000	2.0 JTS	SP23110-N	139
GTV	96-01	162.01	2.0 16V	SP23110-B	139
GTV	98-03	323.01/10	2.0 TS 16V	SP23110-B	139
GTV	96-04	161.02/05	3.0 V6 24V	SP23110-A	139
MITO	08-	199A3/B1/B4.000	1.3 JTDM 16V	07751800	140
MITO	08-	199A6/955A1.000	1.4 16V	07763300	138
MITO	08-	940A2.000, 955A2/A6/A7/A8.000	1.4 MULTIAIR	07763200	138
MITO	08-	198A1/A4.000, 199A8000	1.4 T-JET	07763300	138
MITO	08-	955A3/A4.000	1.6 JTDM 16V	07751700	140
SPIDER	98-01	322.01	1.8L	SP23110-B	139
SPIDER	96-01	162.01	2.0 16V	SP23110-B	139
SPIDER	98-03	323.01/10	2.0 TS 16V	SP23110-B	139
SPIDER	03-05	937A1.000	2.0 JTS	SP23110-N	139
SPIDER	09-	844A2/939B3.000	2.0 JTDM	07751700	140
SPIDER	06-	939A3/A9.000	2.4 JTDM 20V	07751700	140
SPIDER	01-04	161.05	3.0 24V	SP23110-A	139

MODEL	YEAR	ENGINE CODE	ENGINE SIZE	PART NO.	PAGE NO.
AUDI					
A1	10-	CBZA	1.2 TFSI	07763600	141
A1	10-	CAVG, CAXA	1.4 TFSI	07763400	141
A1	10-	CAYB, CAYC	1.6 TDI CR	07757100	145
A1	10-	CFHB, CFHD	2.0D TDI CR	07757100	145
A2	00-05	ANY	1.2 TDI PD	077562V2	144
A2	00-05	AMF, ATL, BHC	1.4 TDI PD	077562V2	144
A2	00-05	AUA, BBY	1.4	07756014	141
A2	02-05	BAD	1.6 FSI	07756014	141
A3	96-	AEH, AKL, APF, AVU, BFQ	1.6	07756005	231
A3	96-03	AGN, APG	1.8	07757200	142
A3	96-	AGU, AJQ, APP, AQA, ARX, ARY, ARZ, AUM, AUQ	1.8T	07757200	142
A3	96-03	AGR, AHF, ALH, ASV	1.9 TDI	07757900	145
A3	01-03	ASZ, ATD, AXR	1.9 TDI PD	077562V2	144
A3	10-	CBZB	1.2 TSI	07763600	141
A3	07-	CAXC	1.4TFSI	07763400	141
A3	03-	BGU, BSE, BSF	1.6	07756005	231
A3	04-	BAG, BLF, BLP	1.6 FSI 16V	07763400	141
A3	09-	CAYB, CAYC	1.6TDI CR	07757100	145
A3	07-	BYT, BZB, CDAA	1.8 TFSI	07757300	142
A3	04-	BKC, BLS, BXE	1.9 TDI PD	077562V2	144
A3	05-	AXW, BLR, BLX, BLY, BMB, BVY, BVZ	2.0 FSI	07756700	142
A3	05-	AXX, BPY, BWA	2.0 TFSI 16V	07756700	142
A3	07-	CAWB, CBFA, CCTA, CCZA	2.0 TFSI 16V	07757300	142
A3	03-	AZV, BKD, BMM, BMN, BUY	2.0 TDI PD	077562V2	144
A3	08-	CBAA/B, CBBB, CFFA/B, CFCB	2.0D TDI CR	07757100	145
A4	95-08	ADP, AHL, ANA, ARM, ALZ	1.6	07756005	231
A4	95-	ADR, AFY, APT, ARG, AVV	1.8	07757200	142
A4	95-	AEB, AJL, AMB, APU, ANB	1.8T	07757200	142
A4	95-	AVJ, AWT, BEX, BFB	1.8T	07757200	142
A4	08-	CABA/B, CDHA/B, CJEB	1.8 TFSI	07757300	142
A4	95-	1Z, AFF, AFN, AHH, AHU, AVG	1.9 TDI	07757900	145
A4	99-	AJM, ATJ, AVB, AVF, AWX, BKE, BRB	1.9 TDI PD	077562V2	144
A4	04-	BLB, BNA, BPW, BRC, BRD, BRE, BRF, BVA, BVF, BVG	2.0D TDI PD	077562V2	144
A4	07-	CAGA/B/C, CAHA/B, CJCA/B/C, CGLC/D, CMFA	2.0TDI CR	07757100	145
A4	00-	ALT	2.0	07757200	142
A4	02-05	AWA	2.0 FSI	07756700	142
A4	04-	BGB, BPG, BPJ, BUL, BWE, BWT, BYK	2.0 TFSI 16V	07756700	142
A4	08-	CDNB/C, CFKA	2.0 TFSI 16V	07757300	142
A4	97-	AGA, AJG, ALF, AMM, AML, APS, APZ, BDV	2.4I	07757400	143
A4	97-	AFB, AKE, AKN, AYM, BAU, BCZ, BDG, BDH, BFC	2.5 TDI	07757800	146
A4	05-	BPP, BSG, CAMA/B, CGKA/B	2.7 TDI V6	07757700	146
A4	96-01	ACK, ALG, APR, AQD	2.8I V6	07757400	143
A4	96-01	AMX, ATX	2.8 30V	07757400	143
A4	01-	ASN, BBJ	3.0	07756300	143
A4	05-	BKN, CCWB	3.0 TDI	07757700	146
A4	04-	AUK	3.2 FSI	07756800	143



MODEL	YEAR	ENGINE CODE	ENGINE SIZE	PART NO.	PAGE NO.
AUDI CONTINUED					
A4 ALLROAD	09-	CAHA/B, CAGA/B, CGLA/B/C/D	2.0 TDI PD CR	07757100	145
A4 ALLROAD	09-	CCWA	3.0 TDI PD CR	07757700	146
A4 CABR	01-	AMB, AVJ, BEX, BFB	1.8T	07757200	142
A4 CABR	03-09	ALT	2.0	07757200	142
A4 CABR	05-	BPW, BRC, BRE, BRF	2.0D TDI PD	077562V2	144
A4 CABR	05-	BPG, BWE, BWT	2.0 TFSI	07756700	142
A4 CABR	02-09	AMM, BDV	2.4	07757400	143
A4 CABR	03-	BCZ, BDG, BFC	2.5 TDI	07757800	146
A4 CABR	05-09	BPP	2.7 TDI	07757700	146
A4 CABR	02-09	ASN, BBJ	3.0	07756300	143
A4 CABR	05-09	ASB, BKN	3.0D TDI	07757700	146
A4 CABR	05-09	AUK	3.2 FSI	07756800	143
A4 QUATTRO	95-01	ADR, APT, ARG, AVV	1.8	07757200	142
A4 QUATTRO	95-01	AEB, AJL, APU, ANB, AWT	1.8T	07757200	142
A4 QUATTRO	95-01	AFN, AVG	1.9 TDI	07757900	145
A4 QUATTRO	99-01	AJM, ATJ	1.9 TDI PD	077562V2	144
A4 QUATTRO	97-	AGA, AJG, ALF, AML, AMM, APS, ARJ, APZ	2.4	07757400	143
A4 QUATTRO	97-	AFB, AKN	2.5D TDI	07757800	146
A4 QUATTRO	97-00	AGB	2.7T	07757400	143
A4 QUATTRO	96-	ACK, ALG, APR, AQD, AMX, ATX	2.8 30V	07757400	143
A4 QUATTRO	01-	AMB, AVJ, BEX, BFB	1.8T	07757200	142
A4 QUATTRO	01-04	AVF	1.9 TDI PD	077562V2	144
A4 QUATTRO	04-	BGB, BPG, BPJ, BUL	2.0 TFSI	07756700	142
A4 QUATTRO	04-	BWE, BWT, BYK	2.0 TFSI	07756700	142
A4 QUATTRO	04-	BLB, BRD, BRE, BPW	2.0 TDI PD	077562V2	144
A4 QUATTRO	01-	AKE, AYM, BAU, BDH	2.5D TDI	07757800	146
A4 QUATTRO	01-	ASN, BBJ	3.0	07756300	143
A4 QUATTRO	04-08	ASB, BKN	3.0 TDI	07757700	146
A4 QUATTRO	04-08	AUK	3.2 FSI	07756800	143
A4 QUATTRO	08-	CAHA, CAGA, CJCA, CGLC	2.0 TDI CR	07757100	145
A4 QUATTRO	07-	CAPA, CCWA/B, CCLA	3.0 TDI CR	07757700	146
A5	07-	CABD, CDHB, CJEB	1.8 TFSI	07757300	142
A5	09-	CDNB/C	2.0 TFSI 16V	07757300	142
A5	08-	CAGA/B, CAHA/B, CGLC/D, CJCA/B, CMEA	2.0 TDI CR	07757100	145
A5	07-	CAMA/B, CGKA/B	2.7 TDIPF	07757700	146
A5	08-	CCWA/B, CAPA	3.0 TDI	07757700	146
A6	95-	ADR, AJP	1.8	07757200	142
A6/QUATTRO	97-05	AEB, AJL, ANB, APU, AWT	1.8 20V T	07757200	142
A6/QUATTRO	94-	1Z, AFN, AHU, AVG	1.9 TDI	07757900	145
A6/QUATTRO	98-	AJM, AVF, AWX	1.9 TDI PD	077562V2	144
A6	94-97	AAE, ABK, ACE	2.0	07756005	231
A6	01-05	ALT	2.0	07757200	142
A6	06-	BPJ, BYK	2.0 TFSI 16V	07756700	142
A6	11-	CDNB	2.0 TFSI 16V	07757300	142
A6	05-	BLB, BNA, BRE, BRF, BVG	2.0 TDI PD	077562V2	144
A6	08-	CAHA, CAGB, CAHB, CGLC/D	2.0 TDI CR	07757100	145
A6/QUATTRO	97-05	AGA, AJG, ALF, ALW, AML, AMM, APC, APS, APZ, ARJ, ARM, ASM, BDV	2.4 V6	07757400	143
A6/QUATTRO	04-	BDW	2.4 V6	07756800	143
A6 ALLROAD/QUATTRO	97-05	AFB, AKE, AKN, AYM, BAU, BCZ, BDG, BDH, BFC	2.5 TDI	07757800	146

MODEL	YEAR	ENGINE CODE	ENGINE SIZE	PART NO.	PAGE NO.
AUDI CONTINUED					
A6 ALLROAD/QUATTRO	98-05	AJK, ARE, AZA, BES	2.7T	07757400	143
A6 ALLROAD/QUATTRO	05-	BPP, BSG, CANA/B/C/D	2.7 TDI V6	07757700	146
A6/QUATTRO	95-	ACK, AGE, ALG, AMX, APR, AQD, ATX	2.8	07757400	143
A6/QUATTRO	01-	ASN, BBJ	3.0	07756300	143
A6 ALLROAD/QUATTRO	05-	ASB, BMK, BMZ, BNG, CDYA/B/C	3.0 TDI	07757700	146
A6 ALLROAD/QUATTRO	04-	AUK, BKH	3.2 FSI	07756800	143
A6 QUATTRO	98-	ARS, ASG, AWN	4.2	07762700	144
A8	97-	AFB, AKE, AKN	2.5 TDI	07757800	146
A8	96-02	ACK, ALG, AMX, APR, AQD	2.8i V6	07757400	143
A8	03-	ASN, BBJ	3.0	07756300	143
A8	04-	ASB, BNG	3.0D TDI	07757700	146
A8	05-10	BPK	3.2 FSI	07756800	143
A8	98-	AKC, AQG, BFL	3.7	07762700	144
A8	03-	ASE	4.0D TDI	07757700	146
A8	98-	AQF, ARU, AUW, AVN, BFM	4.2 40V	07762700	144
A8	05-	BVN	4.2D TDI CR	07757700	146
Q3	11-	CCZC, CPSA	2.0 TFSI	07757300	142
Q3	11-	CFFA/B, CFGC/D	2.0 TDI CR	07757100	145
Q5	08-	CDNB/C	2.0 TFSI	07757300	142
Q5	08-	CAGA/B, CGLA/B, CAHA/B, CJCA/B	2.0 TDI CR	07757100	145
Q5	08-	CCWA/B	3.0 TDI	07757700	146
Q7	07-	BUG, BUN, CASA/B	3.0 TDI	07757700	146
Q7	07-	BTR	4.2 TDI	07757700	146
RS4	00-02	ASJ, AZR	2.7T	07757400	143
RS6	03-05	BCY, BRV	4.2	07762700	144
S3	99-	AMK, APY, BAM	1.8 TURBO	07757200	142
S3	06-	BHZ, BZC, CDLA/C	2.0 TFSI	07756700	142
S4	97-01	AGB, AZB	2.7 TURBO	07757400	143
S6/S8	99-04	ANK, AQH, AQJ, AVP, BBD	4.2	07762700	144
TT	98-	AJQ, AMU, APP, APX, ARY, AUM, AUQ, BAM, BVP, BVR, BFV	1.8/T	07757200	142
TT	11-	CDAA	1.8 TFSI	07757300	142
TT	08-	CDLA/B, CDMA	2.0 R	07756700	142
TT	08-	CBBB, CFGB	2.0 TDI CR	07757100	145
TT	08-	CCZA	2.0 TFSI	07757300	142
TT	07-	BPY, BWA	2.0 TFSI	07756700	142
TT	10-	CESA, CETA	2.0 TFSI	07757300	142
BMW					
116i (E87 81)	04-	N45 B16A/AC	1.6	07758700	149
116i (E87 81)	07-	N43 B16A/AA	1.6	07761400	150
116/118/120/123D (E87 81)	07-	N47 D20/A	2.0D	07758900	153
118/120D (E87 81)	04-	20 4D 4	2.0D	07759000	152
116/120 (E87 81)	07-	N43 B20, N43 B20AY	2.0	07761400	150
118i (E87 81)	05-	N46 B20, N46T B20BZ	2.0	07758200	150
120 (E87 81)	04-	N46 B20B, N46T B20, N46-B20O2	2.0	07758200	150
125, 130, 135	05-	N53, N52K, N54	3.0	07761500	151
316/318 (E36) / COMPACT	94-00	16 4E 2, 18 4E 2	1.6	07761100	148
318TDS (E36) / COMPACT	95-00	17 4T 1	1.7D	07767000	152
318S (E36) / COMPACT	92-98	18 4S 1	1.8	07758000	148

MODEL	YEAR	ENGINE CODE	ENGINE SIZE	PART NO.	PAGE NO.
BMW CONTINUED					
316 (E36) COMPACT	98-01	19 4E 1	1.9	07761100	148
318 (E36) COMPACT	96-01	19 4S 1	1.9	07761200	148
320 (E36)	92-99	20 6S 2/3	2.0	07761200	148
323/325 (E36) COMPACT	91-99	25 6S 1/2/3	2.5	07761200	148
325TD/S (E36)	91-99	25 6T 1/-L	2.5D	07767000	152
328 (E36)	95-99	28 6S 1	2.8	07761200	148
316 (E46)	99-01	16 4E 3	1.6	07761100	148
316 (E46) / COMPACT	02-07	N40/N45 B16A	1.6	07758700	149
316 (E46) / COMPACT	01-07	N42 B18A,N46 B18	1.8	07758200	150
316 (E46)	99-04	19 4E 1	1.9	07761100	148
318TD (E46) / COMPACT	03-04	20 4D 1/4	2.0D	07759000	152
320 (E46) / COMPACT	01-06	N42 B20A, N46 B20	2.0	07758200	150
320D (E46)	98-05	20 4D 1/4	2.0D	07759000	152
320 (E46)	98-	20 6S 4, 22 6S 1	2.0/2.2	07758000	148
323/325 (E46) / COMPACT	98-05	25 6S 4/5	2.5	07758000	148
328i (E46)	98-01	28 6S 2	2.8	07758000	148
330D (E46)	99-	30 6D 1/2	3.0D	07759000	152
330 (E46)	00-	30 6S 3	3.0	07758000	148
316i (E90/91/92/93)	05-	N45 B16A, N45T B16	1.6	07758700	149
316i (E90/91/92/93)	07-	N43 B16	1.6	07761400	150
316/318/320D (E90/91/92/93)	07-	N47 D20A	2.0D	07758900	153
318/320D (E90/91/92/93)	05-	20 4D 4	2.0D	07759000	152
318/320i (E90/91/92/93)	05-	N46 B18/B20, N46T B20	2.0	07758200	150
318/320i (E90/91/92/93)	07-	N43 B20	2.0	07761400	150
323i (E90/91/92/93) /Xi	05-	N52 B25	2.5	07761500	151
325/330D (E90/91/92/93)	05-	30 6D 3	3.0D	07759000	152
325/330/335i (E90/91/92/93) /Xi	06-	N52 B30, N53 B30/A, N54 B30A	3.0	07761500	151
335D (E90/91/92/93) /Xi	06-	30 6D 5	3.0D	07759000	152
520D (E39)	00-03	20 4D 1	2.0D	07759000	152
520 (E39)	96-00	20 6S 3	2.0	07761200	148
520 (E39)	98-03	20 6S 4, 22 6S 1	2.0/2.2	07758000	148
523i (E39)	96-00	25 6S 3	2.5	07761200	148
523i (E39)	98-03	25 6S 4	2.5	07758000	148
523i (E39)	98-03	25 6S 4	2.5	07758000	148
525D (E39)	00-03	25 6D 1	2.5D	07759000	152
525 (E39)	00-03	25 6S 5	2.5	07758000	148
525TD/TDS (E39)	97-03	25 6T 1	2.5D	07767000	152
528 (E39)	96-00	28 6S 1	2.8	07761200	148
528 (E39)	98-00	28 6S 2	2.8	07758000	148
530D (E39)	98-03	30 6D 1	3.0D	07759000	152
530 (E39)	00-03	30 6S 3	3.0	07758000	148
520D (E60/61)	05-	204D4	2.0D	07759000	152
520D (E60/61)	05-	N47D20A	2.0D	07758900	153
520i (E60/61)	07-	N43 B20	2.0	07761400	150
520i (E60/61)	07-	N46T B20	2.0	07758200	150
520i (E60/61)	03-	22 6S 1	2.2	07758000	148

MODEL	YEAR	ENGINE CODE	ENGINE SIZE	PART NO.	PAGE NO.
BMW CONTINUED					
523i (E60/61)	05-	N52/N53 B25	2.5	07761500	151
525i (E60/61)	03-	25 6S 5	2.5	07758000	148
525i (E60/61)	05-	N52 B25, N53 B30	2.5/3.0	07761500	151
525/530D (E60/61)	03-	30 6D 2/3	3.0D	07759000	152
530 (E60/61)	03-	30 6S 3	3.0	07758000	148
530 (E60/61)	07-	N52-B30	3.0	07761500	151
535D (E60/61)	04-	30 6D 4	3.0D	07759000	152
540/545/548 (E60/61)	03-	N62 B40/B44/B48	4.0/4.4/4.8	07759200	151
520D (F10/11)	10-	N47 D20	2.0D	07758900	153
523 (F10/11)	10-	N52 B25.N53 B30	2.5/3.0	07761500	151
528 (F10/11)	10-	N52/53 B30	3.0	07761500	151
630 (E63/64)	04-	N52/53-B30	3.0	07761500	151
635D (E63/64)	07-	30 6D 5	3.0D	07759000	152
645i (E63/64)	03-06	N62 B44/B48	4.4/4.8	07759200	151
725TDS (E38)	96-02	25 6T 1	2.5D	07767000	152
728i (E38)	94-01	28 6S 1	2.8	07761200	148
728i (E38)	98-02	28 6S 2	2.8	07758000	148
730D (E38)	98-02	30 6D 1	3.0D	07759000	152
750i (E38)	94-02	54 12 1/2	5.4	07758000	148
730 (E65/66)	02-05	30 6S 3	3.0	07758000	148
730 (E65/66)	05-	N52 B30	3.0	07761500	151
730D (E65/66)	02-	30 6D 2/3	3.0D	07759000	152
735/740/745/750 (E65/66)	02-	N62 B36A/B40/B44/B48A	3.6/4.0/4.4/5.0	07759200	151
760 (E65/66)	02-	N73 B60A	6.0	07759200	151
730/740 (F01/02/04)	08-	N52 D30, N54 B30	3.0	07761500	151
850/CSI (E31)	90-99	50 12 A, 54 12 1, 56 12 1	5.0	07758000	148
X1 (E84)	10-	N46T B20	2.0	07758200	150
X1 (E84)	09-	N47 D20	2.0D	07758900	153
X1 (E84)	10-	N52/K B30	3.0	07761500	151
X3 (E83)	05-	N46 B20	2.0	07758200	150
X3 (E83)	04-	20 4 D4	2.0D	07759000	152
X3 (E83)	07-	N47 D20	2.0D	07758900	153
X3 (E83)	04-07	25 6S 5	2.5	07758000	148
X3 (E83)	06-	N52 B25	2.5SI	07761500	151
X3 (E83)	03-	30 6S 3	3.0	07758000	148
X3 (E83)	06-	N52 B30	3.0SI	07761500	151
X3 (E83)	03-	30 6D 2/3/5 (E83)	3.0D	07759000	152
X3 (F25)	11-	N47 D20	2.0D	07758900	153
X3 (F25)	11-	N52 B30	3.0	07761500	151
X5 (E53)	99-	30 6S 3	3.0	07758000	148
X5 (E53)	00-	30 6D 1 /2	3.0DT	07759000	152
X5 (E53)	03-	N62 B44A, N62 B48A	4.4/4.6	07759200	151
X5 (E70)	06-	N52 B30	3.0	07761500	151
X5 (E70)	07-	30 6D 3/ 5	3.0D/DT	07759000	152
X5 (E70)	06-	N62 B48A/B	4.8	07759200	151
X6 (E71/E72)	08-	N54 B30A	3.0	07761500	151
X6 (E71/E72)	08-	30 6D 3/5	3.0D	07759000	152
Z3 (E36)	96-99	18 4 E2	1.8	07761100	148
Z3 (E36)	96-99	19 4S 1	1.9	07761200	148
Z3 (E36)	98-03	19 4E 1	1.9	07761100	148
Z3 (E36)	99-01	20 6S 4/22 6S 1	2.0/2.2	07758000	148
Z3 (E36)	97-99	28 6 S1	2.8	07761200	148
Z3 (E36)	99-03	28 6 S2, 30 6S 3	2.8/3.0	07758000	148
Z4 (E85)	05-07	N46 B20	2.0	07758200	150
Z4 (E85)	03-	22 6S 1, 25 6S 5	2.2/2.5	07758000	148
Z4 (E89)	06-	N52K B25/A, N52 B30	2.5/3.0	07761500	151
Z4 (E89)	09-	N52B30A, N54B30A	3.0	07761500	151
Z4 (E85)	03-05	30 6S 3	3.0	07758000	148

MODEL	YEAR	ENGINE CODE	ENGINE SIZE	PART NO.	PAGE NO.
CHEVROLET					
AVEO	11-	LWD/A12XEL, LDC/A12XER	1.2	07763500	154
AVEO	11-	LDD/A14XER/A14XEL	1.4	07763500	154
AVEO	08-	G14D	1.4 16V	07753900	154
AVEO	08-	LXV/LDE/F16D4	1.6	07753900	154
CAPTIVA	07-11	Z20S1	2.0D VCDI	07753800	154
CRUZE	09-	LXV/LDE/F16D4	1.6	07753900	154
CRUZE	11-	ZHO	1.8	07753900	154
CRUZE	09-	LLW/Z20DMH	2.0CR	07753800	154
EPICA	06-	RA420/Z20S1	2.0D VCDI	07753800	154
LACETTI	07-	Z20DM	2.0D VCDI	07753800	154
NUBIRA	07-	Z20DM	2.0D VCDI	07753800	154
ORLANDO	11-	ZHO/Z18XER	1.8	07753900	154
CHRYSLER					
GRAND VOYAGER	01-08	EDZ	2.4	07761600	155
GRAND VOYAGER	01-	R2516C, R2816C5	2.5/2.8CRD	07762000	155
NEON	95-04	ECB, ECC	2.0	07761600	155
PT CRUISER	00-05	ECC	2.0	07761600	155
PT CRUISER	02-	EDJ	2.2CRD	07760000	155
PT CRUISER	01-	EDZ	2.4	07761600	155
STRATUS / CABR	94-01	ECB	2.0	07761600	155
VOYAGER	97-01	ECB	2.0	07761600	155
VOYAGER	01-08	EDZ	2.4	07761600	155
VOYAGER	01-	R2516C, R2816C5	2.5/2.8CRD	07762000	155
CITROËN					
BERLINGO	99-04	HDY, HDZ, HFX	1.1	07754300	158
BERLINGO	01-04	KFW	1.4	07754500	156
BERLINGO	97-99	KFX	1.4	07754300	158
BERLINGO	00-02	NFU	1.6	07754300	158
BERLINGO	06-	9HW, 9HX, 9HY	1.6HDI	07763900	159
BERLINGO	97-02	LFX	1.8	07754300	158
BERLINGO	96-99	A9A	1.8D	07754400	160
BERLINGO	96-	DJY, D9B, WJY, WJZ	1.9D	07754400	160
BERLINGO	99-02	RHY, RHZ	2.0 HDI	07764000	161
BERLINGO III	08-	NFR, NFU	1.6	07754300	158
BERLINGO III	09-	5FK, 5FS	1.6 VTI	07759400	156
BERLINGO III	08-	9HT, 9HV, 9HW, 9HX, 9HZ	1.6 HDI	07763900	159
C1	05-	8HT (DV4TD)	1.4D HDI	07763900	159
C2	03-	HFX	1.1	07754300	158
C2	03-	KFV, KFU	1.4	07754500	156
C2	02-	8HX,8HZ	1.4 HDI	07763900	159
C2	03-	NFS, NFU	1.6/VTS	07754300	158
C2	07-	9HZ	1.6 HDI	07763900	159
C3	02-	HFX	1.1	07754300	158
C3	02-	KFU, KFV	1.4	07754500	156
C3	02-	8HR, 8HV, 8HW, 8HX, 8HY, 8HZ	1.4 HDI 8V	07763900	159
C3	02-	NFU	1.6	07754300	158
C3	05-	9HX, 9HY, 9HZ	1.6D HDI	07763900	159
C3	09-	8FP, 8FR, 8FS	1.4 VTI	07759400	156
C3	10-	5FP, 5FS	1.6 VTI	07759400	156
C3 PICASSO	09-	8FP, 8FS	1.4 VTI	07759400	156
C3 PICASSO	09-	5FP, 5FS, 5FW	1.6 VTI	07759400	156
C3 PICASSO	09-	9HX, 9HZ	1.6D HDI	07763900	159
C4	04-	KFU	1.4	07754500	156
C4	04-	NFU	1.6	07754300	158
C4	08-	5FT, 5FX	1.6 THP	07759500	157

MODEL	YEAR	ENGINE CODE	ENGINE SIZE	PART NO.	PAGE NO.
CITROËN CONTINUED					
C4	08-	5FW	1.6 VTI	07759400	156
C4	04-	9HV, 9HX, 9HY, 9HZ	1.6D HDI	07763900	159
C4	04-	RFJ, RFK, RFN	2.0	07754100	159
C4	04-	RHE, RHF, RFR	2.0D HDI	07764000	161
C4 II	11-	8FP, 8FR	1.4 VTI	07759400	156
C4 II	11-	5FV	1.6 THP	07759500	157
C4 II	11-	5FS	1.6 VTI	07759400	156
C4 GRAND PICASSO	08-	5FT, 5FV, 5FX	1.6 THP	07759500	157
C4 GRAND PICASSO	08-	5FS, 5FW	1.6 VTI	07759400	156
C4 GRAND PICASSO	06-	9HY, 9HZ	1.6D HDI	07763900	159
C4 GRAND PICASSO	06-	6FY	1.8	07754100	159
C4 GRAND PICASSO	06-	RFJ	2.0	07754100	159
C4 GRAND PICASSO	06-	RHE, RHH, RHJ, RHR	2.0D HDI	07764000	161
C5	00-	6FZ	1.8 16V	07754100	159
C5	00-04	RFN, RLZ	2.0 16V/HPI	07754100	159
C5	00-04	RHS, RHY, RHZ	2.0 HDI	07764000	161
C5	00-	4HX	2.2 HDI	07764000	161
C5 II	04-	9HY, 9HZ	1.6D HDI	07763900	159
C5 II	04-	6FY, 6FZ	1.8	07754100	159
C5 II	04-	RFJ	2.0 16V	07754100	159
C5 II	04-	RHR	2.0 HDI	07764000	161
C5 II	07-	4HP, 4HR, 4HS, 4HT, 4HX	2.2 HDI	07764000	161
C5 III	09-	5FN, 5FV	1.6 THP	07759500	157
C5 III	10-	5FS	1.6VTI	07759400	156
C5 III	07-	9HZ	1.6D HDI	07763900	159
C5 III	07-	6FY	1.8	07754100	159
C5 III	07-	RFJ	2.0	07754100	159
C5 III	08-	RHE, RHF, RHH, RHR	2.0 HDI	07764000	161
C5 III	07-	4HL, 4HP, 4HT	2.2 HDI	07764000	161
C5 III	07-	UHZ	2.7 HDI	07754200	160
C6	06-	4HP, 4HS, 4HT	2.2 HDI	07764000	161
C6	05-	UHZ	2.7 HDI	07754200	160
C8	02-	RFJ, RFN	2.0 16V	07754100	159
C8	02-	RHD, RHH, RHK, RHM, RHR, RHT, RHW	2.0 HDI	07764000	161
C8	02-	3FZ	2.2	07754100	159
C8	02-	4HP, 4HR, 4HS, 4HT, 4HW	2.2 HDI	07764000	161
C-CROSSER	07-	4HN, 4HK	2.2 HDI	07764000	161
DISPATCH / JUMPY	94-99	D9B XUD9A/AU	1.9D	07754400	160
DISPATCH / JUMPY	99-	DW8/L/W3 WJY XUD9Y, WJZ	1.9D	07754400	160
DISPATCH / JUMPY	95-	D8B XUD9TF/DHX	1.9 DT	07754400	160
DISPATCH / JUMPY	00-	RFN	2.0	07754100	159
DISPATCH/ JUMPY	99-	RHM, RHW, RHX, RHZ	2.0 HDI	07764000	161
DISPATCH/ JUMPY	94-99	P8C	2.1.DT	07754400	160
DISPATCH / JUMPY III	07-	9HU	1.6 HDI	07763900	159
DISPATCH / JUMPY III	07-	RFH, RHJ	2.0	07754100	159
DISPATCH / JUMPY III	07-	AHY, AHZ, RHG, RHH, RHK, RHR	2.0 HDI	07764000	161

MODEL	YEAR	ENGINE CODE	ENGINE SIZE	PART NO.	PAGE NO.
CITROËN CONTINUED					
DS3	09-	8FP, 8FR	1.4VTI	07759400	156
DS3	09-	5FD, 5FN, 5FR, 5FV, 5FX	1.6 THP/ RACING	07759500	157
DS3	10-	5FS	1.6 VTI	07759400	156
DS4	11-	5FV	1.6 THP	07759500	157
DS4	11-	5FS	1.6 VTI	07759400	156
DS4	11-	RHH	2.0D HDI	07764000	161
DS5	12-	5FE, 5FM, 5FU, 5FV	1.6 THP	07759500	157
DS5	12-	RHC, RHD, RHH	2.0D HDI	07764000	161
JUMPER / RELAY	95-	D9B, DJY, DHX, D8C	1.9D/TD	07754400	160
JUMPER / RELAY	94-	RFW	2.0L	07754300	158
JUMPER / RELAY	01-	RHV	2.0 HDI	07764000	161
JUMPER / RELAY	94-02	T9A, T8A, THZ, THX	2.5D/TD/TDI	07754400	160
JUMPER / RELAY	01-	8140.43/43S/63	2.8D/HDI/TDI	07751500	161
JUMPER / RELAY II	02-	RHV, 4HY	2.0/2.2D HDI	07764000	161
JUMPER / RELAY III	06-	4HG, 4HH, 4HJ, 4HM, 4HU, 4HV	2.2 HDI	07764500	162
JUMPER / RELAY III	06-	F1CE0381/D/E/N	3.0 HDI	07764500	162
NEMO	07-	8HS	1.4 HDI	07763900	159
SAXO	96-03	CDY, CDZ, HDY, HDX, HFX	1.0/1.1	07754300	158
SAXO	00-03	KFW, KFX	1.4	07754300	158
SAXO	96-03	VJY, VJZ	1.5D	07754400	160
SAXO	96-03	NFT, NFZ, NFZ	1.6	07754300	158
SYNERGIE / EVASION	97-00	LFW	1.8	07754300	158
SYNERGIE / EVASION	94-00	D8B, DHX	1.9D/TD	07754400	160
SYNERGIE / EVASION	94-00	RFU, RFV	2.0	07754300	158
SYNERGIE / EVASION	99-02	RHW, RHZ	2.0 HDI	07764000	161
SYNERGIE / EVASION	94-00	RGX	2.0T	07754300	158
SYNERGIE / EVASION	96-00	P8C	2.1TD	07754400	160
XANTIA	93-01	BFZ	1.6	07754300	158
XANTIA	95-01	LFX, LFY, LFZ	1.8	07754300	158
XANTIA	93-01	D9B, DJZ, DHW, DHX, DHY	1.9D/DT	07754400	160
XANTIA	93-01	RFX, RFV, RFY	2.0	07754300	158
XANTIA	98-01	RHY, RHZ	2.0 HDI	07764000	161
XANTIA	95-01	RGX	2.0 LT	07754300	158
XANTIA	96-98	P8C	2.1 DT	07754400	160
XM	89-00	R6A, RFV, RFZ, RGX, RGY	2.0	07754300	158
XM	89-00	P8A, P8B, P8C, P9A, PHZ,	2.1 DT	07754400	160
XM	94-01	THY	2.5 DT	07754400	160
XSARA	97-00	KFX	1.4	07754300	158
XSARA	97-00	VJY, VJZ	1.5D	07754400	160
XSARA	97-00	NFZ	1.6	07754300	158
XSARA	97-00	LFX, LFY, LFZ	1.8	07754300	158
XSARA	98-04	DJY, WJZ (DW8) DHV, DHX, DHY	1.9D/DT	07754400	160
XSARA	97-00	RFS, RFV	2.0 16V	07754300	158
XSARA	99-	RHY	2.0 HDI	07764000	161

MODEL	YEAR	ENGINE CODE	ENGINE SIZE	PART NO.	PAGE NO.
CITROËN CONTINUED					
XSARA II	00-04	KFW	1.4	07754500	156
XSARA II	02-04	8HZ	1.4 HDI 8V	07763900	159
XSARA II	00-06	NFU	1.6 16V	07754300	158
XSARA II	00-04	WJY/WJZ (DW8)	1.9D	07754400	160
XSARA II	00-02	RFN	2.0 16V	07754100	159
XSARA II	00-04	RFS	2.0 16V	07754300	158
XSARA II	99-	RHY, RHZ	2.0 HDI	07764000	161
XSARA PICASSO	99-00	NFV, NFU, NFZ	1.6	07754300	158
XSARA PICASSO	04-	9HX, 9HY, 9HZ	1.6HDI	07763900	159
XSARA PICASSO	99-07	6FZ	1.8	07754100	159
XSARA PICASSO	02-	RFN	2.0 16V	07754100	159
XSARA PICASSO	00-	RHY	2.0 HDI	07764000	161
DACIA					
DUSTER	10-	K9K796/884/896/898/ 892/894	1.5 DCI	07755700	163
DUSTER	10-	K4M606/616/690/696	1.6	07755100	163
LOGAN	05-	K4M690/697	1.6	07755100	163
SANDERO	08-	K9K792/796/892	1.5 DCI	07755700	163
SANDERO	08-	K4M690/696/697	1.6	07755100	163
FIAT					
500/C	10-	312A2.000	0.9	07763100	164
500/C	07-	169A4.000	1.2 8V	07751900	164
500	07-	169A1.000, 199B1.000	1.3MJTD 16V	07761900	168
500/C (ABARTH)	07-	169A3.000, 312A1.000	1.4	07763300	165
500L	12-	312A2.000	0.9	07763100	164
BARCETTA	95-00	183A1000	1.8 16V	07751C00	166
BARCETTA	00-04	188A6.000	1.8 16V	07761800	166
BRAVA	98-	182B2.000, 188A5.000	1.2 16V	07763300	165
BRAVA	97-01	182A3/A5.000	1.4	07751A00	165
BRAVA	95-	182A4/A6/B6.000	1.6 16V	07751B00	166
BRAVA	95-00	182A2.000	1.8 16V	07751C00	166
BRAVA	95-02	182A7/A8/B4/B9.000	1.9TD (75)	07751700	168
BRAVO	98-02	182B2.000, 188A5.000	1.2 16V	07763300	165
BRAVO	95-98	182A3/A5.000	1.4 12V	07751A00	165
BRAVO	95-02	182A4/A6.000, 182B6.000	1.6 16V	07751B00	166
BRAVO	95-02	182A2.000	1.8 16V	07751C00	166
BRAVO	95-02	182A7/A8/B4/B9.000	1.9 TD/JTD (75 CV)	07751700	168
BRAVO	95-01	182A1/B7.000	2.0	SP23110-F	167
BRAVO	95-01	182A1/B7.000 (TURBO)	2.0	SP23110-J	167
BRAVO	07-	192B2.000, 198A1/198A4.000	1.4	07763300	165
BRAVO	07-	198A7.000	1.4	07763200	165
BRAVO	07-	198A2A3/A6.000	1.6JTD	07751700	168
BRAVO	07-	192A8/B4/B5.000, 937A5.000	1.9JTD	07751700	168
BRAVO	08-	198A5.000	2.0JTD	07751700	168
CROMA	06-	939A4.000	1.8	07753900	167
CROMA	05-11	939A1/A2.000	1.9D JTDM	07751700	168
CROMA	07-11	939A7/A8.000	1.9DM	07751700	168
CROMA	05-09	194A1.000	2.2	07753700	167
CROMA	05-11	939A3.000	2.4JTDM	07751700	168
DOBLO	04-	188A9.000, 199A2/A3.000	1.3JTD/M	07761900	168
DOBLO	04-	223A9.000, 263A2.000	1.3JTD/M	07761900	168
DOBLO	05-10	350A1.000	1.4	07751900	164
DOBLO	01-06	182B6.000	1.6 16V	07751B00	166
DOBLO	01-06	182B9.00, 223A6.000	1.9D/JTD	07751700	168
DOBLO	04-10	186A9.000, 223A7/B1.000	1.9 JTDM	07751700	168

MODEL	YEAR	ENGINE CODE	ENGINE SIZE	PART NO.	PAGE NO.
FIAT					
DOBLO	10-	198A4.000, 843A1.000	1.4	07763300	165
DOBLO	10-	198A3.000, 263A3/A4/A5.000	1.6D	07751700	168
DOBLO	10-	263A1.000	2.0JTDM	07751700	168
DUCATO	98-02	DHX, DJY	1.9D/DT	07754400	160
DUCATO	02-	RHV	2.0 JTD	07764000	161
DUCATO	11-	250A1.000	2.0D	07751700	168
DUCATO	06-	4HV	2.2DJTDM	07764500	169
DUCATO	02-	F1AE0481C	2.3D JTD	07751600	169
DUCATO	06-	F1AE3481N, F1AE0481D/N	2.3DJTDM	07764500	169
DUCATO	06-	F1CE0381D/E, F1CE481D	3.0JTD	07764500	169
DUCATO	94-02	8140.47/47R/67	2.5D/DT	07751500	169
DUCATO	98-	8140.43/43N/43S/63	2.8D	07751500	169
FIORINO	08-	199A2.000	1.3JTD	07761900	168
FIORINO	09-	350A1.000	1.4	07751900	164
GRAND PUNTO	05-	169A4.000, 199A4.000	1.2	07751900	164
GRAND PUNTO	05-	199A2/A3.000, 223A9.000	1.3JTD	07761900	168
GRAND PUNTO	05-	350A1.000	1.4 8V	07751900	164
GRAND PUNTO	07-	198A4.000, 199A6/A8.000	1.4	07763300	165
GRAND PUNTO	08-	955A3.000	1.6D	07751700	168
GRAND PUNTO	05-	199A5.000, 939A1.000	1.9JTD	07751700	168
IDEA	04-	188A5.000	1.2	07763300	165
IDEA	04-	188A9.000, 199A3/B1.000	1.3JTD	07761900	168
IDEA	05-	350A1.000	1.4	07751900	164
IDEA	04-	192B2.000, 843A1.000	1.4	07763300	165
IDEA	08-	350A2.000	1.6D	07751700	168
IDEA	04-	188B2.000	1.9JTD	07751700	168
LINEA	07-	199A3.000	1.3JTD	07761900	168
LINEA	07-	350A1.000	1.4	07751900	164
LINEA	07-	198A4.000	1.4	07763300	165
LINEA	08-	198A3.000	1.6D	07751700	168
MAREA	98-00	182B2.000	1.2	07763300	165
MAREA	96-00	182A3.000	1.4 12V	07751A00	165
MAREA	96-03	182A4/B6.000	1.6 16V	07751B00	166
MAREA	96-03	182A2.000	1.8 115 16V	07751C00	166
MAREA	96-99	182A7/A8.000	1.9D/TD	07751700	168
MAREA	99-03	182B4/B9.000, 186A6.000	1.9 JTD	07751700	168
MAREA	96-99	182A1/B7.000	2.0	SP23110-F	167
MAREA	96-99	182A1/B7.000 (TURBO)	2.0	SP23110-J	167
MAREA	96-03	185A2/A6.000	2.4DT/JTD	07751700	168
MULTIPLA	99-	182A4/B6.000	1.6 16V	07751B00	166
MULTIPLA	99-	186A6/A8/A9.000, 182B4.000	1.9 JTD	07751700	168
PALIO WEEKEND	00-	188A4.000	1.2	07764300	164
PALIO WEEKEND	01-	188A5.000	1.2 16V	07763300	165
PALIO WEEKEND	00-	182B6.000	1.6 16V	07751B00	166
PALIO WEEKEND	00-	188A2.000, 223A6.000	1.9 D JTD	07751700	168
PANDA	12-	312A2.000	0.9	07763100	164
PANDA	03-	188A4.000	1.2	07764300	164
PANDA	09-	169A4.000	1.2 8V	07751900	164
PANDA	03-	169A1/A5.000, 188A8.000	1.3 JTD	07761900	168
PANDA	06-	169A3.000	1.4 16V	07763300	165
PANDA	10-	350A1.000	1.4 16V	07751900	164

MODEL	YEAR	ENGINE CODE	ENGINE SIZE	PART NO.	PAGE NO.
FIAT CONTINUED					
PUNTO	12-	312A2.000	0.9	07763100	164
PUNTO	97-	176B9.000, 188A5.000	1.2	07763300	165
PUNTO	99-	188A4.000	1.2	07764300	164
PUNTO	03-	188A9.000	1.3 JTD	07761900	168
PUNTO	03-	843A1.000	1.4	07763300	165
PUNTO	12-	350A1.000	1.4	07751900	164
PUNTO	99-03	183A1.000	1.8	07751C00	166
PUNTO	01-	183A6.000, 188A6.000	1.8	07761800	166
PUNTO	99-	188A2/A3/A7.000, 188B2.000	1.9D JTD	07751700	168
PUNTO EVO	09-	169A4.000, 199A4.000	1.2	07751900	164
PUNTO EVO	09-	199A2/A3/A9.000, 199B1/B2.000, 223A9.000	1.3 JTD	07761900	168
PUNTO EVO	09-	199A7.000, 350A1.000	1.4 8V	07751900	164
PUNTO EVO	09-	955A2/A6.000	1.4	07763200	165
PUNTO EVO	09-	955A3.000	1.6D	07751700	168
QUBO	08-	199A2.000	1.3JTD	07761900	168
QUBO	09-	350A1.000	1.4	07751900	164
SCUDO	07-	9HU	1.6JTDM	07763900	159
SCUDO	96-04	D8B, D9B, DHX, WJY, WJZ	1.9D/TD	07754400	160
SCUDO	99-	RHK, RHM, RHR, RHW, RHX, RHZ	2.0 JTD	07764000	161
SEDICI	06-	D19AA, D20AA	1.9DM, 2.0DM	07751700	168
STILO	01-	188A5.000	1.2 16V	07763300	165
STILO	04-	192B2.000, 843A1.000	1.4 16V	07763300	165
STILO	01-	182B6.000	1.6 16V	07751B00	166
STILO	05	192B3.000 (Z16XEP)	1.6 16V	07753900	167
STILO	01-	192A4.000	1.8	07761800	166
STILO	01-	192A1/A3/A9.000	1.9 JTD	07751700	168
STILO	04-	192A5/A8.000, 937A5.000	1.9 JTDM	07751700	168
STRADA	00-06	188A4.000	1.2	07764300	164
STRADA	06-	223A9.000	1.3JTDM	07761900	168
STRADA	00-	188A2.000, 223A6.000	1.9D/JTD	07751700	168
ULYSSE	96-	LFW	1.8	07754300	158
ULYSSE	95-	D8B, DHX	1.9D/TD	07754400	160
ULYSSE	94-	RFU, RFV, RGX	2.0	07754300	158
ULYSSE	99-	RHK,RHM, RHR, RHT, RHW, RHZ	2.0JTD	07764000	161
ULYSSE	96-99	P8C	2.1TD	07754400	160
ULYSSE	02-	4HP, 4HR, 4HS, 4HT, 4HW	2.2JTD	07764000	161
FORD					
COUGAR	98-01	EDBA/B/C/D	2.0 ZETEC E SEFI	077523V2	170
FIESTA 1V	95-02	DHA/B/C/D/E/F/G	1.25	077523V2	170
FIESTA 1V	95-00	FHA, FHE	1.4	077523V2	170
FIESTA 1V	00-02	L1T, L1V	1.6	077523V2	170
FIESTA 1V	96-02	RTJ/RTK	1.8D	07752700	172
FIESTA 1V	00-02	C9DC, RTN/RTQ/RTP	1.8 DT	07752500	173
FIESTA V	02-	F8JA/B, FUJA/B, M7JA/B	1.25 16V	077523V2	170
FIESTA V	02-	FXJA/B	1.4 16V	077523V2	170
FIESTA V	02-08	F6JA/B/C	1.4 TDCI	07763900	175
FIESTA V	02-08	FYJA/B	1.6	077523V2	170
FIESTA V	05-08	HHJA/B	1.6TDCI	07763900	175
FIESTA V	05-08	N4JB	2.0 16V	077523V2	170
FIESTA VI	08-	SNJA/B, STJA/B	1.25 16V	077523V2	170
FIESTA VI	08-	SPJA/C, RTJA/B	1.4	077523V2	170
FIESTA VI	08-	F6JD, HHJC/D/E/F, TZJA/B, UBJA	1.4/1.6TDCI	07763900	175
FIESTA VI	08-	HXJA, HXJB, RVJA	1.6 TI VCT	07752600	171

MODEL	YEAR	ENGINE CODE	ENGINE SIZE	PART NO.	PAGE NO.
FORD CONTINUED					
FOCUS	98-05	FXDA/B/C/D, FYDA/B/C/D/H	1.4 ZETEC-SE SFI	077523V2	170
FOCUS	04-	FXJA, ASDA, ASDB	1.4 16V DURATEC	077523V2	170
FOCUS	04-	HWDA/B, SHDA/B/C	1.6 16V DURATEC	077523V2	170
FOCUS	04-	HXDA/B, SIDA	1.6 16V TI	07752600	171
FOCUS	11-	IQDB, MUDA, PNDA, XTDA	1.6 16V TI VCT	07752600	171
FOCUS	04-	G8DA/B/D/E/F, HHDA/B, GPDA/C, MTDA	1.6 16V TDCI	07763900	175
FOCUS	11-	TZJA, T1DA/B, T3DA/B, UBJA	1.6 16V TDCI	07763900	175
FOCUS	98-05	EYDB/C/D/E/F/G/H/J/L	1.8 ZETEC-E SFI	077523V2	170
FOCUS	04-	QQDA/B/C, Q7DA	1.8 16V DURATEC	077523V2	170
FOCUS	01-	F9DA, F9DB, FFDA, KKDA/B	1.8 DURATORQ TDCI	07752500	173
FOCUS	98-	C9DA/B/C, BHDA/B	1.8D ENDURA -TDDI	07752500	173
FOCUS	98-	EDDB/C/D/F	2.0 ZETEC-E SFI	077523V2	170
FOCUS	04-	AODA/B/E, SYDA	2.0 16V	077523V2	170
FOCUS	01-05	ALDA, HMDA	2.0RS/ST 170	077523V2	170
FOCUS	04-	G6DA/B/C/D/E/F/G, IXDA	2.0 16V TDCI	07752700	172
FOCUS	11-	UFDB, TXDB, TYDA	2.0 16V TDCI	07752700	172
FOCUS	04-05	QJBA	2.2 TDCI	07752700	172
FOCUS C MAX	03-	HWDA, HWDB, SHDA/B	1.6	077523V2	170
FOCUS C MAX	03-	HXDA, IQDA/B, PNDA, SIDA	1.6 TIVCT	07752600	171
FOCUS C MAX	03-	GPDA/C, G8DA/B/D/E/F, HDA/B	1.6TDCI	07763900	175
FOCUS C MAX	10-	TZJA, T1DA, T3DA, UBJA	1.6TDCI	07763900	175
FOCUS C MAX	03-	CSDA/B, QQDA/B/C, Q7DA	1.8	077523V2	170
FOCUS C MAX	03-	BHPA, HCPA, KKDA	1.8D TDCI	07752500	173
FOCUS C MAX	03-	AODA, AODB, AODE, SYDA	2.0	077523V2	170
FOCUS C MAX	03-	G6DA/B/C/D/E/F/G, IXDA	2.0 TDCI	07752700	172
FOCUS C MAX	10-	TXDA/B, TYDA, UFDB, UKDB	2.0 TDCI	07752700	172
FOCUS C MAX GRAND	10-	IQDA/B, PNDA	1.6 TIVCT	07752600	171
FOCUS C MAX GRAND	10-	TZJA, T1DA, T3DA, UBJA	1.6TDCI	07763900	175
FOCUS C MAX GRAND	10-	TXDA/B, TYDA, UFDB, UKDB	2.0 TDCI	07752700	172
FUSION	02-	F8JA/B, FUJA/B	1.25	077523V2	170
FUSION	02-	FXJA/B/C, UTJA	1.4	077523V2	170
FUSION	02-	F6JA/B/C	1.4 TDCI	07763900	175
FUSION	02-	FYJA/B/C	1.6	077523V2	170
FUSION	04-	HHJA/B	1.6 TDCI	07763900	175
KA	09-	AAAA	1.2	07751900	164
KA	09-	BAAA, BAAB	1.3 TDCI	07751800	172
GALAXY	11-	T1BA/B	1.6 TDCI	07763900	175
GALAXY	06-	FFWA, QYWA	1.8 TDCI	07752500	173
GALAXY	95-99	1Z, AFN, AHU, AVG	1.9 TDI	07757900	220
GALAXY	99-06	ANU, ASZ, ASZ1, AUY, BTB	1.9 TDI PD	077562V2	221
GALAXY	06-	AOWA/B, TBWA/B	2.0 FFV/PFI	077523V2	170
GALAXY	06-	AZWA/C, KLWA, QXWA/B, TYWA, TXWA, UFWA, UKWA	2.0 TDCI	07752700	172
GALAXY	08-	Q4BA, Q4WA, SEWA	2.2 TDCI	07752800	174
GALAXY	07-	SEWA	2.3 16V	077523V2	170

MODEL	YEAR	ENGINE CODE	ENGINE SIZE	PART NO.	PAGE NO.
FORD CONTINUED					
KUGA	08-	G6DB/G, TXDA, UFDA, UKDA	2.0TDCI	07752700	172
MONDEO	93-	L1F, L1J, L1L, L1N, L1Q	1.6 16V ZETEC-E	077523V2	170
MONDEO	07-	KGBA, PNBA, RHBA,	1.6 TI VCT	07752600	171
MONDEO	11-	T1BA, T1BB, T1BC	1.6D TDCI	07763900	175
MONDEO	93-	RKA,RKB, RKF, RKJ, RKH, RKK	1.8 16V ZETEC SEFI	077523V2	170
MONDEO	01-	CDBB, CGBA/B, CHBA/B	1.8	077523V2	170
MONDEO	03-05	CFBA	1.8 SCI 16V	07764400	171
MONDEO	93-	RFM, RFN	1.8D TCI	07752700	172
MONDEO	07-	FFBA, KHBA, QYBA	1.8D TDCI	07752500	173
MONDEO	93-96	NGA, NGB, NGC, NGD	2.0 ZETEC-E SEFI	077523V2	170
MONDEO	00-07	CJBA, CJBB	2.0	077523V2	170
MONDEO	07-	AOBA/C, TBBA/B	2.0 16V	077523V2	170
MONDEO	00-	FMBA/B, HJBAB/C/E, N7BA/B, SDBA	2.0D DURATORQ TDCI	07752200	175
MONDEO	07-	AZBA/C, QXBA/B, KLBA, LPBA, TXBA, TYBA, UFBA, UKBA,	2.0D DURATORQ TDCI	07752700	172
MONDEO	00-	D5BA, D6BA	2.0D DURATORQ TDDI	07752700	172
MONDEO	04-	QJBA/B/C/D	2.2D TDCI	07752700	172
MONDEO	08-	Q4BA, KNBA/B	2.2D TDCI	07752800	174
MONDEO	07-	SEBA	2.3 16V	077523V2	170
PUMA	97-00	FHD, FHF, LIW, MHA, MHB	1.4/1.6/1.7	077523V2	170
RANGER	11-	AJQJ, AJPF, AJQW	2.2TDCI	07764500	162
RANGER	11-	SAFA	3.2TDCI	07764500	162
S MAX	11-	T1BA, T1BB	1.6TDCI	07763900	175
S MAX	06-	FFWA, QYWA	1.8 TDCI	07752500	173
S MAX	06-	AOWA/B, TBWA/B	2.0 FFV/PFI	077523V2	170
S MAX	06-	AZWA/C, KLWA, QXWA/B, TXWA, TYWA, UFWA, UKWA	2.0 TDCI	07752700	172
S MAX	08-	KNWA, Q4BA, Q4WA	2.2 TDCI	07752800	174
S MAX	07-	SEWA	2.3 16 V	077523V2	170
TRANSIT CONNECT	02-	EYPA, EYPC	1.8	077523V2	170
TRANSIT CONNECT	02-	BHPA	1.8D TDDI	07752500	173
TRANSIT CONNECT	02-	HCPA/B, RWPA/C, P7PA, P9PA, R2PA, R3PA, R9PB	1.8D TDCI	07752500	173
TRANSIT	00-06	ABFA, D3FA, F3FA, FIFA	2.0 DDI/TDCI	07752200	175
TRANSIT	02-06	D0FA, D2FA/B, D4FA, F4FA, F2FA	2.4D DURATORQ DDI	07752200	175
TRANSIT	04-	H9FA/B/D, JXFA/C, PHFA/C	2.4D DURATORQ TDCI	07752200	175
TRANSIT	06-	P8FA, P8FB, PGFA, PGFB, QVFA, QWFA, SRFA/B/C/D/E, DRFA/B/C, CYFA/B/C, UHFA	2.2 TDCI	07764500	162
TRANSIT	06-	GZFA, GZFB, GZFC	2.3 16V	077523V2	170
TRANSIT	07-	SAFA	3.2 DTDCI	07764500	162
IVECO					
DAILY	03-	F1AE0481A/B/D/F/G/H/R	2.3 JTD	07764500	176
ECO DAILY	09-	F1CE0481FA/GA/HA/RA/UA/VA	2.3 JTD	07764500	176
DAILY	96-	8140.47R/67F	2.5D	07751500	176
DAILY	01-06	8140.43B/C/N/S, 8140.63	2.8D	07751500	176
DAILY	04-	F1CE0441F, F1CE0481A/B/F/H	3.0 JTD	07764500	176



MODEL	YEAR	ENGINE CODE	ENGINE SIZE	PART NO.	PAGE NO.
JAGUAR					
S-TYPE	04-	276DT	2.7D	07754200	177
S-TYPE	99-	1B, GB, GC, HB	4.0/4.2/R	07763000	177
XF	11-	224DT	2.2D	07752800	177
XF	08-	7G	2.7D	07754200	177
XF	08-	1G, HB	4.2/SUPER	07763000	177
XJR	97-	DC, MA, MB, TB	4.0 V8/4.2	07763000	177
XJ6	05-	7G	2.7D TDVI	07754200	177
XJ8 / SOVEREIGN	97-	AC, KB, KC, RB	3.2/3.5	07763000	177
XJ8 / SOVEREIGN	97-	BC, DC, LB, LC, MA, MB, SB, TB	4.0/4.2	07763000	177
XK8	96-	2B, 5G, CC, CE, NB, NC	4.0/4.2	07763000	177
XKR	98-	3B,5G,9G,EC,PA,PB,PC	4.0/4.2	07763000	177
X-TYPE	03-	FMBA/B, BG, QJBA	2.0D/2.2D	07752200	178
JEEP					
CHEROKEE	01-	R2516K, R2816K4	2.5/2.8D CRD	07762000	155
LAND ROVER					
DEFENDER	06-11	244DT	2.4D TD4	07752200	181
DEFENDER	99-07	10P, 15P	2.5D TD5	07766000	180
DISCOVERY II	98-04	10P, 15P	2.5D TD5	07766000	180
DISCOVERY 3	04-	276DT	2.7D TDV6	07754200	181
DISCOVERY 3	04-	448PN	4.4	07763000	179
DISCOVERY 4	09-	276DT	2.7D TDV6	07754200	181
FREELANDER	97-	18K16, K18	1.8	02240000	179
FREELANDER	00-06	204D3/TD4	2.0D TD4	07759000	180
FREELANDER	00-06	KV6	2.5 V6	07761000	179
FREELANDER 2	06-	DW12/CTED	2.2 TDI	07752800	180
RANGE ROVER	02-06	TD6	3.0D	07759000	180
RANGE ROVER	05-	428PS, 448PN	4.2/4.4	07763000	179
RANGE ROVER EVOQUE	11-	DW12	2.2D	07752800	180
RANGE ROVER SPORT	05-	276DT	2.7TD	07754200	181
RANGE ROVER SPORT	05-	428PS, 448PN	4.2/4.4	07763000	179
LDV					
CONVOY	02-06	ZSD 424	2.4D TD	07752400	229
MAXUS	05-09	VMR	2.5 CRD	07762000	155
LEXUS					
IS200D/IS220D	05-	2AD-FTV, 2AD-FHV	2.2D	07764800	217
MAZDA					
2	03-07	FUJA/B, F8JA/B	1.25	077523V2	182
2	02-07	FXJA, FXJB	1.4	077523V2	182
2	02-	F6JA, F6JB	1.4 TDCI	07763900	182
2	02-07	FYJA	1.6	077523V2	182
2	08-	MZ-CD/ Y6	1.6D	07763900	182
3	04-	Y6	1.6D	07763900	182
3	03-	LF	2.0	077523V2	182
3	09-	LF	2.0 DISI	07764400	182
3	06-	L3 TURBO	2.3 MPS	07764400	182
5	10-	MZ-CD 1.6	1.6D	07763900	182
5	05-	L8, MRZ 1.8	1.8 (AUTO)	077523V2	182
5	05-	LF	2.0	07764400	182
5	10-	MRZ 2.0	2.0 (AUTO)	077523V2	182
6	02-	L8, LF, L3	1.8/2.0/2.3	077523V2	182
6	10-	LF	2.0 DISI	07764400	182
121	95-00	DHA	1.25	077523V2	182
121	95-97	RTJ	1.8D	07752700	172
CX-7	07-	L3 F	2.3	07764400	182
MPV	02-	L3	2.3	077523V2	182
MX-5	05-	L8	1.8	077523V2	182

MODEL	YEAR	ENGINE CODE	ENGINE SIZE	PART NO.	PAGE NO.
MAZDA CONTINUED					
MX-5	05-	LF	2.0	077523V2	182
TRIBUTE	01-	YF	2.0	077523V2	182
TRIBUTE	04-	L3	2.3	077523V2	182
MERCEDES					
C-CLASS 180 (202)	93-00	111.920/1	1.8	07760000	184
C-CLASS 180/200 (202)	93-03	111.941/44/45/52/56	2.0	07760000	184
C-CLASS 200 (202)	93-97	601.913/604.910/915	2.0/2.2D	07760000	184
C-CLASS 200/220 (202)	98-00	611.960	2.2 CDI	07760000	184
C-CLASS 220 (202)	93-97	111.961	2.2	07760000	184
C-CLASS 230/K (202)	96-00	111.974/75	2.3	07760000	184
C-CLASS 240 (202)	98-	112.910/15	2.4/2.6	07765000	183
C-CLASS 250 (202)	93-98	605.910/60	2.5D/DT	07760000	184
C-CLASS 280 (202)	93-97	104.941	2.8	07760000	184
C-CLASS 280 (202)	97-00	112.920	2.8	07765000	183
C-CLASS 180/200/K (203)	00-03	111.951/55	2.0	07760000	184
C-CLASS 200/220 (203)	03-08	646.962/63	2.1 CDI	07760000	184
C-CLASS 200/220 (203)	00-04	611.962	2.2 CDI	07760000	184
C-CLASS 230K (203)	01-03	111.981	2.3	07760000	184
C-CLASS 240 (203)	00-06	112.912/16	2.6	07765000	183
C-CLASS 270 (203)	00-06	612.962	2.7 CDI	07760000	184
C-CLASS 320 (203)	06-08	642.910	3.0 CDI	07760000	184
C-CLASS 320 (203)	00-06	112.946/53	3.2	07765000	183
C-CLASS 180/220/250 CGI (204)	09-	271.820/60	1.8	07760000	184
C-CLASS 200/220 (204)	07-10	646.811/12	2.1 CDI	07760000	184
C-CLASS 320/350 (204)	07-	642.830/32/960/61	3.0 CDI	07760000	184
CL 420/500/600 (140)	95-99	119.980/81/120.982	4.2/5.0/6.0	07760000	184
CL 500 (215)	99-07	113.960	5.0	07765000	183
CLC 200/220 (203)	08-	646.962/63	2.1CDI	07760000	184
CLK 200K/230/K (208)	98-03	111.944/45/56/75/82	2.0/2.3	07760000	184
CLK 320 (208)	97-03	112.940	3.2	07765000	183
CLK 430 (208)	98-03	113.943	4.3	07765000	183
CLK 220 (209)	05-09	646.963/66	2.1 CDI	07760000	184
CLK 240 (209)	02-06	112.912	2.6	07765000	183
CLK 270 (209)	02-06	612.967	2.7 CDI	07760000	184
CLK 320 (209)	05-09	642.910	3.0 CDI	07760000	184
CLK 320 (209)	02-05	111.946	3.2	07760000	184
CLK 320 (209)	02-06	112.955	3.2	07765000	183
CLS 500/55 AMG (209)	02-06	113.968/87	5.0/5.4	07765000	183
CLS 320/50 (219)	05-	642.920/22	3.0 CDI	07760000	184



MODEL	YEAR	ENGINE CODE	ENGINE SIZE	PART NO.	PAGE NO.
MERCEDES CONTINUED					
CLS 500/55AMG (219)	05-	113.967/90	5.0/5.4	07765000	183
E-CLASS 200/250 CGI (207)	09-	271.820/860	1.8	07760000	184
E-CLASS 200/K (210)	95-03	111.942/47/57	2.0	07760000	184
E-CLASS 200/220 (210)	96-97	604.912/17	2.0/2.2D	07760000	184
E-CLASS 200 (210)	99-03	611.961/62	2.2 CDI	07760000	184
E-CLASS 230 (210)	95-97	111.970	2.3	07760000	184
E-CLASS 240 (210)	98-03	112.911/14	2.4/2.6	07765000	183
E-CLASS 250 (210)	95-03	605.910/12/62	2.5D	07760000	184
E-CLASS 270 (210)	99-03	612.961	2.7 CDI	07760000	184
E-CLASS 280 (210)	95-97	104.945	2.8	07760000	184
E-CLASS 280 (210)	97-03	112.921	2.8	07765000	183
E-CLASS 290 (210)	95-98	602.982	2.9D	07760000	184
E-CLASS 300 (210)	95-97	606.912	3.0D	07760000	184
E-CLASS 320 (210)	95-97	104.995	3.2	07760000	184
E-CLASS 320 (210)	97-03	112.941	3.2	07765000	183
E-CLASS 320 (210)	99-03	613.961	3.2 CDI	07760000	184
E-CLASS 420 (210)	95-03	119.985	4.2	07760000	184
E-CLASS 430 (210)	98-03	113.940	4.3	07765000	183
E-CLASS 200/220 (211)	02-10	646.820/21/951/61	2.1 CDI	07760000	184
E-CLASS 240 (211)	02-05	112.913/17	2.6	07765000	183
E-CLASS 270 (211)	02-05	647.961	2.7 CDI	07760000	184
E-CLASS 280/300/320 (211)	05-10	642.920/21	3.0 CDI	07760000	184
E-CLASS 320 (211)	02-05	112.949/954	3.2	07765000	183
E-CLASS 280/320 (211)	02-05	648.961	3.2 CDI	07760000	184
E-CLASS 400 (211)	03-05	628.961	3.9 CDI	07760000	184
E-CLASS 420 (211)	05-10	629.910	4.0 CDI	07760000	184
E-CLASS 500/E55AMG (211)	02-06	113.967/69/90	5.0/5.4	07765000	183
E-CLASS 200/250 CGI (212)	09-	271.820/60	1.8	07760000	184
E-CLASS 200 CGI (212)	09-	271.860	1.8	07760000	184
E-CLASS 250 CGI (212)	09-	271.860	1.8	07760000	184
GL-320/350 (164)	06-	642.820/940	3.0 CDI	07760000	184
GL-420/450 (164)	06-	629.912	4.0 CDI	07760000	184
GLK 320/350 (204)	08-	642.832/961	3.0 CDI	07760000	184
M-CLASS ML230 (163)	98-02	111.977	2.3	07760000	184

MODEL	YEAR	ENGINE CODE	ENGINE SIZE	PART NO.	PAGE NO.
MERCEDES CONTINUED					
M-CLASS ML270 (163)	99-05	612.963	2.7 CDI	07760000	184
M-CLASS ML320/350 (163)	98-02	112.942/70	3.2/3.7	07765000	183
M-CLASS ML400 (163)	00-05	628.962/63	4.0 CDI	07760000	184
M-CLASS M L430/500/55 AMG (163)	98-05	113.942/65/81	4.3/5.0/5.4	07765000	183
M-CLASS ML280/300/20/50 (164)	05-	642.820/940	3.0 CDI	07760000	184
M-CLASS ML500 (164)	05-	113.964	5.0	07765000	183
S-CLASS 280/320 (140)	93-98	104.944/94	2.8/3.2	07760000	184
S-CLASS 300 (140)	96-98	606.961/2	3.0D	07760000	184
S-CLASS 350 (140)	93-98	603.971	3.5D	07760000	184
S-CLASS 400/420 (140)	93-98	119.970/71/80/81	4.2/5.0	07760000	184
S-CLASS 600 (140)	93-99	120.980/82	6.0	07760000	184
S-CLASS 280/320 (220)	98-03	112.922/944	2.8/3.2	07765000	183
S-CLASS 320 (220)	99-06	613/648.960	3.2 CDI	07760000	184
S-CLASS 350 (220)	02-06	112.972/75	3.7	07765000	183
S-CLASS 400 (220)	00-06	628.960	4.0 CDI	07760000	184
S-CLASS 430/500 (220)	98-06	113.941/48/60/66	4.3/5.0	07765000	183
S-CLASS 320/350 (221)	05-	642.930/32	3.0 CDI	07760000	184
S-CLASS 420/450 (221)	06-	629.911	4.0 CDI	07760000	184
SL 280/320 (129)	93-00	104.943/91	2.8/3.2	07760000	184
SL 280/320 (129)	98-02	112.923/43	2.8/3.2	07765000	183
SL 500 (129)	93-00	119.972/82	5.0	07760000	184
SL 500 (129)	98-02	113.961	5.0	07765000	183
SL 600 (129)	93-00	120.981/83	6.0	07760000	184
SL 350 (230)	02-07	112.973	3.7	07765000	183
SL 55 AMG (230)	02-08	113.963/92/95	5.0/5.4	07765000	183
SLK 200/K (170)	96-04	111.943/46/58/73/83	2.0/2.3	07760000	184
SLK 320K (170)	00-04	112.947	3.2	07765000	183
SLK 55 AMG (171)	04-	113.989	5.4	07765000	183
R-CLASS 500	05-	113.971	5.0	07765000	183
SPRINTER	99-06	611.981/87	2.2 CDI	07760000	184
SPRINTER	95-00	601.943	2.3D	07760000	184
SPRINTER	95-06	111.979/84	2.3	07760000	184
SPRINTER	99-06	612.981	2.7 CDI	07760000	184
SPRINTER	97-00	602.980	2.9D	07760000	184
SPRINTER (906)	06-	646.984/86/89/90	2.1 CDI	07760000	184
V-CLASS	96-03	111.948/50/79/80	2.0/2.3	07760000	184
V-CLASS	99-03	611.980	2.2 CDI	07760000	184
V-CLASS	96-00	601.970	2.3D	07760000	184
VIANO 2.0/2.2	03-	646.980/84/89	2.1 CDI	07760000	184
VIANO 2.8	05-	642.990	2.8 CDI	07760000	184
VIANO 3.0/3.2/3.5	03-08	112.951/76	3.2/3.7	07765000	183



MODEL	YEAR	ENGINE CODE	ENGINE SIZE	PART NO.	PAGE NO.
MERCEDES CONTINUED					
VARIO (667/668/670)	96-06	602.984/85	2.9D	07760000	184
VITO (638)	95-03	111.948/50	2.0	07760000	184
VITO (638)	99-03	611.980	2.2 CDI	07760000	184
VITO (638)	95-03	111.978/80	2.3	07760000	184
VITO (638)	96-00	601.942/70	2.3D	07760000	184
VITO (639)	03-	646.980/1/2/3/4/9	2.1 CDI	07760000	184
VITO (639)	06-10	642.990	3.0 CDI	07760000	184
VITO (639)	03-08	112.951/76	3.2	07765000	183
MINI					
ONE (R50/52/53)	01-	W10 B16AA	1.6	07758300	185
COOPER (R50/52/53)	01-09	W10 B16BA, W11 B16AA	1.6	07758300	185
ONE (R56/57)	07-	N12 B14/AB	1.4	07758600	186
COOPER (R56/57)	06-	N12 B16A, N16 B16MO	1.6	07758600	186
COOPER S (R56/57)	06-	N14 B16A	1.6	07758600	186
JWC (R56/57)	08-	N14 B16CD	1.6	07758600	186
ONE/FIRST (R56/57)	10-	N16 B16/UO/KO	1.6	07758600	186
COOPER D (R56/57)	07-	W16 D16(9HZ)	1.6D	07759300	186
COOPER D (R56/57)	10-	N47 C16U1	1.6D	07758900	187
ONE D (R56/57)	09-	W16 D16UO	1.6D	07759300	186
ONE D (R56/57)	10-	N47 C16K1	1.6D	07758900	187
COOPER D (R56/57)	11-	N47 C20K1	2.0D	07758900	187
COOPER SD (R56/57)	11-	N47 C20U1	2.0D	07758900	187
COUPE COOPER (58)	11-	N16 B16A/MO	1.6	07758600	186
COUPE COOPER SD (58)	11-	N47 C20U1	2.0D	07758900	187
ROADSTER COOPER (59)	12-	N16 B16MO	1.6	07758600	186
ROADSTER COOPER SD (59)	12-	N47 C20U1	2.0D	07758900	187
CLUBMAN ONE (R55)	08-	N12 B14AB	1.4	07758600	186
CLUBMAN COOPER (R55)	07-	N12 B16A	1.6	07758600	186
CLUBMAN COOPER (R55)	10-	N16 B16MO	1.6	07758600	186
CLUBMAN COOPER S (R55)	07-	N14 B16A	1.6	07758600	186
CLUBMAN JCW (R55)	08-	N14 B16CD	1.6	07758600	186
CLUBMAN ONE (R55)	10-	N16 B16UO	1.6	07758600	186
CLUBMAN COOPER D (R55)	07-	W16 D16(9HZ)	1.6D	07759300	186
CLUBMAN COOPER D (R55)	10-	N47 C16U1	1.6D	07758900	187
CLUBMAN ONE D (R55)	10-	N47 C16K1	1.6D	07758900	187
CLUBMAN COOPER D (R55)	11-	N47 C20K1	2.0D	07758900	187
CLUBMAN COOPER SD (R55)	11-	N47 C20U1	2.0D	07758900	187

MODEL	YEAR	ENGINE CODE	ENGINE SIZE	PART NO.	PAGE NO.
MINI CONTINUED					
COUNTRYMAN COOPER (R60)	10-	N16 B16MO	1.6	07759400	185
COUNTRYMAN ONE (R60)	10-	N16 B16UO	1.6	07759400	185
COUNTRYMAN COPPER D (R60)	10-	N47 C16U1	1.6D	07758900	187
COUNTRYMAN ONE D (R60)	10-	N47 C16K1	1.6D	07758900	187
COUNTRYMAN COOPER D (R60)	11-	N47 C20K1	2.0D	07758900	187
COUNTRYMAN COOPER SD (R60)	11-	N47 C20U1	2.0D	07758900	187
NISSAN					
ALMERA (N16)	02-	K9K	1.5D DCI	07755700	188
ALMERA (N16)	00-	YD22DDT/I	2.2 DDCI/DI	07764900	189
ALMERA TINO	03-	YD22DDT/I	2.2 DDCI/DI	07764900	189
CABSTAR	06-	YD25DDT/I	2.5D	07764900	189
CUBE	09-	K9K	1.5 DCI	07755700	188
EVALIA	09-	K9K	1.5DCI	07755700	188
JUKE	10-	K9K	1.5DCI	07755700	188
INTERSTAR	02-	F9Q 772/774	1.9D DCI	07755200	188
INTERSTAR	02-	G9T 722/750	2.2D DCI	07755200	188
INTERSTAR	02-	G9U 632/650/720/724/726/750/754	2.5D DCI	07755200	188
KUBISTAR	03-06	D7F 726	1.2	07755700	188
KUBISTAR	03-09	D4F 712	1.2 16V	07755700	188
KUBISTAR	03-	K9K 702/704/710/714/716/718	1.5 DCI	07755700	188
KUBISTAR	03-	K4M 752/753	1.6	07755100	188
MICRA (K12)	03-	K9K	1.5 DCI	07755700	188
NAVARA PICK UP	02-	YD25DDTI	2.5D DCI	07764900	189
NOTE	06-	K9K	1.5 DCI	07755700	188
NV200	09-	K9K	1.5 DCI	07755700	188
PATHFINDER	04-	YD25DDTI	2.5D DCI	07764900	189
PRIMERA (P12)	03-07	F9Q	1.9D DCI	07755200	188
PRIMERA (P12)	02-	YD22DDTI	2.2 DDCI/DI	07764900	189
PRIMASTAR	02-	F9Q760/762	1.9 DCI	07755200	188
PRIMASTAR	02-	F4R720/722/820	2.0	07755100	188
PRIMASTAR	08-	M9R780/782/784	2.0 DCI	07755500	189
PRIMASTAR	03-	G9U 630/730	2.5 DCI	07755200	188
QASHQAI	07-	K9K	1.5 DCI	07755700	188
QASHQAI	07-	M9R	2.0 DCI	07755500	189
TIIDA	07-	K9K	1.5 DCI	07755700	188
X-TRAIL (T30)	01-	YD22DDTI/DCI	2.2 DDI	07764900	189
X-TRAIL (T31)	07-	M9R	2.0 DCI	07755500	189
OPEL /GM					
ADAM	12-	A12XEL (LWD)	1.2 16V	07763500	190
ADAM	12-	A14XEL, A14XER	1.4 16V	07763500	190
AGILA	00-	Z10XE/XEP	1.0 12V	07753200	190
AGILA	00-	Z12XE/XEP	1.2 16V	07753200	190
AGILA	04-	Z13DT	1.3 DTI	07761900	193
AGILA B	08-	D13A, Z13DTJ	1.3 CDTI	07751800	193
AMPERA	11-	A14XEL	1.4	07763500	190
ANTARA	06-	Z20DM/H	2.0D	07753800	194
ANTARA	06-	Z32SE	3.2	07753500	192
ASTRA-G	00-	Z12XE	1.2 16V	07753200	190
ASTRA-G	98-	X14XE, Z14XE	1.4 16V	07764600	191
ASTRA-G	03-	Z14XEP	1.4 16V	07753200	190
ASTRA-G	98-	X16SZR, X16XEL, Z16XE, Z16SE, Y16XE, Z16YNG	1.6	07764600	191

MODEL	YEAR	ENGINE CODE	ENGINE SIZE	PART NO.	PAGE NO.
OPEL / GM CONTINUED					
ASTRA-G	98-	Y16XE, Z16YNG	1.6	07764600	191
ASTRA-G	03-	Z16XEP	1.6	07753900	191
ASTRA-G	98-	X18XE1, Z18XE, Z18XEL	1.8 16V	07764600	191
ASTRA-G	98-	X20XE	2.0 16V	02290000	191
ASTRA-G	98-	X20DTL, Y20DTH, Y20DTL	2.0 D/DT	07753300	194
ASTRA-G	00-	Z20LET	2.0T	02290000	191
ASTRA-G	00-	Z22SE	2.2 SRI	07753700	192
ASTRA-G	00-	Y22DTR	2.2D DTI	07753300	194
ASTRA H	05-	Z12XEP	1.2	07753200	190
ASTRA H	05-	Z13DTH	1.3CDTI	07751800	193
ASTRA H	04-	Z14XEL, Z14XEP	1.4 TWINPORT	07753200	190
ASTRA H	04-	Z16LET/XEP/XER/XE1	1.6 TWINPORT	07753900	191
ASTRA H	04-	Z18XE	1.8L	07764600	191
ASTRA H	05-	A18XER, Z18XER	1.8L	07753900	191
ASTRA H	04-	Z19DT/H/J/L	1.9 DCDTI	07764700	194
ASTRA H	04-	Z20LEH/LEL/LER	2.0 VXR	02290000	191
ASTRA H	04-	Z22YH	2.2	07753700	192
ASTRA J	09-	A13DTE	1.3D CDTI	07751800	193
ASTRA J	09-	A14NEL/NET/XER/XEL	1.4	07763500	190
ASTRA J/ECO	09-	A16LET, A16XER	1.6 16V	07753900	191
ASTRA J	09-	A20DTH	2.0D CDTI	07764700	194
COMBO	04-	Z12XEP	1.2 16V	07753200	190
COMBO	03-	Z13DT, Z13DTJ	1.3D CDTI	07761900	193
COMBO	03-	Z14XEP	1.4	07753200	190
COMBO	01-	Z16SE, Z16YNG	1.6 8V	07764600	191
CORSA-B	97-00	X10XE, X12XE	1.0/1.2	07753200	190
CORSA-B	94-00	X14XE	1.4	07764600	191
CORSA-C	00-	Z10XE, Z10XEP	1.0 12V	07753200	190
CORSA-C	00-	Z12XE, Z12XEP	1.2 16V	07753200	190
CORSA-C	03-	Z13DT	1.3 CDTI	07751800	193
CORSA-C	00-	Z14XE	1.4 16V	07764600	191
CORSA-C	03-	Z14XEP	1.4 TWINPORT	07753200	190
CORSA-C	00-	Z16SE, Z16YNG	1.6 8V	07764600	191
CORSA-C	00-	Z18XE	1.8 16V	07764600	191
CORSA-D	06-	Z10XE, Z10XEP	1.0	07753200	190
CORSA-D	09-	A10XEP	1.0 ECO	07763500	190
CORSA-D	06-	Z12XEP	1.2	07753200	190
CORSA-D	09-	A12XEL, A12XER	1.2	07763500	190
CORSA-D	06-	Z13DTE/H/J/R	1.3D CDTI	07751800	193
CORSA-D	10-	A13DTC/E/R	1.3D CDTI	07751800	193
CORSA-D	06-	Z14XEP	1.4	07753200	190
CORSA-D	09-	A14NEL, A14XEL, A14XER	1.4	07763500	190
CORSA-D	07-	Z16LER, Z16LEL, A16LEL, A16LER	1.6/SRI/VXR	07753900	191
FRONTERA-A	95-98	X22XE	2.2 16V	02290000	191
FRONTERA-B	98-	X22DTH, Y22DTH	2.2 DT	07753300	194
FRONTERA-B	98-	X22SE, Y22SE	2.2	02290000	191
INSIGNIA	11-	A14NET	1.4	07763500	190
INSIGNIA	08-	A16XER, A16LET	1.6	07753900	191
INSIGNIA	08-	A18XER	1.8	07753900	191
INSIGNIA	08-	A20DT/C/H/J/L	2.0D CDTI	07764700	194
MERIVA	04-	Z13DT, Z13DTJ	1.3D CDTI	07751800	193
MERIVA	04-	Z14XEP	1.4	07753200	190
MERIVA	03-	Z16SE, Z16XE	1.6	07764600	191
MERIVA	06-	Z16XEP	1.6 16V	07753900	191
MERIVA	03-	Z18XE	1.8 16V	07764600	191
MERIVA B	10-	A13DTC, A13DTE	1.3D CDTI	07751800	193
MERIVA B	10-	A14NEL, A14NER, A14NET	1.4 16V	07763500	190

MODEL	YEAR	ENGINE CODE	ENGINE SIZE	PART NO.	PAGE NO.
OPEL / GM CONTINUED					
MOKKA	12-	A14NET	1.4 16V	07763500	190
MOKKA	12-	A16XER	1.6 16V	07753900	191
MOVANO	00-	F9Q 772/774	1.9 DTI	07755200	195
MOVANO	00-	G9T 720/722/750	2.2D DTI	07755200	195
MOVANO	00-03	G9U A720/724	2.5D DTI	07755200	195
MOVANO	06-	G9U 632/650/726/750/754	2.5D CDTI	07755200	195
MOVANO	98-03	S9W 700/702	2.8DT	07751500	195
MOVANO B	10-	M9T 670/72/76/78/80/90/92/94/96/98	2.3DCDTI	07755500	193
OMEGA-B	94-	X20XE	2.0 16V	02290000	191
OMEGA-B	97-	X20DTH	2.0D DTI	07753300	194
OMEGA-B	00-	Y22DTH	2.2 DTI	07753300	194
OMEGA-B	94-	Z5DT, X25DT, Y25DT	2.5DTI	07758000	148
OMEGA-B	99-	Y22XE, Z22XE	2.2 16V	02290000	191
OMEGA-B	94-00	X25XE	2.5 V6 24V	07753500	192
OMEGA-B	00-03	Y26SE	2.6 V6	07753500	192
OMEGA-B	94-01	X30XE	3.0 V6 24V	07753500	192
OMEGA-B	01-03	Y32SE	3.2 V6	07753500	192
SIGNUM	03-	Z18XE	1.8	07764600	191
SIGNUM	06-	Z18XER	1.8	07753900	191
SIGNUM	04-	Z19DT/DTH/DTL	1.9D CDTI	07764700	194
SIGNUM	03-	Y20DTH	2.0D DTI	07753300	194
SIGNUM	03-	Z22YH	2.2L	07753700	192
SIGNUM	03-	Y22DTR	2.2D DTI	07753300	194
SIGNUM	03-05	Z32SE	3.2 V6	07753500	192
SINTRA	97-99	X22DTH	2.2 DIESEL	07753300	194
SINTRA	96-99	X22XE	2.2	02290000	191
SINTRA	96-99	X30XE	3.0	07753500	192
SPEEDSTER	03-	Z20LET	2.0	02290000	191
SPEEDSTER	00-	Z22SE	VX220	07753700	192
TIGRA	94-00	X14XE	1.4	07764600	191
TIGRA B	04-	Z13DT	1.3 CDTI	07761900	193
TIGRA B	04-	Z14XEP	1.4	07753200	190
TIGRA B	04-	Z18XE	1.8	07764600	191
VECTRA-A	94-95	X20XE	2.0 16V	02290000	191
VECTRA-A	93-95	C25XE	2.5V6 24V	07753500	192
VECTRA-B	96-	X16SZR/XE1/XEL, Y16XE, Z16XE	1.6	07764600	191
VECTRA-B	96-	X18XE	1.8 16V	02290000	191
VECTRA-B	96-	X18XE1, Z18XE, Z18XEL	1.8	07764600	191
VECTRA-B	97-	C20SEL, X20XE	2.0 16V	02290000	191
VECTRA-B	97-	X20DTH, X20DTL, Y20DTH	2.0 DIESEL	07753300	194
VECTRA-B	00-	Z22SE	2.2 SRI	07753700	192
VECTRA-B	00-	Y22DTR	2.2 DTI	07753300	194
VECTRA-B	96-	X25XE	2.5 V6	07753500	192
VECTRA-B	00-	Y26SE	2.6	07753500	192
VECTRA-C	02-	Z16XE	1.6	07764600	191
VECTRA-C	06-	Z16XEP	1.6	07753900	191
VECTRA-C	02-	Z18XEL	1.8	07764600	191
VECTRA-C	06-	Z18XER	1.8	07753900	191
VECTRA-C	02-	Z18XE	1.8	07764600	191
VECTRA-C	04-	Z19DT/DTH/DTL	1.9D CDTI	07764700	194
VECTRA-C	02-05	Y20DTH	2.0D DTI	07753300	194
VECTRA-C	02-	Z22YH, Z22SE	2.2	07753700	192
VECTRA-C	02-05	Y22DTR	2.2D DTI	07753300	194
VECTRA-C	02-05	Z32SE	3.2 V6	07753500	192
VIVARO	01-	F9Q760/762	1.9 CTDI	07755200	195
VIVARO	01-	F4R720/722/820	2.0	07755100	192



MODEL	YEAR	ENGINE CODE	ENGINE SIZE	PART NO.	PAGE NO.
OPEL / GM CONTINUED					
VIVARO	06-	M9R 630/780/782/784/ 786/788	2.0D CDTI	07755500	193
VIVARO	07-	G9U 630/730	2.5D DTI	07755200	195
ZAFIRA	99-	X16XEL, Z16XE, Z16YNG	1.6 16V	07764600	191
ZAFIRA	99-	X18XE1, Z18XE	1.8 16V	07764600	191
ZAFIRA	00-05	Z20LET	2.0T	02290000	191
ZAFIRA	99-	X20DTL, Y20DTL, Y20DTH	2.0 DI/DTI	07753300	194
ZAFIRA	00-05	Z22SE	2.2 16V	07753700	192
ZAFIRA	02-05	Y22DTR	2.2 DTI	07753300	194
ZAFIRA B	06-	Z13DTH	1.3D CDTI	07761900	193
ZAFIRA B	06-	Z16YNG	1.6	07764600	191
ZAFIRA B	05-	Z16XEP/XE1/XER/XNT	1.6	07753900	191
ZAFIRA B	09-	A16XER, A16XNT	1.6	07753900	191
ZAFIRA B	05-	Z18XER, A18XER	1.8	07753900	191
ZAFIRA B	05-	Z19DT/DTH/DTL	1.9 CDTI	07764700	194
ZAFIRA B	05-	Z20LEH/LEL/LER	2.0T	02290000	191
ZAFIRA B	05-	Z22YH	2.2	07753700	192
ZAFIRA C	11-	A14 NEL, A14NET	1.4	07763500	190
PEUGEOT					
106	91-	CDY, CDZ	1.0	07754300	198
106	91-	HDY, HDZ, HFX	1.1	07754300	198
106	91-	KDY, KDX, KFW, KFX, KFZ	1.4	07754300	198
106	94-	VJY, VJZ	1.5D	07754400	200
106	94-	NFW, NFY, NFX, NFZ	1.6	07754300	198
107	05-	8HT	1.4D HDI	07763900	199
1007	05-	KFU, KFV, KFW	1.4 (75)	07754500	196
1007	05-	8HX, 8HZ	1.4 HDI (68)	07763900	199
1007	05-	NFU	1.6 16V (109)	07754300	198
1007	06-	9HZ	1.6 HDI (9HZ)	07763900	199
206	98-05	HFY, HFX, HFZ	1.1	07754300	198
206	98-	KFU, KFW	1.4	07754500	196
206	98-	KFX	1.4	07754300	198
206	01-	8HX, 8HZ	1.4 HDI	07763900	199
206	98-02	NFU, NFZ	1.6	07754300	198
206	04-	9HY, 9HX, 9HZ	1.6 HDI	07763900	199
206	99-04	WJY, WJZ	1.9D	07754400	200
206	98-	RFK, RFN, RFR	2.0	07754100	199
206	99-	RHY	2.0 HDI	07764000	201
206 +	09-	HFX	1.1	07754300	198
206 +	09-	KFW	1.4	07754500	196
206 +	09-	8HR, 8HZ	1.4 HDI	07763900	199
206CC	00-	NFU	1.6	07754300	198
206CC	05-	9HZ	1.6D HDI	07763900	199
206CC	00-	RFN	2.0	07754100	199
207	06-	KFU, KFV	1.4	07754500	196
207	07-	EP3/C (8FP, 8FS)	1.4 VTI	07759400	196
207	06-	8HR, 8HZ	1.4D HDI	07763900	199
207	06-	NFU	1.6	07754300	198
207	06-	EP6DT (5FR,5FX)	1.6 GT THP	07759500	197
207	06-	EP6DTS (5FY)	1.6 GTI THP	07758600	197
207	07-	EP6C (5FS,5FW)	1.6 VTI	07759400	196
207	06-	9HP, 9HR, 9HV, 9HX, 9HY, 9HZ	1.6D HDI	07763900	199
207CC	07-	EP6DT (5FR,5FX)	1.6 THP	07759500	197
207CC	07-	EP6C (5FS,5FW)	1.6 VTI	07759400	196
207CC	07-	9HR, 9HZ	1.6D HDI	07759500	197
208	12-	8FP, 8FN	1.4 VTI	07759400	196
208	12-	8HP, 8HR	1.4D HDI	07763900	199

MODEL	YEAR	ENGINE CODE	ENGINE SIZE	PART NO.	PAGE NO.
PEUGEOT CONTINUED					
208	12-	EP6C (5FS)	1.6 VTI	07759400	196
208	12-	9HD, 9HP, 9HR	1.6D HDI	07763900	199
306	93-99	HDY, HDZ	1.1	07754300	198
306	93-02	KDX, KDZ, KFW, KFX	1.4	07754300	198
306	93-03	NFT, NFZ	1.6	07754300	198
306	93-	LFY, LFZ	1.8	07754300	198
306	93-00	A9A	1.8D	07754400	200
306	93-	D8A, D9B, DHY, DJY, DJZ	1.9D	07754400	200
306	93-	RFS, RFT, RFY, RFX	2.0	07754300	198
306	99-02	RHY	2.0 HDI	07764000	201
307	00-	KFU, KFW	1.4	07754500	196
307	01-	8HX, 8HZ	1.4 HDI	07763900	199
307	01-	NFU	1.6	07754300	198
307	04-	9HV, 9HX, 9HY, 9HZ	1.6D HDI	07763900	199
307	04-	RFK, RFJ, RFN	2.0 16V	07754100	199
307	00-	RHR, RHS, RHY, RHZ	2.0 HDI	07764000	201
307CC	04-	NFU	1.6	07754300	198
307CC	03-	RFJ, RFK, RFN	2.0	07754100	199
307CC	05-	RHR	2.0 HDI	07764000	201
308	07-	EP3C (8FR,8FS)	1.4 VTI	07759400	196
308	07-	NFU	1.6	07754300	198
308	07-	EP6DTS (5FT,5FU,5FV,5FY,5FX)	1.6 GT THP	07759500	197
308	07-	EP6C (5FS,5FW)	1.6 VTI	07759400	196
308	07-	9HP, 9HR, 9HV, 9HX, 9HY, 9HZ	1.6 HDI	07763900	199
308	08-	RFJ	2.0 BIO	07754100	199
308	07-	RHD, RHE, RHF, RHH, RHR	2.0 HDI	07764000	201
308 CC	07-	EP6DT (5FT,5FU,5FV,5FX)	1.6 THP	07759500	197
308 CC	09-	EP6C (5FS,5FW)	1.6 VTI	07759400	196
308 CC	09-	9HR, 9HZ	1.6 HDI	07763900	199
308 CC	09-	RHF, RHH, RHR	2.0 HDI	07764000	201
406	95-99	BFZ	1.6	07754300	198
406	97-02	LFY, LFX	1.8	07754300	198
406	00-04	6FZ	1.8 16V	07754100	199
406	96-00	D8B, DHW, DHX	1.9TD	07754400	200
406	00-04	RFN, RFR, RLZ	2.0 16V	07754100	199
406	96-02	RFV, RGX	2.0 16V	07754300	198
406	01-04	RHS, RHY, RHZ	2.0 HDI	07764000	201
406	96-00	P8C	2.1 TD	07754400	200
406	00-04	3FZ	2.2	07754100	199
406	00-06	4HX, 4HZ	2.2 HDI	07764000	201
407	04-	9HY, 9HZ	1.6 HDI	07763900	199
407	04-	6FY, 6FZ	1.8	07754100	199
407	04-	RFJ, RFN	2.0	07754100	199
407	04-	RHF, RHH, RHL, RHR	2.0 HDI	07764000	201
407	05-	4HP, 4HT	2.2 HDI	07764000	201
407	04-	3FY, 3FZ	2.2	07754100	199
407	04-	UHZ	2.7 HDI	07754200	200
508	11-	EP6CDT (5FN,5FV)	1.6 THP	07759500	197
508	11-	EP6C (5FH,5FS)	1.6 VTI	07759400	196
508	11-	9HL, 9HR	1.6 HDI	07763900	199
508	11-	RHC, RHD, RHF, RHH, RHR	2.0 HDI/HBRID	07764000	201
508	11-	4HL	2.2D GT HDI	07764000	201
605	89-99	R5A, RFV, RFZ, RGY, RGX	2.0	07754300	198
605	89-99	P8C, P9A, PHZ, THY	2.1D	07754400	200
607	00-	RFN, RFR	2.0	07754100	199
607	00-	RHL, RHR, RHS, RHZ	2.0 HDI	07764000	201

MODEL	YEAR	ENGINE CODE	ENGINE SIZE	PART NO.	PAGE NO.
PEUGEOT CONTINUED					
607	00-	3FV, 3FZ	2.2 16V	07754100	199
607	00-	4HP, 4HT, 4HX	2.2 HDI	07764000	201
607	04-	UHZ	2.7 HDI	07754200	200
806	95-02	LFW	1.8	07754300	198
806	95-00	D8B, DHX	1.9 TD	07754400	200
806	94-02	RFU	2.0	07754300	198
806	00-02	RFN	2.0 16V	07754100	199
806	94-02	RFV, RGX	2.0 16V	07754300	198
806	99-02	RHW, RHZ	2.0 (HDI) 16V	07764000	201
806	96-99	P8C	2.1TD	07754400	200
807	02-	RFJ, RFN	2.0 16V	07754100	199
807	02-	RHD, RHH, RHK, RHM, RHR, RHT, RHW	2.0 HDI FAP	07764000	201
807	02-	3FY, 3FZ	2.2	07754100	199
807	07-	4HP, 4HR, 4HS, 4HT, 4HW	2.2HDI/FAP	07764000	201
3008	09-	EP6DT (5FV,5FX)	1.6 THP	07759500	197
3008	09-	EP6C (5FS,5FW)	1.6 VTI	07759400	196
3008	09-	9HR, 9HZ	1.6 HDI	07763900	199
3008	09-	RHC, RHE, RHH	2.0 DHY	07764000	201
4007	07-	4HK, 4HN	2.2 HDI	07764000	201
5008	09-	EP6CDT (5FV,5FX)	1.6 THP	07759500	197
5008	09-	EP6C (5FS,5FW)	1.6 VTI	07759400	196
5008	09-	9HR, 9HZ	1.6 HDI	07763900	199
5008	09-	RHE, RHH	2.0 HDI	07764000	201
BIPPER	07-	KFV	1.4	07754500	196
BIPPER	08-	8HS	1.4 HDI	07763900	199
BOXER I	94-02	D8C, D9B, DHX, DJY	1.9D/TD	07754400	200
BOXER I	94-02	RFW	2.0	07754300	198
BOXER I	94-02	T8A, T9A, THX, THZ	2.5D/DT/DTI	07754400	200
BOXER I	00-	8140.43S	2.8 HDI	07751500	205
BOXER II	02-	RHV, 4HY	2.0/2.2 HDI	07764000	201
BOXER II	02-	8140.43N, 8140.43S	2.8 HDI	07751500	205
BOXER III	06-	4HM, 4HU, 4HV	2.2 HDI	07764500	202
BOXER III	06-	F30DT, F30DTE	3.0 HDI	07764500	202
EXPERT	96-	D8B, D9B, DHX, WJY, WJZ	1.9D/TD	07754400	200
EXPERT	99-	RHW, RHX, RHZ	2.0 HDI	07764000	201
EXPERT	00-	RFN	2.0	07754100	199
EXPERT III	07-	9HU	1.6 HDI	07763900	199
EXPERT III	07-	RFH, RFJ	2.0	07754100	199
EXPERT III	07-	RHG, RHK, RHR	2.0 HDI	07764000	201
PARTNER	96-02	HDZ, HFX	1.1	07754300	198
PARTNER	98-02	KFX	1.4	07754300	198
PARTNER	00-11	KFW	1.4	07754500	196
PARTNER	00-09	NFU	1.6 16V	07754300	198
PARTNER	05-	9HW, 9HX	1.6 HDI	07763900	199
PARTNER	97-02	LFX	1.8	07754300	198
PARTNER	96-00	A9A	1.8D	07754400	200
PARTNER	96-00	D9B, DJY, WJY, WJZ	1.9D	07754400	200
PARTNER	00-	RHY	2.0 HDI	07764000	201
PARTNER	08-	NFU	1.6	07754300	198
PARTNER	09-	EP6C (5FK,5FS)	1.6 VTI	07759400	196
PARTNER	08-	9HJ, 9HL, 9HN, 9HP, 9HR, 9HS	1.6 HDI	07763900	199
PARTNER	08-	9HT, 9HV, 9HW, 9HX, 9HZ	1.6 HDI	07763900	199
RCZ	10-	EP6CDTX (5FU,5FV)	1.6 THP	07759500	197
RCZ	10-	RHH	2.0 HDI	07764000	201

MODEL	YEAR	ENGINE CODE	ENGINE SIZE	PART NO.	PAGE NO.
RENAULT					
AVANTIME	00-03	F4R 720/721	2.0 16VT	07755100	203
CLIO	91-98	F3P 710/712/714/755/758	1.8	07755700	204
CLIO	91-98	F8Q 730/732	1.9D (LUCUS)	07755700	204
CLIO 2	98-	D7F 720/722/726/744/746/764	1.2	07764200	203
CLIO 2	01-	D4F 706/712/714/722/728	1.2 16V	07764200	203
CLIO 2	99-	K4J 700/10/11/12/13/15	1.4 16V	07755100	203
CLIO 2	01-	K9K 700/02/04/06/10/12/14/16/18	1.5 DCI	07755700	204
CLIO 2	98-03	K7M 744/745	1.6	07755700	204
CLIO 2	01-05	K4M 708/32/34/40/42/43/44/ 45/46/48	1.6 16V	07755100	203
CLIO 2	99-03	F8Q 630/632/662/780/782	1.9D/DTI	07755700	204
CLIO 2	00-04	F4R 730/732	2.0 16V	07755100	203
CLIO 3	05-	D4F 740/742/764/784	1.2/T	07755700	204
CLIO 3	05-	K4J 780	1.4	07755100	203
CLIO 3	05-	K9K 764/766/768	1.5D DCI	07755700	204
CLIO 3	05-	K4M 800/801/862	1.6	07755100	203
CLIO 3	06-	F4R 830/832	2.0	07755100	203
ESPACE	99-02	F9Q 720/722	1.9DT	07755700	204
ESPACE	96-00	F3R 728/729/742/768/769	2.0	07755700	204
ESPACE	98-02	F4R 700/701	2.0 16V	07755100	203
ESPACE	00-02	G9T 710	2.2 DCI	07755200	204
ESPACE IV	02-	F9Q 820/826/680	1.9D DCI	07755200	204
ESPACE IV	02-	F4R 790/791/792	2.0	07755100	203
ESPACE IV	06-	M9R 740/760/761	2.0 DCI	07755500	205
ESPACE IV	02-	F4RT 794/795/796/797/896/897	2.0T	07755100	203
ESPACE IV	02-	G9T 642/645/742/743	2.2D DCI	07755200	204
KANGOO	98-05	D7F 710/720/722/726/744/746/764/766	1.2	07764200	203
KANGOO	02-	D4F 712/714/716/730	1.2 16V	07764200	203
KANGOO	00-	K9K 700/702/704/710/714/716/718	1.5 DCI	07755700	204
KANGOO	01-09	K4M 708/730/732/750/752/753	1.6 16V	07755100	203
KANGOO	98-04	F8Q 630/632/662	1.9D	07755700	204
KANGOO	01-05	F9Q 790	1.9 DCI	07755200	204
KANGOO	99-01	F9Q 780/782	1.9 DTI	07755700	204
KANGOO II	08-	K9K 800/802/804/806/808	1.5 DCI	07755700	204
KANGOO II	08-	K7M 850	1.6	07755700	204
KANGOO II	08-	K4M 830/831/834	1.6 16V	07755100	203
KOLEOS	08-	M9R830/832/833	2.0 DCIF	07755500	205
LAGUNA 1	97-01	K4M 720/4	1.6 16V	07755100	203
LAGUNA 1	94-01	F3P 720/724/670/674/678	1.8	07755700	204
LAGUNA 1	98-01	F4P 760	1.8 16V	07755100	203
LAGUNA 1	98-01	F3P 676	1.8	07755700	204
LAGUNA 1	99-01	F9Q 718/754	1.9 DCI	07755200	204
LAGUNA 1	99-01	F9Q 710/716/717	1.9 DTI	07755700	204
LAGUNA 1	93-01	F3R 722/723/728/729/611/768/769	2.0	07755700	204
LAGUNA 1	99-01	F4R 780	2.0 16V	07755100	203
LAGUNA 2	02-	G9T 600/605/700/702/703/706/707	2.2 DCI	07755200	204

MODEL	YEAR	ENGINE CODE	ENGINE SIZE	PART NO.	PAGE NO.
RENAULT CONTINUED					
LAGUNA 2	01-07	K4M 710/711/714/716/718	1.6	07755100	203
LAGUNA 2	01-07	F4P 720/722/770/771/772/773/774/775	1.8	07755100	203
LAGUNA 2	01-07	F9Q 650/660/664/670/674/690/750/751/752/754/755/758/759	1.9 DCI	07755200	204
LAGUNA 2	01-07	F4R 712/713/714/715	2.0	07755100	203
LAGUNA 2	02-07	F4RT 764/765/784/786/787/886/887	2.0T	07755100	203
LAGUNA 2	05-07	M9R 740/760	2.0 DCI	07755500	205
LAGUNA 3	07-	K9K 782/790	1.5D DCI	07755700	204
LAGUNA 3	07-	K4M 824	1.6	07755100	203
LAGUNA 3	07-	M9R 742/800/802/805/808/814/815/820/845/849	2.0 DCI	07755500	205
LAGUNA 3	07-	F4RT 800802/810/811	2.0T/GT	07755100	203
LOGAN	04-	K4J 710	1.4	07755100	203
LOGAN	05-	K9K 790/792/794/796	1.5D DCI	07755700	204
LOGAN	04-	K7M 710	1.6	07755700	204
LOGAN	05-	K4M 690	1.6 16V	07755100	203
MEGANE	99-	K4J 714/750	1.4 16V	07755100	203
MEGANE	99-	K4M 700/701/704/706/708/709/712	1.6 16V	07755100	203
MEGANE	01-	F4P 720/722	1.8 16V	07755100	203
MEGANE	96-	F8Q 620/622/624/790/784/786	1.9D/DT	07755700	204
MEGANE	99-	F9Q 732/733	1.9 DCI	07755200	204
MEGANE	97-	F9Q 730/731/734/736/744	1.9 DTI	07755700	204
MEGANE	96-	F3R 750/51/52/91/96/97/98	2.0	07755700	204
MEGANE	99-	F4R 740/41/46	2.0 16V	07755100	203
MEGANE	96-99	F7R 710/714	2.0 16V	07755700	204
MEGANE II	02-09	K4J 730/732/740	1.4 16V	07755100	203
MEGANE II	02-	K9K 722/724/728/729/732/734	1.5D DCI	07755700	204
MEGANE II	02-	K4M 760/761/764/812/813	1.6	07755100	203
MEGANE II	02-	F9Q 800/803/804/808/814/818	1.9DCI	07755200	204
MEGANE II	02-	F4R 770/771	2.0 16V	07755100	203
MEGANE II	06-	M9R 700/721/722/724	2.0D DCI	07755500	205
MEGANE II	04-	F4RT 774/776	2.0	07755100	203
MEGANE III	08-	K9K 830/832/834/836	1.5D DCI	07755700	204
MEGANE III	08-	K4M 846/848/858/866	1.6	07755100	203
MEGANE III	08-	F9Q 870/872	1.9D DCI	07755700	204
MEGANE III	09-	M9R 610/613	2.0D GT DCI	07755500	205
MEGANE III	08-	F4RT 874	2.0 TCE/SPORT	07755100	203
MASTER	01-	F9Q 772/774	1.9DCI	07755200	204
MASTER	00-	F9Q 770	1.9DTI	07755700	204
MASTER	00-	G9T 720/722/750	2.2DCI	07755200	204
MASTER	10-	M9T 670/72/76/80/86/90/92/94/98	2.3DCI	07755500	205
MASTER	80-	S8U 720/22/30/31/42/48/50/52/70/72	2.5D	07751500	205
MASTER	91-	S9U 704/714	2.5TD	07751500	205
MASTER	06-	G9U 632/650/720/724/726/750/754	2.5DCI	07755200	204
MASTER	99-	S9W 206/208/212/700/702	2.8D DCI	07751500	205
MODUS GRAND	08-	K4M 791/800/801	1.6	07755100	203

MODEL	YEAR	ENGINE CODE	ENGINE SIZE	PART NO.	PAGE NO.
RENAULT CONTINUED					
MODUS GRAND	08-	K9K 764/766/768	1.5D DCI	07755700	204
MODUS GRAND	08-	K4M 791/800/801	1.6	07755100	203
SCENIC	99-03	K4J 714/750	1.4 16V	07755100	203
SCENIC	99-03	K4M 700/701/704/706/708/709/712	1.6 16V	07755100	203
SCENIC	00-03	F4P 720/722	1.8V 16V	07755100	203
SCENIC	99-03	F8Q 790	1.9D	07755700	204
SCENIC	00-	F9Q 732/733/740/748	1.9DCI/DTI	07755200	204
SCENIC	99-	F9Q 731/736/744	1.9DTI	07755700	204
SCENIC	00-03	F4R 740/741/744/746/747	2.0 16V	07755100	203
SCENIC II	03-07	K4J 730/740	1.4 16V	07755100	203
SCENIC II	03-	K9K 722/724/728/729/732/734/772/774	1.5D DCI	07755700	204
SCENIC II	03-	K4M 760/761/766/782/812/813/764	1.6 16V	07755100	203
SCENIC II	03-	F9Q 803/804/812/814/818	1.9 DCI	07755200	204
SCENIC II	03-	F4R 770/771	2.0 16V	07755100	203
SCENIC II	06-	M9R 700/721/722/724	2.0D DCI	07755500	205
SCENIC II	04-	F4RT 776	2.0T	07755100	203
SCENIC III	09-	K9K 830/832/836	1.5D DCI	07755700	204
SCENIC III	09-	K4M 858/866	1.6	07755100	203
SCENIC III	09-	F9Q 870/872	1.9 DCI	07755700	204
SCENIC III	09-	M9R 610/615	2.0D DCI	07755500	205
TRAFFIC	98-	F8Q 600/606	1.9D	07755700	204
TRAFFIC	89-01	S8U 720/722/750/752/758	2.5D	07751500	205
TRAFFIC II	01-	F9Q 760/762	1.9 DCI	07755200	204
TRAFFIC II	01-	F4R 720/722/820	2.0	07755100	203
TRAFFIC II	06-	M9R 780/782/784/786/788	2.0 DCI	07755500	205
TRAFFIC II	02-	G9U 630/730	2.5 DCI	07755200	204
TWINGO I	93-96	D7F 700/701/702/703/704/706/708	1.2	07755700	204
TWINGO I	01-	D4F 702/704/708	1.2 16V	07755700	204
TWINGO II	07-	D7F 800	1.2	07755700	204
TWINGO II	07-	D4F 772/780/782	1.2 16V	07755700	204
TWINGO II	07-	K9K 718/740/820	1.5D DCI	07755700	204
TWINGO II	08-	K4M 854	1.6	07755100	203
VEL SATIS	05-	M9R 740/760/762/763	2.0 DCI	07755500	205
VEL SATIS	00-	F4RT 762/763/764/765/766/767/867	2.0 16V	07755100	203
VEL SATIS	02-	G9T 600/606/607/700/702/703	2.2 DCI	07755200	204
ROVER / MG					
25	99-01	K8-1.1	1.1	SP23111-12	206
25	99-01	K14	1.4	02240000	206
25	99-01	K16-16	1.6	02240000	206
25	99-01	K16-18	1.6	02240000	206
45	99-01	K14+	1.4	02240000	206
45	99-01	K16-16	1.6	02240000	206
45	99-01	K16-18	1.6	02240000	206
45	99-01	KV6	2.0	07761000	206
75	99-	M47R	DIESEL	07759000	152
75	99-00	K1.8	1.8	02240000	206
75	99-01	KV6	2.0	07761000	206

MODEL	YEAR	ENGINE CODE	ENGINE SIZE	PART NO.	PAGE NO.
ROVER / MG CONTINUED					
75	99-01	KV6	2.5	07761000	206
75	99-00	K1.8	TOURING	02240000	206
75	99-01	KV6	TOURING	07761000	206
100	95-98	K8-1.1	1.1	SP23111-12	206
100	95-98	K8-1.4	1.4	SP23111-12	206
115	95-98	VJY/VYZ TUD3	1.5D	07754400	160
200	98-99	K8-1.1	1.1	SP23111-12	206
200	95-99	18K16	200 VI	02240000	206
214	95-99	14K16	1.4	02240000	206
214	95-99	14K8	1.4	SP23111-12	206
216	95-99	16K16	1.6	02240000	206
218	96-99	18K16	COUPE	02240000	206
414	95-99	K16-1.4	1.6	02240000	206
416	95-99	K16-1.6	1.6	02240000	206
416	96-99	16K16	TOURER	02240000	206
825	96-99	KV6	2.5	07761000	206
MG TF	01-02	K16-1.8	1.8	02240000	206
MGF	99-01	16K16	1.6	02240000	206
MGF	95-01	K16-1.8	1.8	02240000	206
MGF	01-02	K16-1.8	TROPHY 160SE VVC	02240000	206
MGF	95-01	K16-1.8	VVC	02240000	206
MGZR	01-05	K16-14+	1.4	02240000	206
MGZR	01-05	K16-18	1.8	02240000	206
MGZR	01-02	K16-18	1.8	02240000	206
MGZR	04-05	KV6(150)	2.0	07761000	206
MGZS	01-05	K16-16	1.6	02240000	206
MGZS	01-02	K16-18	1.8	02240000	206
MGZS	01-05	KV6	2.5	07761000	206
MGZT	01-02	KV6	2.0	07761000	206
MGZTT	01-02	KV6	2.5	07761000	206
SAAB					
900	93-98	B258I	2.5	07753500	207
9-3	03-	Z18XE	1.8	07764600	191
9-3	04-	Z19DT, Z19DTH	1.9D TID	07764700	207
9-3	07-	Z19DTR	1.9D TTID	07764700	207
9-3	98-	D223L	2.2D TID	07753300	207
9-5	05-	Z19DTH	1.9D TID	07764700	207
9-5	02-	D223L	2.2D TID	07753300	207
9-5	98-03	B308E	3.0	07753500	207
SEAT					
ALHAMBRA	10-	CAVA, CTHA	1.4 TSI	07763400	208
ALHAMBRA	97-	AJH, AWC	1.8 TURBO	07757200	209
ALHAMBRA	96-	1Z, AFN, AHU, AVG,	1.9 TDI	07757900	210
ALHAMBRA	99-	ANU, ASZ, AUY, BTB, BVK	1.9 TDI PD	077562V2	210
ALHAMBRA	96-	ADY, ATM	2.0I	07756005	231
ALHAMBRA	05-	BRT, BVH	2.0D TDI	077562V2	210
ALHAMBRA	10-	CFFA, CFFB, CFGB	2.0D TDI CR	07757100	211
ALTEA	10-	CBZB	1.2 TSI	07763600	208
ALTEA	06-	BXW, CGGB	1.4	07756014	209
ALTEA	08-	CAXC	1.4 TSI	07763400	208
ALTEA	04-	BGU, BSE, BSF, CCSA, CHGA, CMXA	1.6	07756005	231
ALTEA	09-	CAYB, CAYC	1.6D TDI CR	07757100	211
ALTEA	04-	BJB, BKC, BLS, BXE, BXF,	1.9TDI PD	077562V2	210
ALTEA	05-	BLR, BLY, BVY, BVZ, BWA	2.0 16V FSI	07756700	209
ALTEA	04-	AZV, BKD, BMM, BMN	2.0 TDI PD	077562V2	210

MODEL	YEAR	ENGINE CODE	ENGINE SIZE	PART NO.	PAGE NO.
SEAT CONTINUED					
ALTEA	09-	CEGA, CFHC, CFJA	2.0 TDI CR	07757100	211
ALTEA	06-	BWA	2.0 TSI	07756700	209
AROSA	98-05	AFK, AQQ, AUB	1.4 16V	07756014	209
AROSA	99-05	AMF	1.4 TDI PD	077562V2	210
AROSA	99-05	AKU	1.7 SDI	07757900	210
CORDOBA	03-	AZQ, BBM, BME, BXV	1.2 16V	07756100	208
CORDOBA	03-	AUB, BBY, BBZ, BKY, BXW	1.4 16V	07756014	209
CORDOBA	03-	AMF, BMS, BNM, BNV	1.4TDI PD	077562V2	210
CORDOBA	95-	1F, AFT	1.6I	07756005	231
CORDOBA	06-	BTS	1.6 16V	07763400	208
CORDOBA	98-99	AKW	1.7DSDI	07757900	210
CORDOBA	93-	ABS, ADL, ADZ	1.8I	07756005	231
CORDOBA	93-99	1Y, AAZ, AEY	1.9D/DT/SDI	07757900	210
CORDOBA	96-	1Z, AFN, AHU, ALH	1.9 TDI	07757900	210
CORDOBA	03-	ASZ, ATD, AXR, BLT, BMT, BPX, BUK	1.9 TDI PD	077562V2	210
CORDOBA	93-	2E, ABF, ADY, AGG, AZL, BBX	2.0I	07756005	231
EXEO	09-	ALZ	1.6	07756005	231
EXEO	09-	BWE	2.0 TSI	07756700	209
EXEO	09-	CAGA, CAGC, CAHA	2.0D TDI PD	07757100	211
IBIZA	02-	AZQ, BBM, BME, BXV, BZG, CGPA/B	1.2 12V	07756100	208
IBIZA	10-	CBZA, CBZB	1.2 TSI	07763600	208
IBIZA	10-	CFWA	1.2 TDI CR	07757100	211
IBIZA	99-	APE, AQQ, AUA, AUB, BBY, BBZ	1.4 16V	07756014	209
IBIZA	05-	BKY, BXW, CGGB	1.4I CAT	07756014	209
IBIZA	09-	CAVE, CAVF	1.4 TSI	07763400	208
IBIZA	03-	AMF, BMS, BNM, BNV	1.4TDI PD	077562V2	210
IBIZA	94-	1F, AEH, AFT, AKL, APF, AUR	1.6I	07756005	231
IBIZA	06-	BTS	1.6 16V	07763400	208
IBIZA	09-	CAYA, CAYB, CAYC, CLNA	1.6D TDI CR	07757100	211
IBIZA	98-99	AKW	1.7D SDI	07757900	210
IBIZA	93-	ABS, ADL, ADZ	1.8 CAT	07756005	231
IBIZA	99-	APY, AQX, AYP, BBU, BJX, BKV, BLZ	1.8T	07757200	209
IBIZA	93-02	1Y, AAZ, AEY, AGP, AQM	1.9D/DT/SDI	07757900	210
IBIZA	93-	1Z, AFN, AGR, AHU, ALH, ASV	1.9 TDI	07757900	210
IBIZA	02-	ARL, ASZ, ATD, AXR, BLS, BLT, BMT, BPX, BUK, BXJ	1.9 TDI PD	077562V2	210
IBIZA	93-	2E, ABF, ADY, AGG, AZL, BBX	2.0	07756005	231
IBIZA	09-	CFHD	2.0D TDI CR	07757100	211
INCA	00-	AUA	1.4 16V	07756014	209
INCA	95-	1F	1.6	07756005	231
INCA	96-	1Y, AEY, AYQ	1.9D/SDI	07757900	210
LEON	99-	AHW, APE, AXP, BCA, BXW, CGGB	1.4 16V	07756014	209
LEON	07-	CAXC	1.4 TSI	07763400	208
LEON	99-	AEH, AKL, APF, BFQ, BSE, BSF, BGU	1.6	07756005	231
LEON	00-	AUS, AZD, BCB	1.6 16V	07756014	209
LEON	07	CCSA, CHGA, CMXA	1.6	07756005	231
LEON	10-	CAYB, CAYC	1.6D TDI CR	07757100	211
LEON	99-	AGN, AJQ, APG, APP, APT, ARY, AUQ, BAM	1.8	07757200	209
LEON	00-	AGP, AQM, ASV	1.9SDI	07757900	210
LEON	99-	AGR, AHF, ALH	1.9TDI	07757900	210

MODEL	YEAR	ENGINE CODE	ENGINE SIZE	PART NO.	PAGE NO.
SEAT CONTINUED					
LEON	00-	ARL, ASZ, BJB, BKC, BLS, BXE, BXF	1.9 TDI PD	077562V2	210
LEON	06-	BLR, BLY, BVY, BVZ, BWA/1	2.0T/FSI	07756700	209
LEON	06-	BWJ, CDLA, CDLD	2.0 TSI/ FSI	07756700	209
LEON	06-	AZV, BKD, BMM, BMN	2.0 TDI PD	077562V2	210
LEON	09-	CEGA, CFHC, CFJA	2.0 TDI CR	07757100	211
TOLEDO	12-	CBZA, CBZB	1.2 TSI	07763600	212
TOLEDO	12-	CAXA	1.4 TSI	07763400	208
TOLEDO	99-	AHW, APE, AXP, BCA, BXW	1.4 16V	07756014	213
TOLEDO	07-	CAXC	1.4 TSI	07763400	208
TOLEDO	94-	1F, AEH, AFT, AKL, AKS	1.6	07756005	231
TOLEDO	00-	AUS, AZD, BCB	1.6 16V	07756014	213
TOLEDO	05-	BGU, BSE, BSF, CCSA	1.6 MPI	07756005	231
TOLEDO	12-	CAYC, CLNA	1.6 TDI PD	07757100	211
TOLEDO	94-99	ABS, ADZ	1.8	07756005	231
TOLEDO	99-	AGN, APG, APT, AUQ, ARY	1.8/T	07757200	209
TOLEDO	94-99	1Y, AAZ	1.9D/DT	07757900	210
TOLEDO	95-	1Z, AFN, AGR, AHF, AHU, ALH, ASV	1.9 TDI	07757900	210
TOLEDO	00-	ARL, ASZ, BKC, BJB, BLS, BXE	1.9 TDI PD	077562V2	210
TOLEDO	91-98	ZE, ABF, AGG	2.0 CAT	07756005	231
TOLEDO	05-	BLR, BLY, BVY, BVZ, BWA	2.0 FSI	07756700	209
TOLEDO	05-	AZV, BKD, BMM, BMN	2.0 TDI PD	077562V2	210
TOLEDO	09-	CEGA	2.0 TDI CR	07757100	211
SKODA					
FELICIA/ PICK-UP	95-01	AEF	1.9D	07757900	214
FABIA	02-	AWY, AZQ, BMD, BME	1.2	07756100	212
FABIA	99-	AUA/B, BBY/Z, BKY, BUD	1.4 16V	07756014	213
FABIA	03-	AMF, BNM, BNV	1.4D TDI PD	077562V2	214
FABIA	00-	ATD, ASZ, AXR, BLT	1.9D TDI PD	077562V2	214
FABIA	00-	AQY, AZL	2.0	07756005	231
FABIA 2	07-	BBM, BZG, CEVA, CGPA/B	1.2	07756100	212
FABIA 2	10-	CBZA, CBZA	1.2 TSI	07763600	212
FABIA 2	10-	CFWA	1.2D TDI CR	07757100	215
FABIA 2	07-	BXW, CGGB	1.4	07756014	213
FABIA 2	10-	CAVE, CTHE	1.4 TSI/VRS	07763400	212
FABIA 2	07-	BMS, BNM, BNV	1.4 TDI PD	077562V2	214
FABIA 2	07-	BTS, CFNA	1.6	07763400	212
FABIA 2	10-	CAYA, CAYB, CAYC	1.6 TDI CR	07757100	215
FABIA 2	07-	BLS, BSW	1.9 TDI PD	077562V2	214
OCTAVIA	00-	AXP, BCA	1.4 16V	07756014	213
OCTAVIA	97-	AEH, AKL, AVU, BFQ	1.6	07756005	231
OCTAVIA	96-	AGN, AGU, AUM, AUQ, ARX, ARZ	1.8/T	07757200	214
OCTAVIA	97-	AGP, AGR, AHF, ALH, AQM, ASV	1.9 SDI/TDI	07757900	214
OCTAVIA	02-	ASZ, ATD, AXR	1.9 TDI PD	077562V2	214
OCTAVIA	99-	AEG, APK, AQY, AZH, AZJ	2.0	07756005	231
OCTAVIA 2	10-	CBZB	1.2 TSI	07763600	212
OCTAVIA 2	04-	BCA, BUD, CGGA	1.4	07756014	213
OCTAVIA 2	08-	CAXA	1.4 TSI	07763400	212
OCTAVIA 2	04-	BGU, BSE/F, CCSA, CHGA, CMXA	1.6	07756005	231
OCTAVIA 2	04-	BLF	1.6 FSI	07763400	212
OCTAVIA 2	09-	CAYC	1.6D TDI CR	07757100	215
OCTAVIA 2	04-	BJB, BKC, BLS, BXE	1.9 TDI PD	077562V2	214

MODEL	YEAR	ENGINE CODE	ENGINE SIZE	PART NO.	PAGE NO.
SKODA CONTINUED					
OCTAVIA 2	04-	BLR, BLX, BLY, BVX, BVY, BWA	2.0 FSI	07756700	213
OCTAVIA 2	04-	AZV, BKD, BMN, BMM	2.0 TDI PD	077562V2	214
OCTAVIA 2	08-	CEGA, CFHC, CLCA, CLCB	2.0D TDI CR VRS	07757100	215
RAPID	12-	CBZA, CBZB	1.2 TSI	07763600	212
RAPID	12-	CAXA	1.4 TSI	07763400	212
RAPID	12-	CAYC	1.6 TDI CR	07757100	215
ROOMSTER	06-	BME, BZG, CGPA	1.2 12V	07756100	212
ROOMSTER	10-	CBZA, CBZB	1.2 TSI	07763600	212
ROOMSTER	10-	CFWA	1.2 TDI CR	07757100	215
ROOMSTER	06-	BUD, BXW, CGGB	1.4	07756014	213
ROOMSTER	06-	BNM, BNV, BMS	1.4D TDI PD	077562V2	214
ROOMSTER	06-	BTS, CFNA	1.6	07763400	212
ROOMSTER	10-	CAYB, CAYC	1.6 TDI CR	07757100	215
ROOMSTER	06-	AXR, BLS, BSW	1.9 TDI PD	077562V2	214
SUPERB	02-	AWT, AZM	1.8T/2.0	07757200	214
SUPERB	02-	AVB, AVF, AWX, BPZ, BSV	1.9 TDI PD	077562V2	214
SUPERB	05-	BSS	2.0 TDI DPF	077562V2	214
SUPERB	02-	AYM, BDG	2.5 V6 TDI	07757800	215
SUPERB	02-	AMX, BBG	2.8 V6	07757400	213
SUPERB II	08-	CAXC	1.4 TSI	07763400	212
SUPERB II	08-	BLS, BXE	1.9D TDI PD	077562V2	214
SUPERB II	08-	BKD, BMP	2.0 TDI PD	077562V2	214
SUPERB II	08-	CBBB	2.0D TDI CR	07757100	215
YETI	09-	CBZB	1.2 TSI	07763600	212
YETI	10-	CAXA	1.4 TSI	07763400	212
YETI	10-	CAYC	1.6D TDI CR	07757100	215
YETI	09-	CBDB, CEGA, CFHA/C/F, CFJA, CLCB	2.0D TDI CR	07757100	215
SUZUKI					
GRAND VITARA	00-	RHW, RHZ	2.0D	07764000	161
IGNIS	03-	Z13DT	1.3D DDIS	07761900	216
JIMMY	03-	K9K 262/266/299	1.5D DDIS	07755700	216
SPLASH	08-	D13A, Z13DTJ	1.3D DDIS	07761900	216
SWIFT	04-	D13A,Z13DT	1.3D DDIS	07761900	216
WAGON	05-08	Z10XEP, Z12XEP	1.0/1.2	07753200	216
WAGON R	03-	Z13DT	1.3D DDIS	07761900	216
TOYOTA					
AURIS	06-	IND-TV	1.4-4D	07764800	217
AURIS	06-	1ZR-FE	1.6	07764800	217
AURIS	06-	2AD-FHV	2.2D-4D	07764800	217
AVENSIS	99-	1CD-FTV	2.0D-4D	07764800	217
AVENSIS	05-	2AD-FTV, 2AD-FHV	2.2D-4D	07764800	217
AYGO	05-	1KR-FE	1.0	07764800	217
AYGO	05-	2WZ-TV	1.4D D-4D	07764800	217
COROLLA	04-	1ND-TV	1.4D D-4D	07764800	217
COROLLA	01-03	1CD-FTV	2.0D	07764800	217
COROLLA	07-	1ZR-FE	1.6i	07764800	217
COROLLA VERSO	01-05	1CD-FTV	2.0D	07764800	217
COROLLA VERSO	05-09	2AD-FTV	2.2D	07764800	217
IQ	08-	1KR-FE	1.0 VVT-I	07764800	217
IQ	08-	1ND-TV	1.4D D-4D	07764800	217
PREVIA	00-	1CD-FTV	2.0D	07764800	217
PRIUS MK1	00-03	1NZ-FXE	1.5	07764800	217
PRIUS MK2	03-09	1NZ-FXE	1.5	07764800	217
RAV4	01-06	1CD-FTV	2.0D	07764800	217
RAV4	06-	2AD-FTV, 2AD-FHV	2.2 16V	07764800	217
URBAN CRUISER	08-	1ND-TV	1.4D D-4D	07764800	217

MODEL	YEAR	ENGINE CODE	ENGINE SIZE	PART NO.	PAGE NO.
TOYOTA CONTINUED					
VERSO	09-	2AD-FTV, 2AD-FHV	2.2D D-CAT	07764800	217
YARIS	99-	1KR-FE, 1SZ-FE	1.0	07764800	217
YARIS	02-	2SZ-FE	1.3	07764800	217
YARIS/VERSO	01-	1ND-TV	1.4D D-4D	07764800	217
VOLKSWAGEN					
AMAROK	10-	CDBA, CDCA	2.0D TDI CR	07757100	221
BEETLE	01-	BCA	1.4I 16V	07756014	219
BEETLE	00-	AYD, BFS	1.6	07756005	231
BEETLE	99-	AVC, AWU	1.8T	07757200	219
BEETLE	98-	AGR, ALH	1.9 TDI	07757900	220
BEETLE	01-	ATD, AXR, BSW	1.9 TDI PD	077562V2	221
BEETLE	98-	APK, AQY, AZJ	2.0I	07756005	231
NEW BEETLE	11-	CBZB	1.2 TSI	07763600	218
NEW BEETLE	11-	CCZA	2.0 TSI	07757300	219
BORA	97-	AHW, AKQ, APE, AXP, BCA	1.4I 16V	07756014	219
BORA	98-	AEH, AKL, AKS, APF, AVU, BFQ	1.6I	07756005	231
BORA	00-	ATN, AUS, AZD, BAD, BCB	1.6I/FSI	07756014	219
BORA	98-	AGN, AGU, AQA, ARZ, AUM, AUQ	1.8/T	07757200	219
BORA	98-	AGP, AQM	1.9 SDI	07757900	220
BORA	98-	AGR, AHF, ALH, ASV	1.9 TDI	07757900	220
BORA	99-	AJM, ANU, ARL, ASZ, AUY, AXR	1.9 TDI PD	077562V2	221
BORA	99-	APK, AQY, ATU, AZG, AZH, AZJ, BEH	2.0I	07756005	231
CADDY	99-	APE, AUA	1.4 16V	07756014	219
CADDY	95-	1F, AFT	1.6	07756005	231
CADDY	96-00	AHB, AKW	1.7 SDI	07757900	220
CADDY	96-04	1Y, AEY, AQM, AYQ	1.9D/SDI	07757900	220
CADDY	97-03	AFN, AHU, ALE, ALH, ASV	1.9 TDI	07757900	220
CADDY MAXI	10-	CBZA, CBZB	1.2 TSI	07763600	218
CADDY MAXI	04-	BCA, BUD	1.4	07756014	219
CADDY MAXI	04-	BGU, BSE, BSF	1.6	07756005	231
CADDY MAXI	10-	CAYD, CAYE	1.6D TDI CR	07757100	221
CADDY MAXI	04-	BJB, BLS, BSU	1.9 TDI PD	077562V2	221
CADDY	06-	BSX	2.0 CNG	07756005	231
CADDY MAXI	04-	BDJ, BST, BMM	2.0 SDI/TDI PD	077562V2	221
CADDY MAXI	10-	CFHC, CFHE, CFHF, CLCA, CKTB, CKTC, CKUB, CKUC	2.0D TDI CR	07757100	221
CRAFTER	06-	BJJ, BJK, BJM, CEBA, CEBB, CECA, CECB	2.5 TDI	077564V2	222
EOS	07-	CAVA, CAVB, CAVC, CAVD, CAXA	1.4 TSI	07763400	218
EOS	06-07	BLF	1.6 FSI	07763400	218
EOS	06-	BVY, BVZ	2.0 FSI	07756700	220
EOS	06-	BPY, BWA	2.0 TFSI	07756700	220
EOS	06-	BMM	2.0 TDI PD	077562V2	221
EOS	08-	CBAB, CFFA, CFFB	2.0D TDI CR	07757100	221
FOX	05-	BMD, CHFA, CHFB.	1.2	07756100	218
FOX	05-	BNM	1.4 TDI PD	077562V2	221
GOLF III	94-	AEK, AKS, AFT	1.6	07756005	231
GOLF III	94-98	AAZ, AEY	1.9 DT/SDI	07757900	220
GOLF III	93-98	1Z, AFN, AHU, ALE	1.9 TDI	07757900	220
GOLF III	92-98	ABF	2.0 16V CAT	07756005	231
GOLF IV	97-	AHW, AKQ, APE, AXP, BCA, BUD	1.4 16V	07756014	219
GOLF IV	06-08	BLG	1.4 FSI	07763400	218
GOLF IV	06-	BMY, CAVD, CAXA	1.4 TSI	07763400	218
GOLF IV	99-	ATN, AUS, AZD	1.6	07756014	219

MODEL	YEAR	ENGINE CODE	ENGINE SIZE	PART NO.	PAGE NO.
VOLKSWAGEN CONTINUED					
GOLF IV	97-	AEH, AKL, AKS, APF, AVU, BFQ, BSE, BSF, BGU, CCSA	1.6	07756005	231
GOLF IV	02-06	BAD, BCB	1.6 16V FSI	07756014	219
GOLF IV	97-	AGN, AGU, AQA, ARZ, AUM, AUQ	1.8/T	07757200	219
GOLF IV	97-	AGP, AGR, AHF, ALH, AQM, ASV, AVG	1.9 SDI/TDI	07757900	220
GOLF IV	99-	AJM, ANU, ARL, ASZ, ATD, AUY, AXR	1.9 TDI PD	077562V2	221
GOLF IV	99-	APK, AQY, ATU, AWF, AWG, AZG, AZH, AZJ, BEH	2.0	07756005	231
GOLF V	03-	BKG, BLN	1.4 FSI	07763400	218
GOLF V	03-	BAG, BLF, BLP	1.6 FSI	07763400	218
GOLF V	03-	BJB, BKC, BLS, BRU, BXE, BXF, BXJ	1.9 TDI PD	077562V2	221
GOLF V	04-	AXW, AXX, BLR, BLY, BLX, BPY, BVX, BVY, BVZ, BWA, BYD	2.0 FSI	07756700	220
GOLF V	03-	AZV, BKD, BMN, BMM	2.0 SDI	077562V2	221
GOLF VI	10-	CBZA, CBZB	1.2 TSI	07763600	218
GOLF VI	08-	CGGA	1.4	07756014	219
GOLF VI	08-	CAVB, CAVC	1.4 TSI	07763400	218
GOLF VI	09-	CHGA, CMXA	1.6	07756005	231
GOLF VI	09-	CAYB, CAYC	1.6D TDI CR	07757100	221
GOLF VI	09-	CDAA	1.8 TSI	07757300	219
GOLF VI	09-	CCZA	2.0 TSI	07757300	219
GOLF VI	10-	CDLA, CDLC, CDLF	2.0R	07756700	220
GOLF VI	08-	CBAA/B, CBBB, CBDC, CFFA/B, CFGB, CJAA, CLCA	2.0D TDI CR	07757100	221
GOLF PLUS	10-	CBZA, CBZA	1.2 TSI	07763600	218
GOLF PLUS	09-	CGGA	1.4	07756014	219
GOLF PLUS	09-	CAVD, CAXA	1.4 TSI	07763400	218
GOLF PLUS	09-	BSE/F, CCSA, CHGA, CMXA	1.6	07756005	231
GOLF PLUS	09-	CAYB, CAYC	1.6D TDI CR	07757100	221
GOLF PLUS	09-	CBDA/B/C, CFHB/C, CLCA	2.0D TDI CR	07757100	221
JETTA	11-	CBZB	1.2 TSI	07763600	218
JETTA	06-	BLG, BMY, CAXA, CAVD	1.4 TSI	07763400	218
JETTA	05-	BSE, BSF, CCSA, CMXA	1.6	07756005	231
JETTA	05-	BLF	1.6 16V FSI	07763400	218
JETTA	09-	CAYB, CAYC	1.6D TDI CR	07757100	221
JETTA	05-	BKC, BLS, BRM, BXE	1.9 TDI PD	077562V2	221
JETTA	05-	BLR, BLY, BVY, BVZ	2.0 16V	07756700	220
JETTA	08-	CBDA, CBDB, CEGA	2.0 TDI CR	07757100	221
JETTA	05-	AZV, BKD, BMN, BMM	2.0 TDI PD	077562V2	221
JETTA	05-	AXX, BPY, BWA	2.0 TFSI	07756700	220
JETTA	08-	CAWB, CCTA	2.0 TSI	07757300	219
LUPO	99-	ANY, AYZ	1.2 TDI PD	077562V2	221
LUPO	98-	AFK, AKQ, AHW, APE, AQQ, AUA, AUB, BBY, ARR	1.4I 16V	07756014	219
LUPO	99-	AMF	1.4 TDI	077562V2	221
LUPO	99-	ARC, AVY	1.6 GTI	07756014	219
LUPO	98-	AKU	1.7 SDI	07757900	220
PASSAT	09-	CAXA, CDGA, CKMA	1.4 TSI	07763400	218
PASSAT	97-	ADP, AFT, AHL, AKS, ANA, ARM, ALZ, BSE, BSF	1.6	07756005	231
PASSAT	05-	BLF, BLP	1.6 FSI	07763400	218
PASSAT	09-	CAYC	1.6D TDI CR	07757100	221
PASSAT	97-	ADR, AEB, ANB, APT, APU, ARG, AWT	1.8I/T	07757200	219

MODEL	YEAR	ENGINE CODE	ENGINE SIZE	PART NO.	PAGE NO.
VOLKSWAGEN CONTINUED					
PASSAT	07-	BZB, CDA, CDAB, CGYA	1.8 TSI	07757300	219
PASSAT	97-	AFN, AHH, AHU, AVG	1.9 TDI	07757900	220
PASSAT	99-	AJM, ATJ, AVB, AVF, AWW, BKC, BLS, BXE	1.9 TDI PD	077562V2	221
PASSAT	01-	AZM	2.0	07756005	231
PASSAT	02-05	ALT	2.0 20V	07757200	219
PASSAT	05-	BLR, BLX, BLY, BVX, BVY, BVZ	2.0 FSI	07756700	220
PASSAT	07-	CAWB, CBFA, CCTA, CCZA/B	2.0 TSI	07757300	219
PASSAT	05-	AXX, BPY, BWA,	2.0 TFSI	07756700	220
PASSAT	03-	BGW, BHW, BKP, BMA/P/R, BUZ, BVE, BWV	2.0 DTI PD	077562V2	221
PASSAT	08-	CBAA/B/C, CBBB, CBDC, CFFA/B, CFGB, CLLA	2.0 DTI CR	07757100	221
PASSAT	98-	AFB, AKN, BAU, BDG, BDH	2.5 TDI	07757800	223
PASSAT	00-	AGE, ALG, AMX, AQD, APR, ATX, BBG	2.8	07757400	220
PASSAT CC	08-	CAWB, CCZA	2.0 TSI	07757300	219
PASSAT CC	08-	CBAA/B/C, CBBB, CFFA/B, CFGB	2.0 TDI CR	07757100	221
PHAETON	04-	BMK, CARA, CEXA	3.0 TDI	07757700	222
POLO III	99-	AFFK, AHW, APE, AUA, AUB, AQQ	1.4 16V	07756014	219
POLO III	99-02	AMF	1.4 TDI PD	077562V2	221
POLO III	00-02	AEH	1.6	07756005	231
POLO III	98-02	AJV, ARC, AVY	1.6 16V	07756014	219
POLO III	96-00	AHG, AKU	1.7 D/SDI	07757900	220
POLO III	95-02	1Y, AEF, AEY, AGD, AQM, ASX	1.9 D/SDI	07757900	220
POLO III	97-	AFN, AHU, ALE, ASV	1.9 TDI	07757900	220
POLO IV	02-	AWY, AZQ, BBM, BMD, BME, BZG	1.2	07756100	218
POLO IV	02-	AUA, AUB, BBY, BBZ, BKY, BUD	1.4 16V	07756014	219
POLO IV	02-	AXU	1.4 16V FSI	07763400	218
POLO IV	02-	AMF, BAY, BNM, BNV, BMS, BWB	1.4 TDI PD	077562V2	221
POLO IV	06-	BTS	1.6 16V	07763400	218
POLO IV	05-	BBU, BJX	1.8 GTI	07757200	219
POLO IV	02-	ASZ, ATD, AXR, BLT, BMT	1.9 TDI PD	077562V2	221
POLO V	09-	CGPA/B, CHFA	1.2	07756100	218
POLO V	10-	CFWA	1.2 TDI CR	07757100	221
POLO V	09-	CBZA, CBZB, CBZC	1.2 TSI	07763600	218
POLO V	09-	CGGB, CMAA	1.4	07756014	219
POLO V	10-	CAVB, CAVE, CTHE	1.4 GTI	07763400	218
POLO V	09-	CAYA, CAYB, CAYC, CLNA	1.6D TDI CR	07757100	221
SCIROCCO	08-	CAVD, CAXA	1.4 TSI	07763400	218
SCIROCCO	09-	CDLA, CDLC	2.0R	07756700	220
SCIROCCO	08-	CBBB, CBDB, CFHB/C, CFGB	2.0D TDI CR	07757100	221
SHARAN	10-	CAVA, CTHA	1.4 TSI	07763400	218
SHARAN	97-06	AJH, AWC	1.8T	07757200	219
SHARAN	95-99	1Z, AFN, AHU, AVG	1.9 TDI	07757900	220
SHARAN	99-	ANU, ASZ, AUY, BTB, BVK	1.9 TDI PD	077562V2	221
SHARAN	95-	ADY, AKT	2.0	07756005	231
SHARAN	00-	ATM	2.0	07756005	231
SHARAN	05-	BRT, BVH	2.0 TDI PD	077562V2	221
SHARAN	10-	CFFA, CFFB, CFFE, CFGB	2.0 TDI PD CR	07757100	221

MODEL	YEAR	ENGINE CODE	ENGINE SIZE	PART NO.	PAGE NO.
VOLKSWAGEN CONTINUED					
TIGUAN	07-	BWK, CAVA/D, CTHD	1.4 FSI	07763400	218
TIGUAN	07-	CAW/B, CCZA/B/C/D, CCTA	2.0 TSI	07757300	219
TIGUAN	07-	CBAA/B, CBBA/B, CF-FA/B/D, CFGB, CLJA	2.0 TDI CR	07757100	221
TOUAREG	03-	BAC, BLK, BPD, BPE	2.5 TDI PD	07757600	223
TOUAREG	03-	BKS, BUN, CASA/B/C/D, CATA	3.0 V6 TDI	07757700	222
TOUAREG	10-	CKDA	4.2 TDI PD	07757700	222
TOURAN	10-	CBZB	1.2 TSI	07763600	218
TOURAN	06-	BKG, BLG, BLN, BMY,	1.4 FSI	07763400	218
TOURAN	06-	CAVB, CAVC, CDGA	1.4 TSI	07763400	218
TOURAN	03-	BGU, BSE, BSF	1.6	07756005	231
TOURAN	03-07	BAG, BLF, BLP	1.6 FSI	07763400	218
TOURAN	10-	CAYB, CAYC	1.6D TDI CR	07757100	221
TOURAN	03-	AVQ, BKC, BRU, BTB, BXE, BXF, BLS, BXJ	1.9 TDI PD	077562V2	221
TOURAN	06-10	BSX	2.0	07756005	231
TOURAN	03-09	AXW, BLR, BLX, BLY, BVY, BVZ	2.0 FSI	07756700	220
TOURAN	10-	CFHC, CFJA, CLCA	2.0 TDI CR	07757100	221
TOURAN	03-	AZV, BKD, BMM, BMN	2.0 TDI PD/ (DPF)	077562V2	221
TRANSPORTER T4	90-03	PD, AAC	1.8/2.0	07756005	231
TRANSPORTER T4	90-	AAB, AJA	2.4D	077564V2	222
TRANSPORTER T4	95-	ACV, AHY, AJT, AUF, AXG, AXL, AYC/Y,	2.5D TDI	077564V2	222
TRANSPORTER / MULTIVAN T5	03-	AXB, AXC, BRR, BRS	1.9 TDI PD	077562V2	221
TRANSPORTER / MULTIVAN T5	03-	AXA	2.0	07756005	231
TRANSPORTER / MULTIVAN T5	09-	CAAA, CAAB, CAAC, CFCA, CCHA	2.0D TDI CR	07757100	221
TRANSPORTER / MULTIVAN T5	03-	AXD, AXE, BLJ, BNZ, BPC	2.5D TDI	07757600	223
VENTO	94-98	AEK, AFT, AKS	1.6	07756005	231
VENTO	94-	1Y, AAZ, AEF, AEY	1.9D/TD	07757900	220
VENTO	93-98	1Z, AFN, AHU, ALE	1.9 TDI	07757900	220
VENTO	92-97	ABF	2.0 16V CAT	07756005	231
VOLVO					
C30	06-	D4162T, D4164T	1.6D	07763900	225
C30	06-	B4164S3/S8/S11	1.6/1.8/F	077523V2	224
C30	06-10	D4204T/T2	2.0D	07752800	225
C30	06-	B4204S3	2.0	077523V2	224
C30	10-	D5204T/T5	2.0D D3/D4	07764100	224
C30	09-	B4204S4	2.0 F	077523V2	224
C30	06-	D5244T9	2.4D	07764100	224
C30	06-	B5244S4/S5/S7	2.4	07764100	224
C30	06-	D5244T8/T13	2.4 D5	07764100	224
C30	05-	B5254T3/T7	2.5T/T5	07764100	224
C70	97-	B5204T2/T3/T4	2.0T	07755600	224
C70	07-	D4204T/T5	2.0D	07752800	225
C70	97-	B5234T3/T6/T9	2.3T	07755600	224
C70	97-	B5244S/S4/S5	2.4	07755600	224
C70	00-	B5244T/T7	2.4T	07755600	224
C70	06-	D5244T8/T9/T13	2.4D D5	07764100	224
C70	97-	B5254FS	2.5	07764100	224
C70	97-	B5254T/T3/T7	2.5T	07755600	224
S40	97-	B4164S/S2	1.6	07755600	224
S40	04-	B4164S3	1.6	077523V2	224
S40	96-	B4184S/S2/S3/S9/S10	1.8	07755600	224
S40	98-	B4194T/T2	1.9 TURBO	07755600	224
S40	96-99	B4204S/S2	2.0 16V	07755600	224

MODEL	YEAR	ENGINE CODE	ENGINE SIZE	PART NO.	PAGE NO.
VOLVO CONTINUED					
S40	98-	B4204T/T2/T3/T5	2.0 TURBO	07755600	224
S40	04-	D4162T, D4164T/DRIVE	1.6D/D2	07763900	225
S40	04-	B4184S8/S11	1.8/F	077523V2	224
S40	06-	B4204S3/S4	2.0/F	077523V2	224
S40	04-	D4204T/T2	2.0D	07752800	225
S40	10-	D5204T/T5	2.0D D3/D4	07764100	224
S40	03-	B5244S/S4/S5/S7	2.4	07764100	224
S40	06-10	D5244T8/T9/13	2.4D	07764100	224
S40	04-	B5254T3/T7	2.5 (T5)	07764100	224
S60	11-	D4162T	1.6D	07763900	225
S60	00-09	B5204T5	2.0T	07755600	224
S60	10-	D5204T2/T3	2.0D	07764100	224
S60	00-04	B5234T3/T7	2.3T	07755600	224
S60	00-	B5244S/S2/SG/SG2	2.4	07755600	224
S60	00-03	B5244T3/T4/T5	2.4T	07755600	224
S60	01-07	D5244T/T2/T3/T4/T5/T7/T10/T11/T15	2.4D D5	07764100	224
S60	02-	B5254T2, B5254T4/T5	2.5R/T	07755600	224
S70	97-	B5202FS	2.0	07755600	224
S70	97-00	B5204T2/T3/T4	2.0 TURBO	07755600	224
S70	97-	B5234FS	2.3	07755600	224
S70	97-	B5234T3/T4/T6/T7	2.3 TURBO	07755600	224
S70	96-00	B5244S/S2/SG/SG2	2.3 TURBO	07755600	224
S70	99-00	B5244T	2.4T	07755600	224
S70	97-	B5252FS	2.5 10V	07755600	224
S70	97-	B5254FS	2.5 20V	07764100	224
S70	97-00	B5254T	2.5 TURBO	07755600	224
S80	09-	D4162T, D4164T	1.6D	07763900	225
S80	98-	B5204T3/T4/T5	2.0T	07755600	224
S80	07-	B4204S3/S4	2.0/F	077523V2	224
S80	07-	D4204T	2.0D	07752800	225
S80	10-	D5204T2/T3	2.0D	07764100	224
S80	99-	B5234T7	2.3T	07755600	224
S80	98-	B5244S/S2/SG/SG2	2.4	07755600	224
S80	00-	B5244T3/T4	2.4T	07755600	224
S80	00-	D5244T/2/4/T5/T10/T11/14/15/19	2.4D D5	07764100	224
S80	98-	B5254T2/T6/T8/T10/T11	2.5T/FT	07764100	224
S80	98-01	B6284T	2.8 T6	07764100	224
S80	99-	B6294S/S2	2.9	07764100	224
S80	98-99	B6304S3	2.9	07764100	224
S80	98-	B6284T2, B6294T	2.9 T6	07764100	224
V40	97-	B4164S/S2	1.6	07755600	224
V40	96-04	B4184S/S2/S3/S9/S10	1.8	07755600	224
V40	98-	B4194T/T2	1.9 TURBO	07755600	224
V40	96-	B4204S/S2	2.0 16V	07755600	224
V40	98-	B4204T/T2/T3/T5	2.0 TURBO	07755600	224
V50	04-	D4162T, D4162T/DRIVE	1.6D	07763900	225
V50	04-07	B4164S3	1.6	077523V2	224
V50	04-	B4184S8/11	1.8/F	077523V2	224
V50	04-	D4204T/2	2.0D	07752800	225
V50	06-	B4204S3/S4	2.0/F	077523V2	224
V50	10-	D5204T/5	2.0D D4	07764100	224
V50	07-	D5244T9	2.4D D5	07764100	224
V50	04-	B5244S4/S5/S7	2.4	07764100	224
V50	06-	D5244T8/13	2.4D D5	07764100	224
V50	04-	B5254T3/T7	2.5 (T5)	07764100	224
V60	11-	D4162T	1.6D 16V	07763900	225
V60	10-	D5204T2/3	2.0D/D3	07764100	224
V60	10-	D5244T10/11/15	2.4D D5	07764100	224

MODEL	YEAR	ENGINE CODE	ENGINE SIZE	PART NO.	PAGE NO.
VOLVO CONTINUED					
V70	09-	D4162T, D4164T	1.6D	07763900	225
V70	97-00	B5202FS	2.0	07755600	224
V70	97-	B5204T2	2.0 TURBO	07755600	224
V70	97-	B5204T3/4/5	2.0 TURBO	07755600	224
V70	07-	B4204S3/4	2.0	077523V2	224
V70	07-	D4204T	2.0D	07752800	225
V70	10-	D5204T2/3	2.0D	07764100	224
V70	97-98	B5234FS	2.3	07755600	224
V70	96-	B5234T3/7/8	2.3 TURBO	07755600	224
V70	97-	B5234T4/6	2.3 TURBO	07755600	224
V70	97-	B5244S/SG/2	2.4	07755600	224
V70	96-	B5244T/3/4/5	2.4T	07755600	224
V70	99-00	B5244T2	2.4T	07764100	224
V70	01-	D5244T2/3/4/5/6/7/10/11/12/14/15/19	2.4D D5	07764100	224
V70	97-	B5252FS	2.5 10V	07755600	224
V70	97-99	B5254FS	2.5 20V	07764100	224
V70	96-	B5254T/2/6/10	2.5T	07755600	224
V70	02-	B5254T4	2.5R	07755600	224
V70	08-	B5254T8/11	2.5FT	07764100	224
XC60	10-	D5204T2/3	2.0D	07764100	224
XC60	08-	D5244T/4/5/10/11/14/15/16/17	2.4D D5	07764100	224
XC70	10-	D5204T2/3	2.0D	07764100	224
XC70	02-	B5234T7	2.3T	07755600	224
XC70	04-	B5244T4	2.4T	07755600	224
XC70	02-	D5244T/4/5/10/11/14/15/16/17	2.4D D5	07764100	224
XC70	02-07	B5254T2	2.5 TURBO	07755600	224
XC90	02-	D5244T/4/5/18	2.4D D5	07764100	224
XC90	02-	B5254T2	2.5T	07755600	224
XC90	02-06	B6294T	2.9 T6	07764100	224



OEM REF.	PART NO.	SUPPLIED IN KITS:	PAGE NO.
ALFA ROMEO			
1.822.146.000	07752400	07752400	227
1.822.149.000	SP23169-01	SP23169-01	227
1.822.154.000	SP23169-01	SP23169-01	227
1.825.013.000	SP23107-B	SP23107-B	227
1.825.040.000	SP23110-A	SP23110-A	139
1.825.041.000	SP23110-B	SP23110-B	139
1.825.042.000	SP23110-C	SP23110-C	139
1.842.128.000	07752400	07752400	227
1.860.831.000	07752400	07752400	227
1.860.895.000	SP23107-B	SP23107-B	227
1.860.898.000	SP23111-06Z	07751700	140
1.860.905.000	SP23111-08	07751700	140
1.860.905.010	SP23111-08	07751700	140
1.860.950.000	SP23109	SP23109	227
1.860.965.000	SP23069-07X	07751700	140
1.860.985.000	SP23171-02	07751800 07761900 07763300	140 140 138
1.860.987.000	SP23171-07	07763200 07763300	138 138
1.860.992.000	SP23171-01	07763300	138
1.870.734.000	SP23110-M	SP23110-M	139
1.870.797.000	SP23110-K	SP23110-K	139
1.870.859.000	SP23110-N	SP23110-N	139
1.870.896.900	SP23174-04X	07751700	140
1.870.900.300	SP23221	07751800	140
1.870.900.400	SP23222	07751800	140
1.871.000.200	SP23223	07751800	140
1.871.000.900	SP23171-02	07751800 07761900 07763300	140 140 138
1.895.443.000	SP23107-B	SP23107-B	227
2.000.003.000	SP23111-08	07751700	140
2.000.004.500	SP23231	07763200 07763300	138 138
2.000.012.000	SPE10290	07753900	138
2.000.012.100	SP23056-06	07753900	138
2.000.012.800	SPE10230	07753900	138
2.000.015.800	SP10229-01	07763300	138
2.000.034.400	SP10441	07763200	138
2.190.754.200	SP23111-08	07763200	138
AUDI			
SEE VOLKSWAGEN GROUP			
BMW			
11 0 300	SP61500-01	07761500	151
11 2 300	SP23048-01	07758000 07758200 07759000 07761100 07761200 07767000	148 150 152 148 148 152
11 3 190	SP23048-03	07758000 07761100	148 148
11 3 240	SP23048-02	07758000 07761200	148 148
11 3 320	SP23048-04	07758000 07767000	148 152
11 3 340	SP23048-07	07758000 07761500	148 151
11 3 340	SP23048-12	07759000 07761400 07767000	152 150 152
11 3 340	077567-04/05	07758700	149
11 3 340	SP23048-11Z	07758900	153

OEM REF.	PART NO.	SUPPLIED IN KITS:	PAGE NO.
BMW CONTINUED			
11 3 360	SPE10369	07767000	152
11 3 390	SP23048-05	07758000	148
11 3 450	077588-03	07758800	149
11 4 220	SP23048-05	07758000	148
11 4 281	SP61500-02	07761500	151
11 4 282	SP61500-02	07761500	151
11 4 283	SP61500-02	07761500	151
11 4 290	SP61500-04	07761500	151
11 4 360	07763800	07763800	228
11 5 120	SP23048-13	07761400	150
11 5 120	SP23048-25	07767000	152
11 5 140	07763800	07763800	228
11 5 180	SP23048-36	07759000	152
11 5 320	SP23048-37	07758900	153
11 5 490	SP23048-06	07758000	148
11 6 080	SP23048-37S	07759000	152
11 6 150	077588-01	07758800	149
11 6 180	077588-02	07758800	149
11 6 320	SP23048-09	07759000	152
11 6 322	SP23048-11	07759000	152
11 6 480	SP23048-45	07758900	153
11 7 250/251	077587-02	07758700	149
11 7 250/252	077587-03	07758700	149
11 7 253	077587-06	07758700	149
11 7 260	077587-01	07758700	149
11 8 520	SP61500-05	07761500	151
11 8 690	SPE10411	07761400	150
11 8 691	SPE10411	07761400	150
11 8 692	SPE10411	07761400	150
11 8 693	SPE10411	07761400	150
11 8 700	SPE10413	07761400	150
11 8 710	SPE10412	07761400	150
11 8 711	SPE10412	07761400	150
11 8 712	SPE10412	07761400	150
11 8 740	SP23048-46	07758900	153
11 8 760	SP23048-35Z	07758900	153
11 9 190	077587-07	07758200 07758700 07759200	150 149 151
11 9 280	07763800	07763800	228
11 9 290	SP23048-17	07758200	150
11 9 291	SP23048-17	07758200	150
11 9 292	SP23048-15	07758200	150
11 9 293	SP23048-18	07758200	150
11 9 330	07763800	07763800	228
11 9 340	077587-04/05	07758700	149
11 9 340	SP23048-14	07758200 07758700 07761400	150 149 150
11 9 341	SP23048-14	07758200 07758700 07761400	150 149 150
11 9 342	SP23048-14	07758200 07758700 07761400	150 149 150
11 9 350	SP23048-16	07758200	150
11 9 461	SP23673-01	07759200	151
11 9 462	SP23673-03	07759200	151
11 9 463	SP23673-04	07759200	151

OEM REF.	PART NO.	SUPPLIED IN KITS:	PAGE NO.
CHEVROLET			
EN-6333	SP23056-05	07753900	154
EN-6340	SP23056-06	07753900	154
EN-6349	SP23174-01	07753900	154
EN-6625	SPE10230	07753900	154
EN-48245	SP23036-02	07753800	154
EN-48246	SP23036-01	07753800	154
EN-49977-100	SPE10562	07763500	154
EN-49977-200	SPE10329	07763500	154
EN-49978	SPE10656	07763500	154
KM-911	SP23164-04	07753900	154
KM-955-1	SP23164-15Z	07763500	154
KM-955-2	SP23164-16Y	07763500	154
KM-952	SP23164-11	07763500	154
KM-953-A	SP23164-11EX	07763500	154
KM-6628A	SPE10290	07753900	154
CHRYSLER / JEEP			
8929	SP23241-03	07760000	155
8932	SP23241-01	07760000	155
8933	SP23241-02	07760000	155
VM1052	SP62001-04	07762000	155
VM1053	SP62001-05	07762000	155
VM1068	SP62001-03	07762000	155
VM1080	SP62001-02	07762000	155
VM8873	SP62001-01	07762000	155
VM9660	SP62001-06	07762000	155
CITROËN			
SEE PSA			
DACIA			
MOT 1054	SP23069-23	07755100	163
MOT 1430	SP23069-25	07755700	163
MOT 1489	SP23054-04	07755100	163
MOT 1496	SP23069-52	07755100	163
FIAT & IVECO			
1.860.617.000	SP23069-04	07751600 07764500	169 169
1.860.638.000	SP23101	07751500	169
1.860.697.000	SP23110-P	07761800	166
1.860.771.000	SP23111-04	07751800	166
1.860.815.000	SP310125008	07764500	169
1.860.831.000	07752400	07752400	227
1.860.845.000	SP23169-02	07751C00 07761800	166 166
1.860.846.000	SP313106000	07764500	169
1.860.847.000	SP23110-D	07751C00	166
1.860.874.000	SP23112	07751800	166
1.860.875.000	SP23110-E	07751C00	166
1.860.876.000	SP23113	07751800	166
1.860.892.000	SP23110-F	SP23110-F	167
1.860.898.000	SP23111-06	07751C00 07761800	166 166
1.860.898.000	SP23111-06Z	07751700	168
1.860.899.000	SP23110-G	07751A00	165
1.860.901.000	SP23111-07	07751A00	165
1.860.905.000	SP23111-08	07751700 07761800	168 166
1.860.905.010	SP23111-08	07761800	166
1.860.962.000	SP23110-J	SP23110-J	167
1.860.965.000	SP23069-07X	07751700	168
1.860.985.000	SP23171-02	07763300	165
1.860.987.000	SP23171-07	07751900 07763200 07763300	164 165 165



OEM REF.	PART NO.	SUPPLIED IN KITS:	PAGE NO.
FIAT & IVECO CONTINUED			
1.860.992.000	SP23171-01	07763300	165
1.870.823.000	07764300	07764300	164
1.870.896.900	SP23174-04X	07751700	168
1.870.900.100	SP23069-53	07754500	156
1.870.900.300	SP23221	07751800	168
1.870.900.400	SP23222	07751800	168
1.871.000.200	SP23223	07751800	168
1.871.000.900	SP23171-02	07751800 07763300	168 165
1.895.443.000	SP23107-B	SP23107-B	227
1.895.879.000	SP23107-B	SP23107-B	227
2.000.012.000	SPE10290	07753900	167
2.000.012.100	SP23056-06	07753900	167
2.000.012.800	SPE10230	07753900	167
2.000.015.800	SP10229-01	07763300	165
2.000.016.500	SP310125007	07764500	169
2.000.016.700	SP310125009	07764500	169
2.000.016.900	SP310125001	07764500	169
2.000.017.000	SP310125005	07764500	169
2.000.017.100	SP310125006	07764500	169
2.000.017.300	SP310125010	07764500	169
2.000.018.200	SP23057	07751600	169
2.000.018.400	SP310125003	07764500	169
2.000.018.700	SP310125002	07764500	169
2.000.019.200	SP310125004	07764500	169
2.000.034.400	SP10441	07763200	165
2.000.035.100	SP310125003X	07763100	164
2.000.035.200	SP310125005X	07763100	164
2.000.035.300	SP310125001X	07763100	164
2.000.003.000	SP23111-08	07751700	168
2.000.004.200	SP23233	07751900	164
2.000.004.300	SP23234	07751900	164
2.000.004.400	SP23232	07751900	164
2.000.004.500	SP23231	07751900 07763200 07763300	164 165 165
2.190.754.200	SP23111-08	07751900	164
2.190.754.400	SP23232	07751900	164
2.190.754.500	SP23231	07751900	164
2.192.360.900	SP23164-22	07753700	167
99360614	SP23100-01	07751600 07764500	169 169
99360615	SP23100-02	07751600 07764500	169 169
FORD			
15-030A	07752400	07752400	229
21-104	SP23060-S	07752500 07752700	173 172
21-105	SP23062-B	07752700	172
21-162B	SP23054-06	077523V2 07752500 07752600 07752700	170 173 171 172
21-163	SP23054-03	077523V2 07752600 07755600 07764400	170 171 224 171
21-168A	SP23060-10	07752500 07752700 07752800 07762100	173 172 174 173
21-210	SP23054-02X	077523V2 07752600 07764400	170 171 171
21-229	SP23060-16	07752500	173

OEM REF.	PART NO.	SUPPLIED IN KITS:	PAGE NO.
FORD CONTINUED			
21-230	SP23060-18	07752500	173
21-234	SP23060-12	07752200 07752700	175 172
21-238	SP23175-02	07752200	175
21-251	SP23060-14	07752200 07752700	175 172
21-256	SP310125009	07764500	174
21-260	SP23069-04	07752200 07752700 07763900	175 172 175
21-262	SP23060-11	07752200 07752700 07763900	175 172 175
21-263	SP23069-25Z	07752800 07754100 07754300 07754400 07754500 07763900	174 159 158 160 156 175
23-019	SP23060-01	07752700	172
23-029	SP23069-35	07752700	172
23-047	SP23061-01	07752700	172
23-058	SP23069-12	077560V2 077562V2 07757200	147 144 142
23-059	SP23161-03	077560V2 077562V2 07757100	147 144 145
23-067	SP23060-17	07752500	173
205-072	07752400	07752400	229
303-095	SP23060-17	07752500	173
303-193	SP23060-S	07752500 07752700	173 172
303-249/1	07762400	07762400	229
303-367	SP23054-06	077523V2 07752500	170 173
303-376B	SP23054-06	077523V2 07752600 07752700 07764400	170 171 172 171
303-393	SP23060-10	07752500 07752700 07752800 07762100	173 172 174 173
303-393-01	SP23060-10C	07762100	173
303-393-02	SP23060-10B	07762100	173
303-507	SP23054-02X	077523V2 07752600	170 171
303-574	SP23054-03	077523V2 07752600 07755600 07764400	170 171 224 171
303-620	SP23054-03	077523V2 07752600 07755600 07764400	170 171 224 171
303-651	SP23060-16	07752500	173
303-652	SP23060-18	07752500	173
303-675	SP23060-12	07752200 07753600	175 178
303-679/A	07762500	07762500	229
303-698	SP23060-14	07752200 07752700	175 172
303-705	SP310125009	07764500	174
303-732	SP23069-04	07752200 07763900	175 175
303-734	SP23060-11	07752200 07752700 07763900	175 172 175
303-735	SP23069-25Z	07752700 07763900	172 175

OEM REF.	PART NO.	SUPPLIED IN KITS:	PAGE NO.
FORD CONTINUED			
303-748	SP23054-05	077523V2 07752600	170 171
303-1054	SP23161-94	077523V2 07752600	170 171
303-1059	SP23060-19	07752700	172
303-1059	SP23069-57	07752800 07764000	174 161
303-1061	SPE10450	07764400	171
303-1097	SP23060-21	07752600	171
303-1151	SP23175-01	07752200	175
303-1196	SP23060-70	SP23060-70	229
303-1270	SP23069-57	07752800 07764000	174 161
303-1272	SP23060-10	07752500 07752700 07752800 07762100	173 172 174 173
303-1277	SP23069-25Z	07752800	174
303-1310	07752900	07752900	229
303-1468	SP23221	07751800	172
303-1469	SP23222	07751800	172
303-1472	SP23171-02	07751800	172
303-1477	SP23233	07751900	170
303-1478	SP23234	07751900	170
303-1479	SP23232	07751900	170
303-1480	SP23231	07751900	170
310-083A	SP23002-45C	07752200	175
310-084	SP23069-12	077560V2 07757200	147 142
310-085	SP23161-03	077560V2 077562V2 07757100	147 144 145
IVECO			
SEE FIAT			
JAGUAR / LAND ROVER			
303-530	SP230330-02	07763000	177
303-531	SP230330-04	07763000	177
303-532	SP230330-01	07763000	177
303-588	SP23033-03 ABCD	07763000	177
303-645	SP230330-04	07763000	177
303-875	07766000	07766000	180
303-912	SP23048-01	07759000	180
303-936	02240000	02240000	179
303-947	SP23111-14	SP23111-14	179
303-960	07766000	07766000	180
303-970	SP23048-12	07759000	180
303-971	SP23048-09	07759000	180
303-972	SP23048-11	07759000	180
303-973	SP23078-04	07761000	179
303-986	SP23078-09	07761000	179
303-987	SP23078-01	07761000	179
303-1016	SP23048-36	07759000	180
303-1021	SP23078-08	07761000	179
303-1059	SP23069-57	07752800 07764000	180 161
303-1116	SP23079-02Z	07754200	177
303-1117	SP23079-03Y	07754200	177
303-1126	SP23061-21Z	07754200	177
303-1132	SP23079	07754200	177
303-1196	SP23060-70	SP23060-70	229
303-1270	SP23069-57	07752800 07764000	180 161



OEM REF.	PART NO.	SUPPLIED IN KITS:	PAGE NO.
JAGUAR / LAND ROVER CONT'D			
303-1272	SP23060-10	07752500 07752700 07752800 07762100	173 177 180 171
303-1277	SP23069-25Z	07752800 07754100 07754300 07754400 07754500 07763900	180 159 158 160 156 159
LRT 12-058	07766000	07766000	180
LRT 12-108	SP23048-01	07759000	180
LRT 12-112	SP23048-04	07758000	148
LRT 12-114	SP23048-07	07758000	148
LRT 12-115	SPE10369	07767000	152
LRT 12-134	02240000	02240000	179
LRT 12-145	SP23111-14	SP23111-14	179
LRT 12-158	07766000	07766000	180
LRT 12-172	SP23048-12	07759000	180
LRT 12-173	SP23048-09	07759000	180
LRT 12-174	SP23048-11	07759000	180
LRT 12-175	SP23078-04	07761000	179
LRT 12-187	SP23078-02	07761000	179
LRT 12-195	SP23078-09	07761000	179
LRT 12-196	SP23078-01	07761000	179
LRT 12-198	SP23078-07	07761000	179
LRT 12-227	SP23048-36	07759000	180
LRT 12-232	SP23078-08	07761000	179
MAZDA			
49JE01054	SP23054-06	077523V2 07764400	182 182
49JE01061	SP23054-02X	077523V2 07764400	182 182
49JE02018	SP23069-04	07763900	182
49JE02020	SP23060-11	07763900	182
49JE02021	SP23069-25Z	07752800 07754100 07754300 07754400 07754500 07763900	180 159 158 160 156 159
49UN205072	07752400	07752400	230
49UN30310610	SPE10450	07764400	182
49N010101	SP23054-03	077523V2 07752600 07755600 07764400	182 171 224 182
MERCEDES			
112589000100	07765000	07765000	183
112589003200	07765000	07765000	183
112589013200	07765000	07765000	183
111589031500	SP23241-03	07760000	184
601589024000	SP23241-01	07760000	184
602589004000	SP23241-01	07760000	184

OEM REF.	PART NO.	SUPPLIED IN KITS:	PAGE NO.
MG / ROVER			
12-170	SP23111-11	SP23111-11	206
12-171	SP23048-01	07759000	152
12-172	SP23048-12	07759000	152
12-173	SP23048-09	07759000	152
12-174	SP23048-11	07759000	152
12-175	SP23078-04	07761000	206
12-187	SP23078-02	07761000	206
18G 1570	02240000	02240000	206
18G 1571	SP23111-12	SP23111-12	206
18G 1742	SP23111-14	SP23111-14	206
18G 1746A	SP23078-07	07761000	206
18G 1747	SP23078-01	07761000	206
18G 1747-1	SP23078-09	07761000	206
18G 1747-5	SP23078-08	07761000	206
MINI (BMW)			
110 300	SP23069-25Z	07759300	186
113 340	SP23048-11Z	07758900	187
114 360	07763800	07763800	228
115 140	07763800	07763800	228
115 320	SP23048-37	07758900	187
116 480	SP23048-45	07758900	187
118 240	SP23180-03	07758300	185
118 250	SP23180-01	07758300	185
118 370	SP23180-02	07758300	185
118 740	SP23048-46	07758900	187
118 760	SP23048-35Z	07758900	187
119 330	07763800	07763800	228
119 340	SP23048-14	07758600	186
119 540	SP23048-26/27	07758600 07759400	186 185
119 550	SP23048-21	07758600 07759500	186 185
119 551	SP23048-27	07758600 07759500	186 185
119 552	SP23048-23	07758600 07759500	186 185
119 590	SP23048-24	07758600 07759400 07759500	186 185 185
119 790	SP23069-04	07759300	186
119 851/2	SPE10133	07759300	186
NISSAN			
KV1106030	07764900	07764900	189
KV113B0110	07755700	07755700	188
KV113B0130	07755700	07755700	188
MOT 1054	SP23069-23	07755200 07755700	188 188
MOT 1430	SP23069-25Z	07755200 07755700	188 188
MOT 1489	SP23054-04	07755100 07755200 07755700	188 188 188
MOT 1496	SP23069-52	07755100	188
MOT 1534	SP23164-20	07755200	188
MOT 1536	SP23164-18	07755200	188
MOT 1537	SP23164-19	07755200	188
MOT 1543	SP23069-59	07755200	188
MOT 1766	SP23069-79X	07755500	189
MOT 1769	SP23069-76	07755500	189
MOT 1770	SP23069-75Z	07755500	189
MOT 1773	SP23069-77	07755500	189

OEM REF.	PART NO.	SUPPLIED IN KITS:	PAGE NO.
PSA (CITROËN/PEUGEOT)			
0118-X	SP23061-11	07754400	160
0132-AB	SP23069-04	07754100 07754400 07754500	159 160 156
0132-AJ1	SP23069-25Z	07752800 07754100 07754300 07754400 07754500	180 159 158 160 156
0132-AJ2	SP23069-33	07754100 07754300	159 158
0132-AK	SP23069-53	07754100 07754300 07754500	159 158 156
0132-Q	SP23055-01	07754300	158
0132-QY	SPE10232	07754500	156
0132-QY	SP23055-01X	07754500	156
0132-QZ	SP23055-05	07754300	158
0132-R	SP23055-02	07754300	158
0132-RZ	SP23055-02X	07754500	156
0132-X	SP23053	07754300	158
0134-AF	SP23069-46	07754300 07754400	158 160
0134-C	SP23069-46	07754300 07754400	158 160
0134-Q	SP23069-46	07754300 07754400	158 160
0153-A	SP23111-02	07754300 07754400	158 160
0153-AA	SP23055-02X	07754500	156
0153-AB	SP23055-02X	07754500	156
0153-AK	SP23069-53	07754100 07754300 07754400 07754500	159 158 160 156
0153-AL	SP23069-33X	07754500 07764000	156 161
0153-G	SP23061-02	07754300 07754400	158 160
0153-N	SP23061-02	07754300 07754400	158 160
0153-Y	SP23061-02	07754300 07754400	158 160
0153-ZY	SP23055-02	07754300	158
0178-D	SP23069-04	07754500	156
0178-E	SP23069-44	07754400	160
0187-B	SP23069-25Z	07752800 07754100 07754300 07754400 07754500 07763900	180 159 158 160 156 159
0187-J	SP23069-53	07754100 07754300 07754400 07754500	159 158 160 156
0188-AD	SPE10095-02	07764000	161
0188-AH	SPE10095-01	07764000	161
0188-D	SP23061-02	07754300 07754400	158 160
0188-F	SP23061-24	07764000	161
0188-F	SP23069-46	07754400	160
0188-J2	SP23069-46Z	07764000	161
0188-K	SP23060-19Z	07764000	161
0188-K	SP23069-53	07754100 07754300 07754400 07754500	159 158 160 156



OEM REF.	PART NO.	SUPPLIED IN KITS:	PAGE NO.
VAUXHALL / OPEL CONTINUED			
KM-800-2	SP23047-03	07753500	192
KM-800-10	SP23047-01	07753500	192
KM-800-20	SP23047-02	07753500	192
KM-800-30	SP23047-05	07753500	192
KM-811	SP23048-04	07758000	148
KM-813	SP23048-01	07758000	148
KM-852	SP23058-01	07764600	191
KM.853	02290000	02290000	191
KM-911	SP23164-04	07753900	191
KM-911	SP23164-04Z	07753900 07764600	191 191
KM-927	SP23164-07	07753300	194
KM-929	SP23164-08	07753300	194
KM-932	SP23164-09	07753300	194
KM-933	SP23164-05/06	07753300	194
KM-952	SP23164-11	07753200 07763500	190 190
KM-953	SP23164-12	07753200	190
KM-953-A	SP23164-11EX	07763500	190
KM-954	SP23164-14	07753200	190
KM-955	SP23164-15	07753200	190
KM-955	SP23164-16	07753200	190
KM-955-1	SP23164-15Z	07763500	190
KM-955-2	SP23164-16Y	07763500	190
KM-6031	SP23069-23	07755100	192
KM-6077	SP23164-23	07753700	192
KM-6130	SP23174-01	07753900	191
KM-6130	SP23174-01Z	07764600	191
KM-6130	SP23069-78Z	07755500	193
KM-6148	SP23164-22	07753700	192
KM-6203	SP23164-18	07755200	195
KM-6204	SP23164-19	07755200	195
KM-6205	SP23164-20	07755200	195
KM-6233	SP23069-52	07755100	192
KM-6234	SP23069-59	07755200	195
KM-6333	SP23056-05	07753900	191
KM-6340	SP23056-06	07753900	191
KM-6347	SP23222	07751800	193
KM-6349	SP23174-01	07753900	191
KM-6349	SP23069-07X	07764700	194
KM-6625	SPE10230	07753900	191
KM-6628-A	SPE10290	07753900	191
VOLKSWAGEN GROUP			
2064	SP23061-01	077560V2 077564V2 07757900	147 222 220
2065A	SP23062-B	077560V2 077564V2 07757900	147 222 220
3036	07752400	07752400	230
3242	SP23056-01	077560V2 07757400 07757700 07757800 07762700	147 220 222 223 144
3355	SP23161-16	077564V2	222
3359	SP23069-11	077560V2 077562V2 07757100 07757700 07757800 07757900	147 221 221 222 223 220
3366	SP23161-92	07756700 07757200	220 219

OEM REF.	PART NO.	SUPPLIED IN KITS:	PAGE NO.
VOLKSWAGEN GROUP CONT'D			
3369	SP23161-07	077560V2 07757800	147 223
3387	SP23044-03	077560V2	147
3391	SP23056-B	07757400	220
3411	07756900	07756900	230
3415	07767100	07767100	231
3418	SP23161-B	077560V2 07757900	147 220
3458	SP23056-02	077560V2 07757800	147 223
MP-1-300	SP23062-B	077560V2 07757900	147 220
MP-1-312	SP23161-B	07757900	220
T10008	SP23069-12	077560V2 077562V2 07757200	147 221 219
T10016	07756014	077560V2	147
T10020	SP23044-04	07756700	220
T10020	07756005	07756005	231
T10025	SP23161-71	077564V2	222
T10050	SP23161-03	077560V2 077562V2 07757100	147 221 221
T10051	SP23161-61	07757100	221
T10052	SP23161-62	07757100	221
T10060/A	SP23161-96	077562V2 07756700 07757100 07757200 07757800	221 220 221 219 223
T10074	07756014	077560V2	147
T10092	SP23161-93	07756700 07757200	220 219
T10093	07756900	07756900	230
T10100	SP23161-03C	077560V2 077562V2 07757100	147 221 221
T10115	SP23161-94	077562V2	221
T10120	SP23176-02	07756100	218
T10121	SP23176-03	07756100	218
T10123	SP23176-01	07756100	218
T10170	SP23107-B	07763400	218
T10171/A	SP23162-41	07763400	218
T10172 /4	07763700	07763700	230
T10193	SP23270-01	07757600	223
T10199	SP23270-04	07757600	223
T10199/1	SP23270-05	07757600	223
T10221	07756081	07756081	231
T10222A	07756086	07756086	231
T10225	SP23162-82	07757600 07756082	223 231
T10226	SP23270-07	07757600	223
T10234	SP23270-08	07757600	223
T10252	SP23161-91	07756700	220
T10255	SP23161-17	07757100	221
T10264	SP23161-81	07756006 07757100	230 221
T10265	SP23161-83	07756006 07757100	230 221
T10340	SP23191-02X	07763400 07763600	218 218
T10341	SP23191-01	07763400	218
T10352/1	07757300	07757300	219
T10414	SPE10436	07763400 07763600	218 218
T20018	SP23161-92	07757200	219

OEM REF.	PART NO.	SUPPLIED IN KITS:	PAGE NO.
VOLKSWAGEN GROUP CONT'D			
T20038	SP23161-B	077560V2 07757900	147 220
T20046	SP23161-06	077560V2 07756300 07757200 07757800	147 143 219 223
T20102	SP23069-11	077560V2 077562V2 07757100	147 221 221
T20167	SP23161-96	077562V2 07756700 07757100 07757200 07757800	221 220 221 219 223
T40001	07757500	07757500	230
T40011	SP23161-06	077560V2 07756300 07756700 07757200 07757800 07762700 07763400	147 143 220 219 223 144 218
T40005	SP23069-12T	07762700	144
T40009	SP23161-96T	07762700	144
T40026	SP23162-71	07756300	143
T40028	SP23162-73	07756300	143
T40030	SP23162-72	07756300	143
T40049	SP23161-21Z	07757700	222
T40058	SP23161-95	07757700	222
T40060	SP23161-22	07757700	222
T40061	SP23161-23Z	07757700	222
T40062	SP23161-24Z	07757700	222
T40069	SP23162-62	07756800	143
T40070	SP23162-61	07756800	143
T40071	SP23162-63	07756800	143
T40098	07756006	07756006	230
T50009	SP23161-15	077564V2	222
U-20003	SP23061-01	077560V2 07757900	147 220
U-30009	SP23044-03	077560V2	147
U-40021	SP23062-B	077560V2 077564V2 07757900	147 222 220
U-40074	SP23069-11	077560V2	147
V.159	SP23044-01	077560V2	147
V.159	07756005	07756005	231
VAS 6079	SP23072-A	07712000 07763400	227 218
VOLVO			
999-5433	07764100	07764100	224
999-5452	SP23069-47	07755600	224
999-7119	SP23060-10	07752500 07752700 07752800	173 172 225
999-7120	SP23060-10	07752500 07752700 07752800	173 172 225
999-7121	SP23069-57	07752800 07764000	225 161
999-7122	SP23069-25Z	07752800 07763900	225 225
999-7169	SP23069-04	07763900	225
999-7151	SP23054-06	077523V2	224
999-7152	SP23054-05	077523V2	224
999-7201	SP23054-03	077523V2	224
999-7406	SP23054-05	077523V2 07755600	224 224
999-7429	SP23060-21	07752600	171



FOR THE LATEST
PRODUCT INFORMATION
VISIT OUR NEW WEBSITE:

www.sykes-pickavant.com